

Comprehensive Cervical Cancer Control

A guide to essential practice

Second edition



World Health
Organization

Comprehensive cervical cancer control

A guide to essential practice



**World Health
Organization**

WHO Library Cataloguing-in-Publication Data

Comprehensive cervical cancer control: a guide to essential practice – 2nd ed

1.Uterine Cervical Neoplasms - diagnosis. 2.Uterine Cervical Neoplasms - prevention and control. 3.Uterine Cervical Neoplasms – therapy. 4.Guideline.
I.World Health Organization.

ISBN 978 92 4 154895 3

(NLM classification: WP 480)

© World Health Organization 2014

All rights reserved. Publications of the World Health Organization are available on the WHO website (www.who.int) or can be purchased from WHO Press, World Health Organization, 20 Avenue Appia, 1211 Geneva 27, Switzerland (tel.: +41 22 791 3264; fax: +41 22 791 4857; e-mail: bookorders@who.int).

Requests for permission to reproduce or translate WHO publications –whether for sale or for non-commercial distribution– should be addressed to WHO Press through the WHO website (www.who.int/about/licensing/copyright_form/en/index.html).

The designations employed and the presentation of the material in this publication do not imply the expression of any opinion whatsoever on the part of the World Health Organization concerning the legal status of any country, territory, city or area or of its authorities, or concerning the delimitation of its frontiers or boundaries. Dotted and dashed lines on maps represent approximate border lines for which there may not yet be full agreement.

The mention of specific companies or of certain manufacturers' products does not imply that they are endorsed or recommended by the World Health Organization in preference to others of a similar nature that are not mentioned. Errors and omissions excepted, the names of proprietary products are distinguished by initial capital letters.

All reasonable precautions have been taken by the World Health Organization to verify the information contained in this publication. However, the published material is being distributed without warranty of any kind, either expressed or implied. The responsibility for the interpretation and use of the material lies with the reader. In no event shall the World Health Organization be liable for damages arising from its use.

Printed in

Acknowledgements

The World Health Organization (WHO) would like to thank the members of the Guideline Development Group for their constant availability and hard work on developing this updated guideline. WHO is also grateful to the Methods Group from McMaster University and the External Review Group for their essential contributions. The names of the participants in each group, as well as those of the writers and editor involved in this project are listed in Annex 1.



Participants and contributors

WHO also wishes to express sincere gratitude for the financial contributions from the following agencies; without this support, the production of this guide would not have been possible:

- Centers for Disease Control and Prevention (CDC; Atlanta, GA, USA)
- Flanders International Cooperation Agency (FICA)
- GAVI Alliance
- Health Canada, through the Canadian Partnership Against Cancer (Toronto, Canada)
- Institut National du Cancer (INCa; Paris, France)
- United States President's Emergency Plan for AIDS Relief (PEPFAR; Washington, DC, USA)

Endorsing organizations



International Agency for Research on Cancer



WHO Coordinating Team

Nathalie Broutet

Reproductive Health and Research

WHO Headquarters

Geneva, Switzerland

Linda O'Neal Eckert

Department of Obstetrics and Gynecology

University of Washington

Seattle, WA, USA

Andreas Ullrich

Management of Noncommunicable Diseases

WHO Headquarters

Geneva, Switzerland

Paul Bloem

Immunization, Vaccines and Biologicals

WHO Headquarters

Geneva, Switzerland

Contents

Acknowledgements	iii
Acronyms and abbreviations	1
Compilation of key points	3
Preface	8
Introduction	11
About the guide	11
Levels of the health-care system	18
Essential reading.....	19
Chapter 1. Background	23
About this chapter	25
1.1 Why focus on cervical cancer?	26
1.2 Female pelvic anatomy and physiology	29
1.3 Natural history of cancer of the cervix	38
Further reading	44
Chapter 2. Essentials for cervical cancer prevention and control programmes	47
About this chapter	49
2.1 What is a comprehensive cervical cancer prevention and control programme?	51
2.2 National cervical cancer prevention and control programmes.....	54
2.3 Achieving cervical cancer prevention and control.....	78
Further reading	79
Chapter 3. Community mobilization, education and counselling	81
About this chapter	83
3.1 Increasing the use of cervical cancer prevention and control services	84
3.2 Outreach	86
3.3 Community mobilization	88
3.4 Preventive health education.....	90
3.5 Counselling	99
Further reading	103

Chapter 4. HPV vaccination	105
Key WHO Recommendations on HPV vaccines	108
About this chapter	108
4.1 Roles of health-care providers and others	111
4.2 HPV vaccines.....	113
4.3 Target population and delivery strategies	118
4.4 Community mobilization	122
4.5 Obtaining consent/assent for a girl to get vaccinated	122
4.6 Monitoring and evaluation and sustainability of HPV vaccination programmes.....	123
Further reading	127
Chapter 5. Screening and treatment of cervical pre-cancer	129
About this chapter	132
5.1 Health-care providers	134
5.2 Cervical cancer screening	135
5.3 Screening methods for cervical pre-cancer.....	141
5.4 Diagnostic tests for detection of cervical pre-cancer.....	150
5.5 Treatment options for cervical pre-cancer.....	154
5.6 Possible complications and follow-up after treatment	160
5.7 Linking screening and treatment in practice	161
Chapter 6. Diagnosis and treatment of invasive cervical cancer	165
About this chapter	167
6.1 Presentation and diagnosis of cervical cancer.....	170
6.2 The role of the health-care provider	171
6.3 Cervical cancer staging	174
6.4 Treatment of invasive cervical cancer: overview	178
6.5 Treatment options.....	180
6.6 Special situations: cervical cancer in pregnancy and in women living with HIV	186
6.7 Patient support and follow-up.....	187
Further reading	190
Chapter 7. Palliative care.....	191
About this chapter	193
7.1 A comprehensive approach to palliative care	196
7.2 The role of the family in palliative care.....	199
7.3 The roles of health-care providers	200
7.4 Managing common symptoms in advanced cervical cancer	205
7.5 Keeping the patient and her support circle informed	208
Further reading	213

Practice sheets

Practice Sheet 2.1: Checklist for planning and implementing a cervical cancer prevention and control programme	217
Practice Sheet 2.2: Key performance and impact indicators for national cervical cancer prevention and control programmes.....	218
Practice Sheet 3.1: Key messages for cervical cancer outreach and education ..	222
Practice Sheet 3.2: Frequently asked questions (FAQs) about cervical cancer	225
Practice Sheet 3.3: What men need to know to help prevent cervical cancer.....	230
Practice Sheet 3.4: Counselling	232
Practice Sheet 3.5: Standard counselling steps for before, during and after a client has a test, procedure or treatment	235
Practice Sheet 3.6: Special counselling for women living with HIV	236
Practice Sheet 3.7: Working with community health workers: how to recruit and train	237
Practice Sheet 4.1: Frequently asked questions (FAQs) about HPV vaccination ...	239
Practice Sheet 4.2: HPV vaccine characteristics and the cold chain.....	244
Practice Sheet 4.3: The immunization session	247
Practice Sheet 4.4: Injection safety.....	250
Practice Sheet 4.5: Monitoring and evaluation of vaccination programmes – data collection and documentation.....	251
Practice Sheet 4.6: In case of an adverse event following immunization (AEFI) ..	253
Practice Sheet 4.7: Talking with teachers and school officials about HPV vaccination.....	255
Practice Sheet 5.1: Obtaining informed consent from adult women.....	258
Practice Sheet 5.2: Taking a history and performing a pelvic examination.....	260
Practice Sheet 5.3: Screening methods: notes for the provider.....	265
Practice Sheet 5.4: Molecular screening method – HPV DNA testing	266
Practice Sheet 5.5: Visual screening method – visual inspection with acetic acid (VIA)	269

Practice Sheet 5.6: Cytology-based screening methods – Pap smear and liquid-based cytology (LBC)	272
Practice Sheet 5.7: Counselling women after positive screening test results	277
Practice Sheet 5.8: Colposcopy	280
Practice Sheet 5.9: Biopsy and endocervical curettage (ECC).....	284
Practice Sheet 5.10: Treatment options for cervical pre-cancer: cryotherapy.....	289
Practice Sheet 5.11: Treatment options for cervical pre-cancer: loop electrosurgical excision procedure (LEEP).....	293
Practice Sheet 5.12: Treatment options for cervical pre-cancer: cold knife conization (CKC)	298
Practice Sheet 6.1: When a patient consults you because she has symptoms that may be due to cervical cancer.....	302
Practice Sheet 6.2: Informing a patient about a diagnosis of cervical cancer, and talking about it with the patient and her support circle.....	304
Practice Sheet 6.3: Providing advance information to patients with cervical cancer about what may take place at the hospital	306
Practice Sheet 6.4: Talking to a patient about her cancer and treatment: suggestions for tertiary-level health-care providers (cancer specialists).....	307
Practice Sheet 6.5: Treatments for cervical cancer: hysterectomy	310
Practice Sheet 6.6: Treatments for cervical cancer: pelvic teletherapy.....	315
Practice Sheet 6.7: Treatments for cervical cancer: brachytherapy.....	321
Practice Sheet 7.1: Evaluation and treatment of pain	324
Practice Sheet 7.2: How to manage vaginal discharge, fistulae and bleeding at home	330
Practice Sheet 7.3: Conversations with a patient who is returning home under palliative care.....	333

Annexes

Annex 1. Lists of participants and contributors.....	335
Annex 2. Guideline development methodology, roles of the technical and working groups, and management and declarations of conflicts of interest	343
Annex 3. Infection prevention and control	350
Annex 4. Cancer and pre-cancer classification systems	353
Annex 5. The 2001 Bethesda System	355
Annex 6. HPV immunization sample forms	357
Sample Form 6.1: Girl's personal HPV vaccination card	357
Sample Form 6.2: HPV vaccine coverage monitoring forms for vaccine providers at the service delivery site level.....	358
Sample Form 6.3: Reporting of national HPV vaccine coverage for the WHO–UNICEF joint reporting form	360
Sample Form 6.4: Reporting of adverse events following immunization (AEFIs).....	361
Annex 7. Decision-making flowchart for screen-and-treat strategies	363
Annex 8. Flowcharts for screen-and-treat strategies (negative or unknown HIV status).....	364
Screen with an HPV test and treat with cryotherapy, or LEEP when not eligible for cryotherapy.....	364
Screen with an HPV test followed by VIA and treat with cryotherapy, or LEEP when not eligible for cryotherapy	365
Screen with VIA and treat with cryotherapy, or LEEP when not eligible for cryotherapy.....	366
Screen with an HPV test followed by colposcopy (with or without biopsy) and treat with cryotherapy, or LEEP when not eligible for cryotherapy	367
Screen with cytology followed by colposcopy (with or without biopsy) and treat with cryotherapy, or LEEP when not eligible for cryotherapy.....	368
Annex 9. Flowcharts for screen-and-treat strategies (HIV-positive status or unknown HIV status in areas with high endemic HIV infection).....	369
Screen with an HPV test and treat with cryotherapy, or LEEP when not eligible for cryotherapy.....	369

Screen with an HPV test followed by VIA and treat with cryotherapy, or LEEP when not eligible for cryotherapy..... 370

Screen with VIA and treat with cryotherapy, or LEEP when not eligible for cryotherapy..... 371

Screen with an HPV test followed by colposcopy (with or without biopsy) and treat with cryotherapy, or LEEP when not eligible for cryotherapy..... 372

Screen with cytology followed by colposcopy (with or without biopsy) and treat with cryotherapy or LEEP (when not eligible for cryotherapy) 373

Annex 10. Cervical cancer treatment by FIGO stage..... 374

Annex 11. Sample documents 376

Sample Form 11.1: Sample letter to patient with an abnormal screening test who did not return for results or treatment at the expected time 376

Sample Form 11.2: Sample card that can be used as part of a system < to track patients who need a repeat screening test..... 377

Sample Form 11.3: Sample card that can be used as part of a system to track patients referred for further diagnostic evaluation 378

Sample Form 11.4: Sample letter informing referring clinic of the outcome of a patient's diagnostic evaluation..... 379

Annex 12. Treatment of cervical infections and pelvic inflammatory disease 380

Annex 13. How to make Monsel's paste 382

Annex 14. Pathology reporting for cervical carcinoma 384

Sample Form 14.1: Radical hysterectomy reporting form..... 385

Glossary 386

Acronyms and abbreviations

ABHR	alcohol-based handrub
AEFI	adverse event following immunization
AGC	atypical glandular cells
AIS	adenocarcinoma in situ
ASC	atypical squamous cells
ASC-H	atypical squamous cells: cannot exclude a high-grade squamous (intra) epithelial lesion
ASCUS	atypical squamous cells of undetermined significance
C4GEP	comprehensive cervical cancer control: a guide to essential practice
C4P	cervical cancer prevention and control costing tool
CD4	cluster of differentiation 4
CDC	Centers for Disease Control and Prevention (United States of America)
CHP	community health promoter
CHW	community health worker
CIN	cervical intraepithelial neoplasia
CKC	cold knife conization
CT	computerized tomography
DOI	declaration of interest
DTP	diphtheria, tetanus and pertussis
ECC	endocervical curettage
ERG	External Review Group
FAQ	frequently asked question
FICA	Flanders International Cooperation Agency
FIGO	International Federation of Gynecology and Obstetrics
GAVI	GAVI Alliance (formerly the Global Alliance for Vaccines and Immunisation)
GDG	Guideline Development Group
GRADE	Grading of Recommendations Assessment, Development and Evaluation
GSK	GlaxoSmithKline
HCT	HIV counselling and testing
HDR	high dose rate
HPV	human papillomavirus
HSIL	high-grade squamous intraepithelial lesion
IARC	International Agency for Research on Cancer
ICD	International Classification of Diseases
IEC	information, education and communication
INCa	Institut National du Cancer
IPC	infection prevention and control

IUD	intrauterine device
Jhpiego	an affiliate of Johns Hopkins University (formerly Johns Hopkins Program for International Education in Gynecology and Obstetrics)
LBC	liquid-based cytology
LDR	low dose rate
LEEP	loop electrosurgical excision procedure
LSIL	low-grade squamous intraepithelial lesion
M&E	monitoring and evaluation
MIS	management information system
MMT	multidisciplinary management team
MOH	ministry of health
MRI	magnetic resonance imaging
MSD	Merck Sharp & Dohme Corp.
NCI	National Cancer Institute of the NIH (United States of America)
NIH	National Institutes of Health (United States of America)
NITAG	national immunization technical advisory group
NSAID	non-steroidal anti-inflammatory drug
OC	oral contraceptives
PAHO	Pan American Health Organization
Pap	Papanicolaou
PATH	international nonprofit organization (formerly the Program for Appropriate Technology in Health)
PEPFAR	United States President's Emergency Plan for AIDS Relief
PID	pelvic inflammatory disease
PIE	post-introduction evaluation
PPE	personal protective equipment
PS	practice sheet
SAGE	Strategic Advisory Group of Experts on Immunization
SCJ	squamocolumnar junction
SPMSD	Sanofi Pasteur MSD
STI	sexually transmitted infection
UICC	Union for International Cancer Control
UNAIDS	Joint United Nations Programme on HIV/AIDS
UNICEF	United Nations Children's Fund
VIA	visual inspection with acetic acid
VLP	virus-like particles
VVM	vaccine vial monitor
WHA	World Health Assembly
WHO	World Health Organization

Compilation of key points

Chapter 1. Background

- Cervical cancer is a largely preventable disease, but worldwide it is one of the leading causes of cancer death in women. Most deaths occur in low- to middle-income countries.
- The primary cause of cervical pre-cancer and cancer is persistent or chronic infection with one or more of the “high-risk” (or oncogenic) types of human papillomavirus (HPV).
- HPV is the most common infection acquired during sexual relations, usually early in sexual life.
- In most women and men who become infected with HPV, these infections will resolve spontaneously.
- A minority of HPV infections persist; in women this may lead to cervical pre-cancer, which, if not treated, may progress to cancer 10 to 20 years later.
- Women living with HIV are more likely to develop persistent HPV infections at an earlier age and to develop cancer sooner.
- Basic knowledge of women’s pelvic anatomy and the natural history of cervical cancer gives health-care providers at primary and secondary levels the knowledge base to effectively communicate and raise the understanding of cervical cancer prevention in women, families and communities.

Chapter 2. Essentials for cervical cancer prevention and control programmes

- Development of any national cervical cancer prevention and control programme should be done in accordance with the WHO framework of the “six building blocks” to strengthen the overall health system.
- Cervical cancer prevention and control programmes are developed and designed to decrease cervical cancer incidence, morbidity and mortality.
- There are large inequities in access to effective cervical cancer screening and treatment; invasive cervical cancer predominantly affects women who lack access to these services.
- A comprehensive programme should include primary, secondary and tertiary prevention activities (including treatment), and access to palliative care.
- Screening services must be linked to treatment and post-treatment follow-up.
- Monitoring and evaluation are essential components of cervical cancer prevention and control programmes.

Chapter 3. Community mobilization, education and counselling

- Outreach, community mobilization, health education and counselling are essential components of an effective cervical cancer prevention and control programme to ensure high vaccination coverage, high screening coverage and high adherence to treatment.
- Outreach strategies must reach and engage young girls and women who would most benefit from vaccination and screening, respectively, as well as men and boys and leaders in the community, and key stakeholders.
- Community mobilization and health education are essential tools for overcoming common challenges that impede access to and utilization of preventive care; these common barriers include social taboos, language barriers, lack of information and lack of transportation to service sites.
- Health education ensures that women, their families and the community at large understand that cervical cancer is preventable.
- Health education messages about cervical cancer should reflect the national policy and should be culturally appropriate and consistent at all levels of the health system.
- Health-care facilities should have a private room that can be used to provide individual women with information and counselling, if appropriate, to help them make the best choices for their health.
- Health-care providers should be trained to discuss sexuality in a nonjudgemental way and to address issues related to cervical cancer and human papillomavirus (HPV) while protecting patient privacy and confidentiality.
- It is critical that educational messages emphasize that women with abnormal screening results must return for follow-up.

Chapter 4. HPV vaccination

- Human papillomavirus (HPV) is the most common sexually transmitted infection (STI).
- Cervical cancer is caused by high-risk types of HPV; the two high-risk HPV types that most commonly cause cervical cancer are types 16 and 18, which together are responsible for approximately 70% of cervical cancer cases in all countries around the world.
- Two vaccines that prevent infections from high-risk HPV types 16 and 18 are presently licensed in most countries; they both have excellent safety records and may be safely co-administered with other vaccines, such as those for diphtheria, tetanus and pertussis (DTP) and hepatitis B.
- One of the HPV vaccines, the quadrivalent vaccine, also prevents infections from HPV types 6 and 11, which cause 90% of anogenital warts or condyloma.

- Vaccinating girls before initiation of sexual activity is an important primary prevention intervention in a comprehensive cervical cancer prevention and control programme.
- The vaccines do not treat pre-existing HPV infection or HPV-associated disease, which is why vaccination is recommended prior to initiation of sexual activity.
- Because the vaccines do not protect against all HPV types that can cause cervical cancer, girls vaccinated against HPV will still require cervical cancer screening later in their lives.

Chapter 5. Screening and treatment of cervical pre-cancer

- Early detection, by screening all women in the target age group, followed by treatment of detected precancerous lesions can prevent the majority of cervical cancers.
- Cervical cancer screening should be performed at least once for every woman in the target age group where most benefit can be achieved: 30–49 years.
- Cervical cancer screening, at least once, is recommended for every woman in the target age group, but this may be extended to women younger than age 30 if there is evidence of a high risk for CIN2+.
- HPV testing, cytology and visual inspection with acetic acid (VIA) are all recommended screening tests.
- For cervical cancer prevention to be effective, women with positive screening test results must receive effective treatment.
- It is recommended to take either a “screen-and-treat” approach or a “screen, diagnose and treat” approach.
- Decisions on which screening and treatment approach to use in a particular country or health-care facility should be based on a variety of factors, including benefits and harms, potential for women to be lost to follow-up, cost, and availability of the necessary equipment and human resources.
- In the screen-and-treat approach, the treatment decision is based on a screening test and treatment is provided soon or, ideally, immediately after a positive screening test (i.e. without the use of a diagnostic test).
- The screen-and-treat approach reduces loss to follow-up, and can reduce the time lag for women to receive treatment.
- Among women who test negative with VIA or cytology, the interval for re-screening should be three to five years.
- Among women who test negative with HPV testing, re-screening should be done after a minimum interval of five years.
- If cancer is suspected in women who attend screening, they should not be treated but should be referred to a facility for diagnosis and treatment of cancer.

- Cryotherapy or loop electrosurgical excision procedure (LEEP) can provide effective and appropriate treatment for the majority of women who screen positive for cervical pre-cancer.

Chapter 6. Diagnosis and treatment of invasive cervical cancer

- Women diagnosed with early invasive cervical cancer can usually be cured with effective treatment.
- It is important for health-care providers at all levels to be able to recognize and promptly manage common symptoms and signs of cervical cancer.
- The definitive diagnosis of invasive cervical cancer is made by histopathological examination of a biopsy.
- Women with invasive cervical cancer benefit from referral for treatment at tertiary-level cancer facilities.
- Treatment options include surgery, radiotherapy and chemotherapy; these may be used in combination.
- Patients should be made aware of the potential side-effects of treatment, such as infertility, menopause, discomfort or pain with intercourse and possible bowel or bladder changes.
- Patients need to be informed that they will need long-term follow-up and contact with the cancer unit where they received their treatment.
- Tertiary-level providers should send complete written records of the treatment and ongoing care plan to providers closest to the patient's home who will be charged with facilitating her follow-up care.
- If left untreated, invasive cervical cancer is almost always fatal.

Chapter 7. Palliative care

- Palliative care is an essential element of cervical cancer control.
- Palliative care improves the quality of life of patients and their families facing the problems associated with life-threatening illness.
- Palliative care consists of the prevention and relief of suffering by means of early identification and assessment and treatment of pain and other forms of physical, psychosocial and spiritual suffering.
- Palliative care can help people with advanced disease to have dignity and peace during difficult and final phases of life.
- Palliative care is best provided using a multidisciplinary team approach involving the patient, her family and close support persons, community health workers and special palliative care workers in the community, as well as health-care providers at all levels of facilities.

- The mechanisms for palliative care implementation, including education and the availability of medicines, need to be strengthened.
- Using a broad combination of medical and nonmedical methods, most pain can be effectively controlled.
- Nurses with appropriate training should be allowed to prescribe strong oral opioids, subject to the national norms and guidelines.
- Quality of palliative care very much depends on adequate training and supervision for health care providers and, if possible, for community-based caregivers.
- Access to all necessary medicines, equipment and supplies is critical for symptom management, both at the health-care facility and in the patient's home.

Preface

Cervical cancer is one of the gravest threats to women's lives. It is estimated that over a million women worldwide currently have cervical cancer. Most of these women have not been diagnosed, nor do they have access to treatment that could cure them or prolong their lives. In 2012, 528 000 new cases of cervical cancer were diagnosed, and 266 000 women died of the disease, nearly 90% of them in low- to middle-income countries. Without urgent attention, deaths due to cervical cancer are projected to rise by almost 25% over the next 10 years.

Cervical cancer occurs worldwide, but the highest incidence rates are found in Central and South America, East Africa, South and South-East Asia, and the Western Pacific. Over the past three decades, cervical cancer rates have fallen in most of the developed world, largely as a result of screening and treatment programmes. In contrast, rates in most developing countries have risen or remained unchanged. Major disparities also exist in the developed world, where rural and poorer women are at greatest risk of invasive cervical cancer.

Most women who die from cervical cancer, particularly in developing countries, are in the prime of their lives. They may be raising children, caring for their families and contributing to the social and economic lives of their towns and villages. A woman's death is both a personal tragedy and a sad and unnecessary loss to her family and her community, with enormous repercussions for the welfare of both. These deaths are unnecessary because there is compelling evidence that cervical cancer is one of the most preventable and treatable forms of cancer if it is detected early and managed effectively.

While less developed countries are clearly more likely to lack effective health systems and adequate financial resources compared with developed countries, it is crucial to underscore that another of the most overlooked but powerful drivers of cervical cancer is lack of equality for women in terms of access to health care in many societies. We can address the needs for adequate resources and improved health care for women in developing countries. And we can also seek to better understand gender inequality and take it into account in the design of health policies and programmes, as well as other important social determinants of health, such as wealth, education, religion and ethnicity.

In 2007, as a matter of policy, the World Health Assembly adopted a resolution that committed the World Health Organization (WHO) and its Member States to the process of gender mainstreaming. Gender mainstreaming refers to the systematic process of understanding gender and taking it into account in the design, implementation and

evaluation of all policies and programmes. This knowledge and action is an essential component of developing equitable and accessible programmes, including innovative ways of reaching women, especially the most disadvantaged.

While continuing to advocate for greater attention and resources for women's health, beyond addressing maternal care and family planning, WHO is also actively involved in strengthening health systems in general, and in developing, testing and implementing appropriate technologies to make comprehensive cervical cancer care feasible and affordable in low- and middle-income countries. New technological developments offer the potential to tackle cervical cancer in a more comprehensive way and build a healthier future for girls and women. The increasing availability of alternative screening technologies, such as visual inspection with acetic acid (VIA) and HPV testing, and new vaccines against human papillomavirus (HPV) can help to prevent a great many cases of cervical cancer. Moreover, because HPV vaccination targets girls between the ages of 9 and 13, before they become sexually active, there is the opportunity to launch a life-course approach to cervical cancer prevention and control, starting from childhood and continuing through adulthood, with screening recommended between the ages of 30 and 49.

Implementation of cervical cancer prevention and control programmes expands universal access to sexual and reproductive health services that improve women's health. This in turn contributes to the attainment of the Millennium Development Goals and the future international development agenda beyond 2015. These programmes also contribute to the United Nations Secretary-General's 2010 Global Strategy for Women's and Children's Health.

In addition, cervical cancer is highlighted in the 2011 Political Declaration of the High-Level Meeting of the General Assembly on the Prevention and Control of Non-communicable Diseases (NCDs). At the World Health Assembly in 2013, an action plan for the prevention and control of NCDs 2014–2020 was agreed with Member States; in this action plan, cervical cancer control is among the priority interventions to be universally recommended for cancer control. WHO leads the process of implementing this NCD action plan, and Member States are now committed to including cervical cancer and other NCD interventions in their national health plans.

There are multiple opportunities to integrate cervical cancer prevention and control into existing health care delivery systems, such as reproductive health and HIV/AIDS programmes. National cervical cancer prevention and control programmes offer a model for collaboration among several programmes, including reproductive health, NCD and cancer, immunization and adolescent health. These national programmes could thus catalyse changes in the planning and delivery of health care, supporting a transition from vertical approaches to horizontal systems.

This publication, *Comprehensive cervical cancer control: a guide to essential practice* (C4GEP), gives a broad vision of what a comprehensive approach to cervical cancer prevention and control means. In particular, it outlines the complementary strategies for comprehensive cervical cancer prevention and control, and highlights the need for collaboration across programmes, organizations and partners. This new guide updates the 2006 edition and includes the recent promising developments in technologies and strategies that can address the gaps between the needs for and availability of services for cervical cancer prevention and control.

Dr Flavia Bustreo
Assistant Director-General
Family, Women's and Children's Health

Dr Marie-Paule Kieny
Assistant Director-General
Health Systems and Innovation

Dr Oleg Chestnov
Assistant Director-General
Noncommunicable Diseases and Mental Health

Introduction

About the guide

This is the 2014 edition of *Comprehensive cervical cancer control: a guide to essential practice* (C4GEP), which has been revised and updated from the 2006 edition.

Why revision was important

In the last few years, there has been an emergence of ground-breaking new strategies in cervical cancer prevention and control. Because such strategies require evidence-based evaluation for decision-making in clinical practice and programme planning, a World Health Organization (WHO) Steering Committee and a group of invited experts met in Geneva, Switzerland, in September 2010, to ensure that the WHO's guidance on cervical cancer continues to encompass all the relevant technologies and strategies. Annex 1 provides the lists of participants and contributors, and Annex 2 describes the guideline development methodology, the roles of the technical and working groups and the management of conflicts of interest and presents the declarations of interests.



Participants and contributors



Guideline development methods and roles

This revised C4GEP includes WHO recommendations on screening and treatment of pre-cancer lesions and on HPV vaccination made through April 2014, taking account of relevant evidence-based findings published up to December 2013; emerging practices that are still being evaluated are also noted in this publication.

This guide has two new chapters, one newly organized chapter, and two substantially revised chapters. All chapters have been thoroughly updated and edited as needed.

The new chapters are:

Chapter 2: Essentials for cervical cancer prevention and control programmes.

In response to requests from programme managers and other readers at all levels of health care, WHO has included this entirely new chapter which describes key aspects of programmatic considerations associated with cervical cancer prevention and control programmes: planning, preparing, implementing, monitoring and evaluating, supervising and training.

Chapter 4: HPV vaccination. This chapter provides a detailed description of HPV vaccination programmes for girls aged 9–13 years. Such programmes did not exist in developing countries at the time of the first edition, but today they are found in more and more countries. This chapter also includes a set of three key WHO recommendations on HPV vaccines.

The reorganized chapter is:

Chapter 5: Screening and treatment of cervical pre-cancer. Chapter 5 now consolidates information from what were two chapters: screening for cervical pre-cancer and treatment for cervical pre-cancer. This consolidation was done because screening without treatment of pre-cancer is not an intervention that will reduce the incidence of cervical cancer or the associated mortality. Additionally, research on the screen-and-treat approach to cervical cancer prevention and control has markedly advanced since the last edition of this guide.

The two other substantially revised chapters are:

Chapter 6 (Diagnosis and treatment of invasive cervical cancer) and Chapter 7 (Palliative care). These chapters do not include WHO recommendations because WHO guidelines on these subjects are currently being prepared. These two chapters have been revised to reflect the current available evidence.

Scope and objectives

This guide's principal objective is to assist those responsible for providing services aimed at reducing the burden of cervical cancer on women, their communities and health systems. It focuses on the knowledge, best practices and communication skills needed by health-care providers working at community and primary and secondary levels of care to offer quality services for prevention, screening, treatment and palliative care for cervical cancer: the full continuum of care.

The four levels of care referred to throughout this guide are:

- Community
- Health centre or primary care level
- District hospital or secondary care level
- Central or referral hospital or tertiary care level.

A description of each level is given on page 16 (Levels of the health-care system).

Target audience

This guide is intended primarily for health-care providers in health centres and district hospitals who deal with women's health and/or adolescent's health. It may also be of interest to community-based and tertiary-level providers.

A second target audience, particularly for Chapter 2 on programme essentials, includes providers and managers at the subnational level whose responsibilities may include programme planning, implementation, monitoring and evaluating, and/or supervising and training other health-care providers.

National-level decision-makers will find updated evidence-based information in this guide on what works in cervical cancer prevention and control programmes, which may be of use as a basis for updating their own guidelines and protocols.

Language used in the guide

The language throughout the guide has intentionally been adapted for the primary target audience: primary- and secondary-level workers whose ultimate beneficiaries are their clients, patients and communities. It avoids technical jargon when describing tertiary-level procedures and services provided by specialists. Instead, it provides the tools to explain and discuss basic issues with patients and their support circles so they can understand and make informed decisions. Technical terms used in this guide that may be unfamiliar to the reader are defined in the glossary.

Structure of the guide

This guide consists of seven chapters:

Chapter 1: Background

Chapter 2: Essentials for cervical cancer prevention and control programmes

Chapter 3: Community mobilization, education and counselling

Chapter 4: HPV vaccination

Chapter 5: Screening and treatment of cervical pre-cancer

Chapter 6: Diagnosis and treatment of invasive cervical cancer

Chapter 7: Palliative care

Each **chapter** contains comprehensive, need-to-know information on an aspect of cervical cancer prevention and/or control. The contents of each chapter are organized as follows:

- key points from the material covered in the chapter;
- a description of the roles and responsibilities of primary- and secondary-level providers in relation to the topic of the chapter;
- essential background information on the topic, followed by discussion of established and evolving practices in clinical care, and recommendations for practice, as appropriate (this section presents the basic information and skills that will enable the provider to offer good quality, up-to-date services);
- guidance and suggestions about how to counsel and communicate with patients, families and communities;

- information on services at each of the four levels of the health-care system, where applicable;
- counselling messages to help providers communicate with patients about the services they have received and the follow-up they will need (Chapters 6 and 7 contain suggestions intended to assist specialist providers at tertiary-level facilities to have effective two-way conversations with patients, their families and support circles);
- a list of further reading.

The **practice sheets**, provided after the chapters, are designed as:

- reminders for providers on the important elements to include when describing, providing counselling about, and/or performing a specific procedure or component of care (including answers to many frequently asked questions); and/or
- checklists to help providers assure the availability of necessary items before starting an activity (e.g. before conducting an HPV vaccination session), or to document competency as part of supportive supervision (e.g. the correct way to perform cryotherapy).

The chapters on cervical cancer treatment and palliative care (Chapters 6 and 7) are supplemented by practice sheets for trained lower- and mid-level providers so that they have clear information as a basis for explaining to patients and their families what services they can expect at specialist hospitals when they are referred for further testing and/or treatment.

The practice sheets can be individually copied or adapted. Please note that they are not intended to be used by a novice as a way of learning to carry out a procedure.

The **annexes** at the end of the guide provide details on specific practice components, using internationally established protocols (e.g. management flowcharts and treatment protocols) and strategies to ensure service quality (e.g. infection prevention and control).

The **glossary** contains definitions of scientific and technical terms used in the guide.

The health-care team

In an ideal cervical cancer prevention and control programme, providers work as a team in a complementary and synergistic way, maintaining good communication within and between levels of care. In some countries, the private and nongovernmental sectors are important providers of services for cervical cancer. Efforts to integrate them, as well as professional organizations representing a range of providers (such as associations of general practitioners, gynaecologists, paediatricians, public health specialists and vaccinologists), can be valuable for extending the reach of services and ensuring that similar protocols and standards

are applied. With the increasing availability of HPV vaccines in more countries, paediatricians and educators also play a key role in the provision of cervical cancer prevention services. The new simpler technologies (as used in the screen-and-treat approach) offer opportunities for task shifting within the team of health-care providers.

Some possible roles for providers at different levels of the health-care system are as follows:

- Community health workers (CHWs) may be involved in raising awareness about cervical cancer in the community, motivating and assisting women to use services, and following up with those who have received a positive screening test result and those who have been treated at higher levels of care when they return home.
- Primary care providers can promote services and conduct screening, follow-up and counselling, and can refer their patients to higher-level facilities as necessary, including provision of clear information about what to expect at those facilities.
- Secondary care (district-level) providers perform a range of diagnostic and treatment services, and refer patients to both higher and lower levels of care. As outlined above, these providers may also be charged with programme considerations.
- Tertiary care providers manage patients with invasive and advanced disease, and refer them back to lower (primary and secondary) levels of care, when appropriate.

Using the guide

As with the first edition, this revised guide provides broadly applicable information that can be adapted to local health systems as well as to local needs, language and culture.

This guide and its recommendations can be used at the national level as a basis for developing or adapting national guidelines, for modifying policies and practices, and/or for updating programmes, so that they are clearly in line with WHO's internationally recognized evidence-based standards.

This guide can be used by health-care providers and programme managers at all levels of the health system:

- as a reference manual, providing basic, up-to-date information about prevention, screening, diagnosis and treatment of cervical cancer;
- to design pre-service and in-service education and training, and as a self-education tool;
- as a review of the procedures for prevention and management of cervical cancer;
- to find evidence-based advice on how to handle specific situations;
- to understand how the roles of different providers are linked with each other at the various levels of the health-care system.

It may also be used for the development of human resources for health, as a reference when developing training courses and support materials for community-based and other workers newly involved in cervical cancer services at the local level.

This guide can be used as a whole, or users can focus on the sections that are relevant to their area and level of practice.

Guideline dissemination

These guidelines will be available online at the WHO Library database and there will be a link on WHO's Sexual and Reproductive Health web page and in the *WHO Reproductive Health Library* (RHL), an electronic review journal.¹ The publication will also be announced in the UNDP/UNFPA/UNICEF/WHO/World Bank Special Programme of Research, Development and Research Training in Human Reproduction (HRP) *WHO Reproductive Health Update*,² which reaches more than 2000 subscribers and numerous organizations with whom we are working. Many of these organizations will also copy the announcement in their newsletters.

The guidelines will be distributed in print to subscribers to WHO publications, to the WHO mailing list for mandatory free distribution (national chief health executives, ministers of health or directors-general of health, depository libraries for WHO publications, WHO representatives/liaison officers, WHO/HQ library, WHO regional offices, and off-site office libraries), additional non-mandatory free recipients (competent national authorities for sexual and reproductive health, cancer control programmes, national research centres in reproductive health, and WHO collaborating centres), WHO staff at headquarters, regional and country offices and elsewhere, concerned NGOs, medical societies concerned with cancer control and/or sexual and reproductive health, scientific journals (including general medical journals and journals specialized on sexual and reproductive health or cancer), international organizations, and donors, potential donors, potential publishers of translated versions, as well as all those who contributed to the documents,³ and the International Federation of Gynecology and Obstetrics (FIGO) World Congress,⁴ among others. A number of webinars are also planned in 2015 and 2016 in each of the WHO regions with the Cervical Cancer Action group.⁵

¹ The WHO Library database is available at <http://www.who.int/library/databases/en/>; WHO's Sexual and Reproductive Health web page is available at <http://www.who.int/reproductivehealth/topics/cancers>; WHO's RHL is available at: <http://apps.who.int/rhl/en/>.

² A subscription to HRP's WHO Reproductive Health Update can be requested at <http://www.who.int/reproductivehealth/RHUpdate/en/>.

³ See: <http://www.uicc.org/convening/world-cancer-congress>

⁴ See: <http://figo2015.org/>

⁵ See: <http://www.cervicalcanceraction.org/home/home.php>

Regional workshops are already planned in the Americas and Africa to present the new WHO guidelines to a number of stakeholders involved in national programme planning in 2015. The other regions will be covered in 2016–2017.

If requested by WHO regional offices, countries will be supported to adapt the guideline to their country-specific needs and to integrate the material with existing national guidelines. Adaptation will be done by organizing regional, sub-regional and country-level workshops for discussion of the key elements of the guidelines, in order to adapt them to the national epidemiologic, cultural and socioeconomic context. Initially, the guidelines will be available in English only and translations will be developed subject to the availability of funding. Translation into non-UN languages and publication in these languages by third parties will be encouraged.

Guideline evaluation

The number of downloads from the WHO web sites (headquarters and regional) will be used as an indicator of interest in these guidelines.

At WHO headquarters, Department of Reproductive Health and Research, we are working with the WHO regional offices to monitor requests from countries for technical assistance to use these guidelines. For this purpose, national stakeholder meetings will be organized in-country, and feedback on the clarity, feasibility and usefulness of the recommendations and guidelines will be recorded. We will also monitor, with the regional offices, how many countries change their national guidelines based on the publication of these new WHO guidelines.

Guideline update

The Guideline Development Group will continue to work with WHO in an ad hoc manner for each of the chapters, so that the research gaps identified during the process can be addressed. In addition, evidence published on new cervical cancer and pre-cancer screening and treatment methods will be monitored so that updates to the guidance and recommendations can be promptly considered. The same will apply to the recommendations relating to HPV vaccination, with the Strategic Advisory Group of Experts (SAGE) on Immunization constantly reviewing relevant new published data. A group at WHO's Cancer Control Programme will also work on the recommendations for the treatment of cancer in general. Finally, following the 2014 World Health Assembly resolution on palliative care, a group will also develop new recommendations on this subject. At WHO, we anticipate that approximately five years after the publication of these recommendations sufficient new evidence will be available to update the present WHO guidelines and potentially add new ones.

In the community



At the health centre



At the district hospital



At the central hospital



Levels of the health-care system⁶

Community Level

This level includes individuals and organizations; community-based, faith-based and other nongovernmental organizations; and community and home-based palliative care services. Also included are health posts, which are usually staffed by an auxiliary nurse or community health worker.

Health Centre – Primary Care Level

A health centre is a primary care facility with trained staff and regular working hours. Maternity and minimal laboratory services may be available.

Providers at this level include nurses, auxiliary nurses or nursing assistants, counsellors, health educators, medical assistants, clinical officers and, sometimes, physicians.

District Hospital – Secondary Care Level

Typically, a hospital at this level provides general medical, paediatric and maternity services, general surgery, inpatient and outpatient care, and specialized care in some specific areas. Patients may be referred to this level from health centres and private practitioners in the district. Laboratory services may include cytology and histopathology.

Providers include generalist physicians or clinical officers, nurses, pharmacy technicians or dispensing clerks, medical assistants, nurse assistants and laboratory technology assistants, and possibly a gynaecologist and a cytotechnologist. Private and mission hospitals are often present at this level.

Central Or Referral Hospital – Tertiary Care Level

Tertiary care hospitals provide specialized care for complex cases and acutely ill patients, including surgery, radiotherapy and multiple outpatient and inpatient services. General medical, acute and chronic care clinics are offered. The most complete public-sector diagnostic and reference laboratory services are available with pathologists and cytotechnologists, radiology and diagnostic imaging. Providers may include gynaecologists, oncologists and radiotherapists, as well as those present at lower levels of care.

⁶ This description does not include services and providers outside the formal health system, such as traditional healers, traditional birth attendants, medicine sellers and others, who also play important roles.

Essential reading

- Alliance for Cervical Cancer Prevention (ACCP). Planning and implementing cervical cancer prevention and control programs: a manual for managers. Seattle (WA): ACCP; 2004 (<http://whqlibdoc.who.int/paho/2004/a92126.pdf>, accessed 18 July 2014).
- International Agency for Research on Cancer (IARC). IARC handbooks of cancer prevention, volume 10: cervix cancer screening. Lyon: IARC; 2005 (<http://www.iarc.fr/en/publications/pdfs-online/prev/handbook10/index.php>, accessed 18 July 2014).
- World Health Organization (WHO). Cancer pain relief: with a guide to opioid availability, 2nd edition. Geneva: WHO; 1996 (<http://whqlibdoc.who.int/publications/9241544821.pdf>, accessed 21 November 2014).
- World Health Organization (WHO). Cervical cancer screening in developing countries: report of a WHO consultation. Geneva: WHO; 2002 (<http://whqlibdoc.who.int/publications/2002/9241545720.pdf>, accessed 21 November 2014).
- World Health Organization (WHO). Surgical care at the district hospital. Geneva: WHO; 2003 (<http://www.who.int/surgery/publications/en/SCDH.pdf>, accessed 18 July 2014).
- World Health Organization (WHO). Resolution WHA58.22. Cancer prevention and control. Fifty-eighth World Health Assembly, Geneva, 16–25 May 2005. Geneva: WHO; 2005 (http://www.who.int/ipcs/publications/wha/cancer_resolution.pdf, accessed 18 July 2014).
- World Health Organization (WHO). Cancer control knowledge into action: WHO guide for effective programmes: palliative care (module 5). Geneva: WHO; 2007 (http://www.who.int/cancer/publications/cancer_control_palliative/en/, accessed 21 November 2014).
- World Health Organization (WHO). Cervical cancer, human papillomavirus (HPV), and HPV vaccines: key points for policy-makers and health professionals. Geneva: WHO; 2007 (http://whqlibdoc.who.int/hq/2008/WHO_RHR_08.14_eng.pdf, accessed 21 November 2014).
- World Health Organization (WHO). Everybody's business: strengthening health systems to improve health outcomes: WHO's framework for action. Geneva: WHO; 2007 (http://www.who.int/healthsystems/strategy/everybodys_business.pdf, accessed 21 November 2014).
- World Health Organization (WHO). Cancer control knowledge into action: WHO guide for effective programmes: diagnosis and treatment (module 4). Geneva: WHO; 2008 (http://www.who.int/cancer/publications/cancer_control_diagnosis/en/, accessed 21 November 2014).

- World Health Organization (WHO). A strategic approach to strengthening control of reproductive tract and sexually transmitted infections: use of the programme guidance tool. Geneva: WHO; 2009 (<http://www.who.int/reproductivehealth/publications/rtis/9789241598569/en/>, accessed 21 November 2014).
- World Health Organization (WHO). New vaccine post-introduction evaluation (PIE) tool. Geneva: WHO; 2010 (http://www.who.int/immunization/monitoring_surveillance/resources/PIE_tool/en/, accessed 21 November 2014).
- World Health Organization (WHO). WHO guidelines: use of cryotherapy for cervical intraepithelial neoplasia. Geneva: WHO; 2011 (<http://www.who.int/reproductivehealth/publications/cancers/9789241502856/en/>, accessed 18 July 2014).
- World Health Organization (WHO). Cervical cancer prevention and control costing tool (C4P): user's guide. Geneva: WHO; 2012 (http://www.who.int/immunization/diseases/hpv/cervical_cancer_costing_tool/en/, accessed 21 November 2014).
- World Health Organization (WHO). WHO guidelines for the pharmacological treatment of persisting pain in children with medical illness. Geneva: WHO; 2012 (http://whqlibdoc.who.int/publications/2012/9789241548120_Guidelines.pdf, accessed 21 November 2014).
- World Health Organization (WHO). WHO information sheet: observed rate of vaccine reactions: human papillomavirus vaccine. Geneva: WHO; 2012 (http://www.who.int/vaccine_safety/initiative/tools/HPV_Vaccine_rates_information_sheet.pdf, accessed 21 November 2014).
- World Health Organization (WHO). WHO technical specifications: cryosurgical equipment for the treatment of precancerous cervical lesions and prevention of cervical cancer. Geneva: WHO; 2012 (<http://www.who.int/reproductivehealth/publications/cancers/9789241504560/en/>, accessed 18 July 2014).
- World Health Organization (WHO). Global action plan for the prevention and control of NCDs 2013–2020. Geneva: WHO; 2013 (<http://www.who.int/nmh/publications/ncd-action-plan/en/>, accessed 21 November 2014).
- World Health Organization (WHO). WHO guidance note: comprehensive cervical cancer prevention and control: a healthier future for girls and women. Geneva: WHO; 2013 (<http://www.who.int/reproductivehealth/publications/cancers/9789241505147/en/>, accessed 18 July 2014).
- World Health Organization (WHO). WHO guidelines for screening and treatment of precancerous lesions for cervical cancer prevention. Geneva: WHO; 2013 (http://www.who.int/reproductivehealth/publications/cancers/screening_and_treatment_of_precancerous_lesions/en/, accessed 18 July 2014).

- World Health Organization (WHO). Human papillomavirus vaccines: WHO position paper, October 2014. *Wkly Epidemiol Rec.* 2014; 89(43):465–92 (<http://www.who.int/wer/2014/wer8943.pdf>, accessed 21 November 2014).
- World Health Organization (WHO). Implementation tools: package of essential noncommunicable (PEN) disease interventions for primary health care in low-resource settings. Geneva: WHO; 2014 (<http://www.who.int/nmh/ncd-tools/en/>, accessed 18 July 2014).
- World Health Organization (WHO). Meeting of the Strategic Advisory Group of Experts on immunization, April 2014 – conclusions and recommendations. *Wkly Epidemiol Rec.* 2014;89(21):221–36 (<http://www.who.int/wer/2014/wer8921.pdf>, accessed 21 November 2014).
- World Health Organization (WHO). Principles and considerations for adding a vaccine to a national immunization programme: from decision to implementation and monitoring. Geneva: WHO; 2014 (http://www.who.int/immunization/programmes_systems/policies_strategies/vaccine_intro_resources/nvi_guidelines/en/, accessed 21 November 2014).
- World Health Organization (WHO). Resolution WHA 67.19. Strengthening of palliative care as a component of integrated treatment throughout the life course. Sixty-seventh World Health Assembly, agenda item 15.5, Geneva, 24 May 2014. Geneva: WHO; 2014 (WHA 67.19; http://apps.who.int/gb/ebwha/pdf_files/WHA67/A67_R19-en.pdf, accessed 18 July 2014).
- World Health Organization (WHO). WHO guidelines for treatment of cervical intraepithelial neoplasia 2–3 and adenocarcinoma in situ: cryotherapy, large loop excision of the transformation zone, and cold knife conization. Geneva: WHO; 2014 (http://apps.who.int/iris/bitstream/10665/104174/1/9789241506779_eng.pdf, accessed 18 July 2014).
- World Health Organization (WHO), International Agency for Research on Cancer (IARC), African Population and Health Research Center (APHRC). Prevention of cervical cancer through screening using visual inspection with acetic acid (VIA) and treatment with cryotherapy: a demonstration project in six African countries: Malawi, Madagascar, Nigeria, Uganda, the United Republic of Tanzania, and Zambia. Geneva: WHO; 2012 (http://apps.who.int/iris/bitstream/10665/75250/1/9789241503860_eng.pdf, accessed 18 July 2014).
- World Health Organization (WHO), Pan American Health Organization (PAHO). Monitoring national cervical cancer prevention and control programmes: quality control and quality assurance for visual inspection with acetic acid (VIA)-based programmes. Geneva: WHO; 2013 (<http://www.who.int/reproductivehealth/publications/cancers/9789241505260/en/>, accessed 18 July 2014).

World Health Organization (WHO), United Nations Children's Fund (UNICEF). The WHO–UNICEF joint statement: vaccine donations, August 7, 2010. Geneva: WHO; 2010 (http://whqlibdoc.who.int/hq/2010/WHO_IVB_10.09_eng.pdf, accessed 21 November 2014).

World Health Organization (WHO), United Nations Children's Fund (UNICEF). WHO–UNICEF guidelines for developing a comprehensive MultiYear Plan (cMYP). Geneva: WHO; 2014 (http://www.who.int/immunization/documents/control/WHO_IVB_14.01/en/, accessed 21 November 2014).

Useful websites:

Alliance for Cervical Cancer Prevention (ACCP): www.alliance-cxca.org

EngenderHealth: www.engenderhealth.org

Grounds for Health: www.groundsforhealth.org

International Agency for Research on Cancer (IARC): www.iarc.fr

Jhpiego: www.Jhpiego.org

PATH: www.path.org

WHO Department of Reproductive Health and Research:

www.who.int/reproductivehealth

WHO Department of Immunization, Vaccines and Biologicals:

www.who.int/immunization

WHO Department of Maternal, Newborn, Child and Adolescent Health:

www.who.int/maternal_child_adolescent

WHO Department of Management of Noncommunicable Diseases:

www.who.int/nmh/

WHO Department of Essential Medicines and Health Products:

www.who.int/medicines

WHO HPV Vaccine Introduction Clearing House: www.who.int/immunization/hpv

WHO Human papillomavirus (HPV): www.who.int/immunization/diseases/hpv

1

CHAPTER 1. BACKGROUND

Chapter 1. Background

Key points

- Cervical cancer is a largely preventable disease, but worldwide it is one of the leading causes of cancer death in women. Most deaths occur in low- to middle-income countries.
- The primary cause of cervical pre-cancer and cancer is persistent or chronic infection with one or more of the “high-risk” (or oncogenic) types of human papillomavirus (HPV).
- HPV is the most common infection acquired during sexual relations, usually early in sexual life.
- In most women and men who become infected with HPV, these infections will resolve spontaneously.
- A minority of HPV infections persist; in women this may lead to cervical pre-cancer, which, if not treated, may progress to cancer 10 to 20 years later.
- Women living with HIV are more likely to develop persistent HPV infections at an earlier age and to develop cancer sooner.
- Basic knowledge of women’s pelvic anatomy and the natural history of cervical cancer gives health-care providers at primary and secondary levels the knowledge base to effectively communicate and raise the understanding of cervical cancer prevention in women, families and communities.

About this chapter

This chapter is based on the following WHO guidelines:

Cervical cancer screening in developing countries: report of a WHO consultation.

Geneva: WHO; 2002 (<http://whqlibdoc.who.int/publications/2002/9241545720.pdf>).

WHO guidance note: comprehensive cervical cancer prevention and control: a

healthier future for girls and women. Geneva: WHO; 2013 (http://apps.who.int/iris/bitstream/10665/78128/3/9789241505147_eng.pdf).

Other articles and publications on which the chapter is based can be found under Further reading, at the end of the chapter.

This chapter has three sections. Section 1.1, Why focus on cervical cancer?, summarizes global statistics and the large disparities within and between countries in the rates of new cases diagnosed (incidence) and deaths recorded (mortality) each year. This information illustrates the burden that cervical cancer places on women and on health services, and the reasons why universal access to preventive services is of the utmost importance.

Section 1.2, Female pelvic anatomy and physiology, illustrates women's pelvic anatomy and describes the changes to the cervix that take place across the lifespan, from infancy to postmenopause. It also explains how these changes relate to cervical cancer prevention. Basic knowledge of women's reproductive anatomy gives health-care providers helpful tools for communicating with women, families and communities about cervical cancer prevention services (see Chapter 3).

Section 1.3, Natural history of cancer of the cervix, provides information on the very slow progression of changes caused by persistent HPV infection. Health-care providers need to understand these sequential changes to be able to explain to the community why we have the opportunity to prevent most cervical cancer from occurring, and thus avoid the suffering and premature deaths that it causes.

1.1 Why focus on cervical cancer?

1.1.1 Reasons to focus on cervical cancer

The reasons to focus on cervical cancer include:

- Worldwide, 266 000 women die of cervical cancer each year. It is the leading cause of cancer deaths in Eastern and Central Africa.
- The majority of these deaths can be prevented through universal access to comprehensive cervical cancer prevention and control programmes, which have the potential to reach all girls with human papillomavirus (HPV) vaccination and all women who are at risk with screening and treatment for pre-cancer.
- We know what causes cervical cancer: almost all cases are caused by a persistent (very long-lasting) infection with one or more of the “high-risk” (or oncogenic) types of HPV.
- We understand the natural history of HPV infection and the very slow progression of the disease in immunocompetent women, from normal (healthy) to pre-cancer, to invasive cancer, which is potentially fatal.
- The 10- to 20-year lag between pre-cancer and cancer offers ample opportunity to screen, detect and treat pre-cancer and avoid its progression to cancer. However, immunocompromised women (e.g. those living with HIV) progress more frequently and more quickly to pre-cancer and cancer.
- There are several available and affordable tests that can effectively detect pre-cancer, as well as several affordable treatment options.
- HPV vaccines are now available; if given to all girls before they are sexually active, they can prevent a large portion of cervical cancer.
- Until there is universal access to cervical cancer prevention and control programmes, which will require addressing present inequities, the large disparities in incidence rates and mortality rates that exist in different settings will continue to be ample evidence of lack of comprehensive and effective services.

1.1.2 Global epidemiology of cervical cancer

Epidemiology is the study of the distribution and determinants of health-related states or events (including disease), and the application of this study to the control of diseases and other health problems.

a. Numbers and comparisons between countries

Cervical cancer is the most common cancer among women in 45 countries of the world, and it kills more women than any other form of cancer in 55 countries. These include many countries in sub-Saharan Africa, many in Asia (including India), and some Central and South American countries. The maps in Figures 1.1 and 1.2 illustrate global differences in incidence and mortality rates between countries and regions of the world. These maps do not include the wide disparities in incidence and mortality between areas within specific countries, which are related to socioeconomic and geographic variation, gender bias and culturally determined factors that can all severely restrict access to preventive services among some groups of women.

Further, the following data clearly illustrate the great differences found between women living in high-income versus low- to middle-income countries:

- In 2012, 528 000 new cases of cervical cancer were diagnosed worldwide; of these, a large majority, about 85% occurred in less developed regions.
- In the same year, 266 000 women died of cervical cancer worldwide; almost 9 out of every 10 of these, or 231 000 women in total, lived and died in low- to middle-income countries. In contrast, 35 000, or just 1 out of every 10 of these women, lived and died in high-income countries.

The main reason for these disparities is the relative lack of effective prevention and early detection and treatment programmes, and the lack of equal access to such programmes. Without these interventions, cervical cancer is usually only detected when it is already at an advanced stage so that it is too late for effective treatment, and therefore mortality is high.

b. Changes observed in numbers of cases diagnosed and deaths in the last 30 years

Over the last 30 years, cervical cancer incidence and mortality rates have fallen in countries where social and economic status has improved. This is largely a result of the implementation of secondary prevention efforts, which include effective screening, early diagnosis and treatment for pre-cancer and early cancer.

To summarize this section of Chapter 1, the statistics that have been presented here reflect a shocking neglect of women in low- and middle-income countries, making it imperative to establish effective services for all.

Figure 1.1: Estimated cervical cancer incidence worldwide, 2012

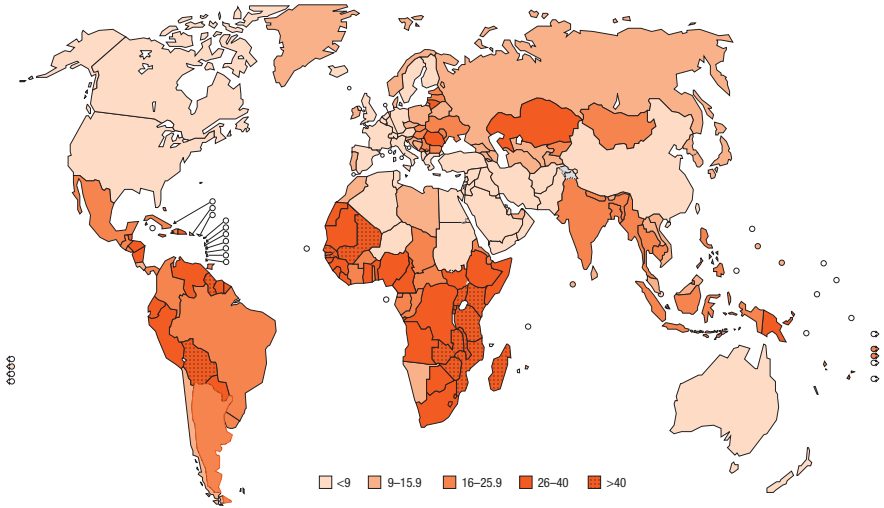

Source: International Agency for Research on Cancer (IARC), World Health Organization (WHO). GLOBOCAN 2012: estimated cancer incidence, mortality and prevalence worldwide in 2012: cancer fact sheets: cervical cancer. Lyon: IARC; 2014.

Figure 1.2: Estimated cervical cancer mortality worldwide, 2012

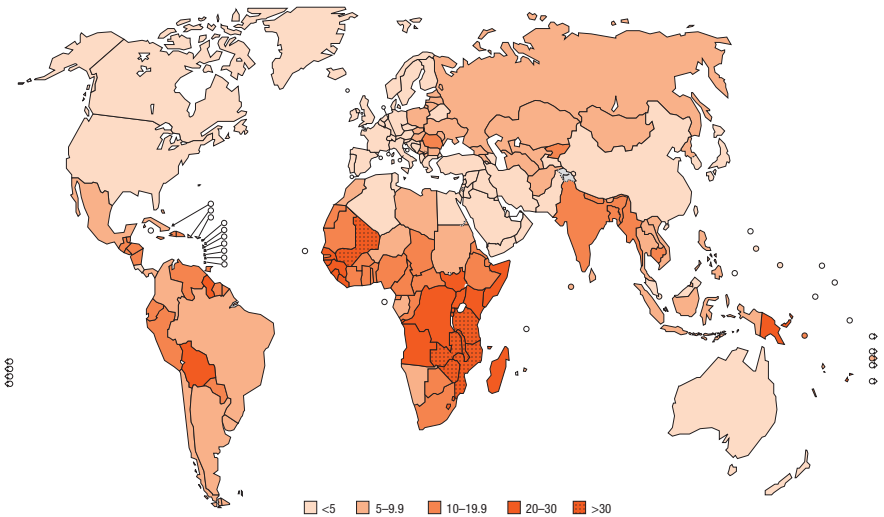

Source: International Agency for Research on Cancer (IARC), World Health Organization (WHO). GLOBOCAN 2012: estimated cancer incidence, mortality and prevalence worldwide in 2012: cancer fact sheets: cervical cancer. Lyon: IARC; 2014.

1.2 Female pelvic anatomy and physiology

1.2.1 Why understanding female genital anatomy is important

An understanding of the anatomy of the female pelvic structures will help health-care providers involved in cervical cancer programmes to:

- perform their tasks, including community education, screening, diagnosis and treatment of pre-cancer;
- refer women who have lesions that cannot be managed at the provider's level to appropriate higher-level facilities;
- interpret laboratory and treatment procedure reports and clinical recommendations received from providers at higher levels of the health-care system;
- educate and provide one-on-one counselling to each patient (and her family if she requests this) about her condition and the plan for her follow-up care; and
- communicate effectively with providers at all levels of care, including community health workers and tertiary-level referral providers.

See Introduction for descriptions of the different levels of health-care services and the providers at each level.

1.2.2 Identification of the external and internal organs

a. The external organs

The external organs include those visible with the naked eye and those visible using a speculum. Figure 1.3 shows the area seen when a woman of reproductive age spreads her legs. This includes the vulva (the area between the upper border in figure and the level of the Bartholin glands), the perineum and the anus. The vulva comprises the vaginal opening (introitus), which, with nearby structures, is protected by the major and minor labia. The clitoris is a small and very sensitive organ that enhances sexual pleasure. The urinary opening (urethra) is a very small opening above the introitus. The perineum is the area between the vaginal opening and the anus. Bartholin glands produce clear mucus which lubricate the introitus when a woman is sexually stimulated.

Figure 1.3: Female external genitalia

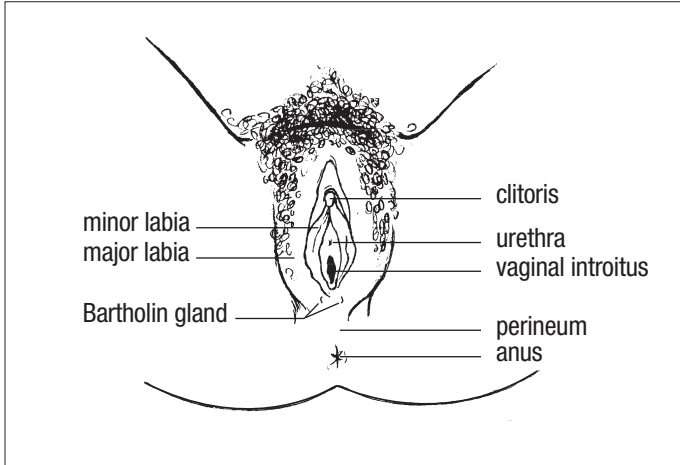

b. The internal organs

The organs inside the pelvis are not visible except when exposed by an incision or laparoscopy. As shown in Figure 1.4, the urinary bladder and urethra are behind the pubic bone and in front of the vagina and cervix. The body of the uterus is above the cervix and the bottom of the colon and rectum are behind the genital structures. The uterus is held in place by thickenings or ligaments in the lining of the abdomen (peritoneum). The ureters (thin tubes that carry urine from the kidneys to the bladder) are on either side of the uterus but are not shown in these figures.

Figure 1.4: Front and side views of female internal organs

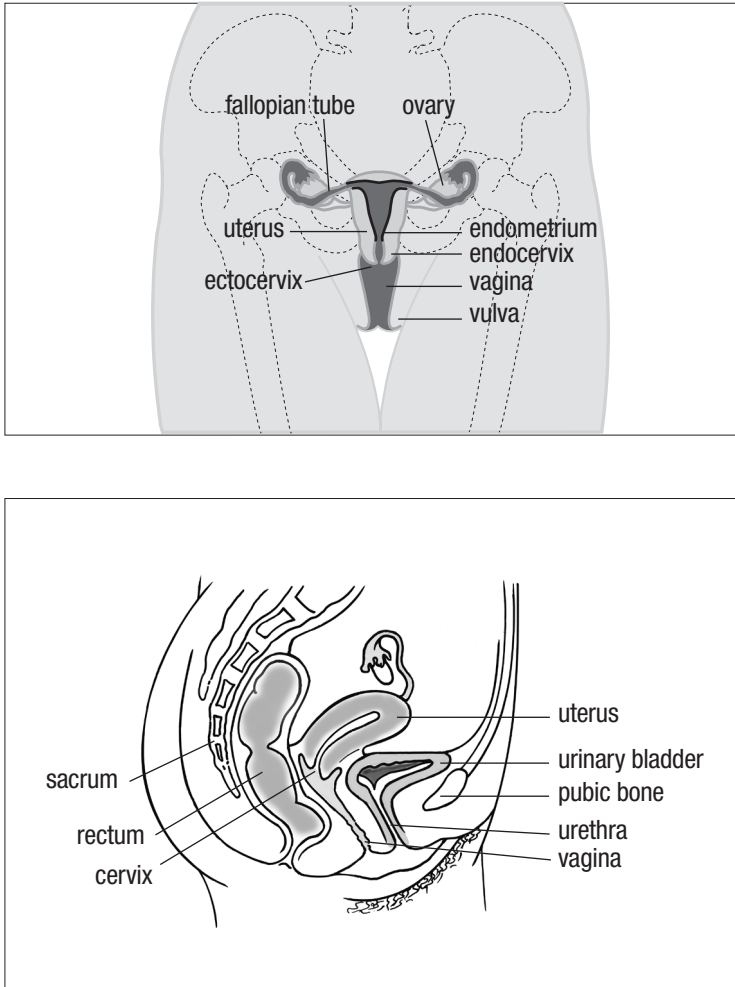

1.2.3 Brief description of the pelvic organs

a. Vagina

The vagina is an elastic muscular tube with multiple folds, leading from the introitus to the cervix. The lower portion of the cervix (ectocervix) protrudes into the upper end of the vagina and the vaginal area surrounding it is called the vaginal fornix.

b. Cervix

The cervix is the lower third of the uterus. In a non-pregnant woman of fertile age, it measures approximately 3 cm in length and 2.5 cm in diameter. The lower part of the cervix (ectocervix) lies within the vagina and is visible with a speculum; the upper two thirds of the cervix (endocervix) lies above the vagina and is not visible. Most cervical cancers originate in the area where the endocervix and ectocervix join. Figure 1.5 shows the uterus and the relative size of the cervix as part of the uterus in a woman of reproductive age.

Figure 1.5: Uterus and cervix of a woman of reproductive age

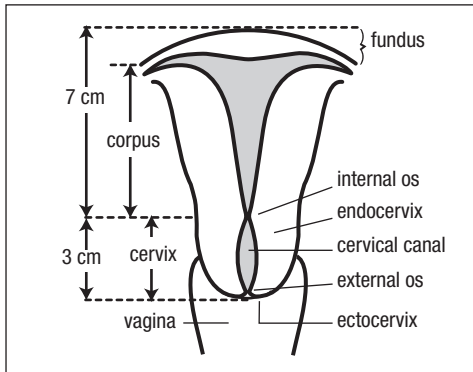

The cervix is composed of dense fibro-muscular tissue. The cervical canal runs through the centre of the cervix from the internal os (the opening at the entrance to the cavity of the uterus) to the external os (the opening in the cervix seen with a speculum).

Figure 1.6 is a slightly enlarged photograph of the cervix as seen with a speculum in place. It shows the slightly irregular opening to the cervical canal, or external os, in a woman of reproductive age who has not had any vaginal deliveries. In a woman who has had one or more deliveries, the os would look like a wide, mouth-like, irregular slit. In this figure, the darker area surrounding the os is an extension of the columnar epithelium lining the canal; the lighter area around it is composed of stratified squamous epithelium extending from the vagina. The line where the two epithelia join is the squamocolumnar junction (SCJ).

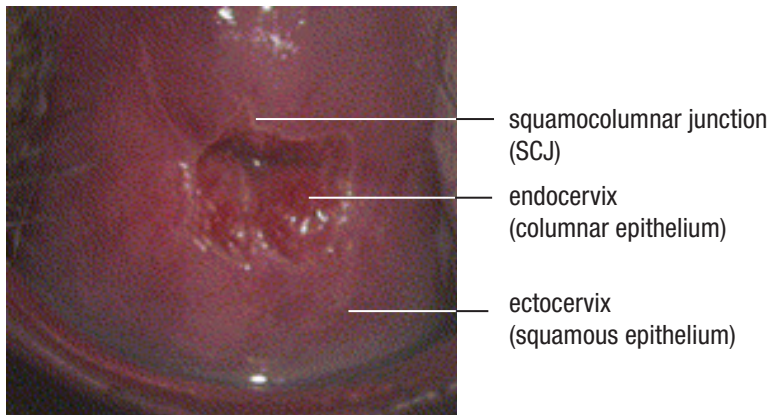
Figure 1.6: Cervix

Please see later sections for a more detailed description of the cervical epithelia and normal changes that occur during the reproductive years (section 1.2.4), and for a description of the changes in the appearance of the cervix across a woman's lifespan (section 1.2.5). Those sections serve as an important preamble to section 1.3: Natural history of cancer of the cervix.

c. Uterus

The uterus or womb is a thick-walled, pear-shaped, hollow, muscular organ. When not enlarged by pregnancy or a tumour, the uterus measures approximately 10 cm from its top (fundus) to the bottom of the ectocervix (see Figure 1.5). It is supported by several ligaments formed by thickenings of the peritoneum (the very thin membrane lining of the abdominal wall), which are attached to the pelvic wall. The area between the uterus and the pelvic wall is the parametrium.

The cavity of the uterus is lined by the endometrium, a layer of epithelium that contains many glands; the endometrium undergoes dramatic changes during the menstrual cycle and during pregnancy.

d. Ovaries

The ovaries are paired organs on either side of the pelvis. With few exceptions, in a woman who is having natural monthly periods, an egg is produced by either one of the ovaries (ovulation) every month.

e. Fallopian tubes

The fallopian tubes are thin hollow tubes and are the route used by the egg to travel from the ovary to the uterus. It is in the fallopian tube that fertilization of the egg takes place if the woman has intercourse in the days immediately before and/or after ovulation without contraception.

f. Blood and lymphatic structures in the pelvis

The arteries and veins that supply the uterus and cervix descend on both sides along the length of the cervix. It is important to keep the vessel location in mind to avoid injecting local anaesthetic into a vessel when applying cervical anaesthesia.

The lymph nodes and ducts draining the pelvic organs lie close to the blood vessels and may act as a pathway for the spread of cervical cancer. In late stages of cancer, large tumours may block lymphatic drainage and cause the legs to swell (lymphoedema).

g. Nervous system of the pelvic region

The ectocervix has no pain nerve endings; thus, procedures involving only this area (e.g. biopsy and cryotherapy) are well tolerated without anaesthesia. In contrast, the endocervix has many sensory nerve endings that will cause a woman to feel pain during procedures involving this area (e.g. endocervical curettage, injury and stretching).

Networks of nerves are also present within the cervix; these nerves are part of the autonomic nervous system, which is involved in the control of the heart rate, blood pressure and other bodily functions. Procedures involving the endocervical canal, such as insertion of an endocervical speculum or curette, may stimulate these nerves and cause a vasovagal reaction, characterized by sweating, slow heart rate, low blood pressure and fainting.

A paracervical block, to produce local anaesthesia for certain procedures, is performed by injecting anaesthetic at various points in the body of the ectocervix or the vaginal fornices, but avoiding inserting the needle at 3 and 9 o'clock, where vessels are present.

1.2.4 The cervical epithelia and normal changes during the reproductive years

a. Description of the cervical epithelia

The surface of the cervix is lined by two types of epithelium, which is the lining that is found on skin and inside hollow organs. The ectocervix is covered by the strong, protective, stratified (multi-layered) squamous epithelium, which is a continuation of the vaginal covering. The canal is covered by a single layer of tall columnar cells – the columnar epithelium – which lines the cervical canal (see Figures 1.7 and 1.8).

Figure 1.7: The normal cervix

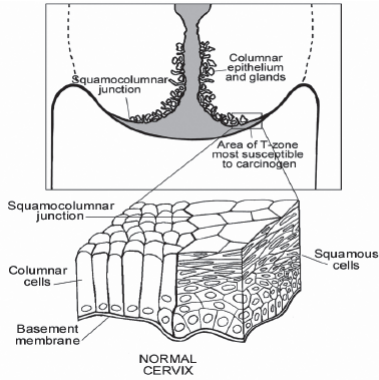

Source: Blumenthal PD, McIntosh N. Cervical cancer prevention guidelines for low-resource settings. Baltimore (MD): Jhpiego; 2005.

Figure 1.8: The two types of cervical epithelium and the squamocolumnar junction (SCJ)

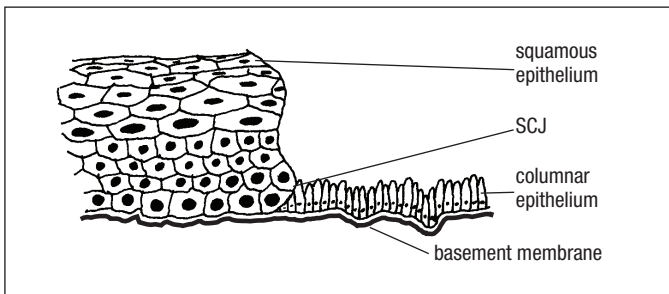

Source: Adapted with permission from Sellors JW, Sankaranarayanan R. Colposcopy and treatment of cervical intraepithelial neoplasia: a beginners' manual. Lyon: International Agency for Research on Cancer; 2003.

The stratified squamous epithelium, as shown in Figure 1.8, consists of a plump, deep layer topped by multiple layers of increasingly tile-like, flatter cells.

The columnar epithelium, a single layer of tall cells, lines the cervical canal and extends outwards to a variable portion of the ectocervix. It is much thinner and more fragile than the squamous epithelium of the ectocervix and contains multiple glands that lubricate the canal.

The squamocolumnar junction (SCJ) is where the two types of epithelia meet. The SCJ is seen in Figure 1.8 as a sharp line with a step caused by the different thicknesses of the two epithelia. The location of the SCJ varies with a woman's age, hormonal status, history of birth trauma, pregnancy status and use of oral contraceptives.

b. Normal changes in the cervical epithelia during a woman's reproductive years

When exposed to the acidic environment of the vagina, the more fragile columnar epithelium that extends out from the cervical canal onto the face of the cervix is replaced by more sturdy squamous epithelium. This normal replacement process is termed squamous metaplasia; it gives rise to a second SCJ. The area of variable size between the original and the new SCJs is the transformation zone.

As we will describe in the next section of this chapter, on the natural history of cancer of the cervix (section 1.3), the cells of the transformation zone are particularly vulnerable to HPV infection and it is here that most squamous cell carcinoma develops.

Figure 1.9: The transformation zone of the cervix of a parous woman of reproductive age

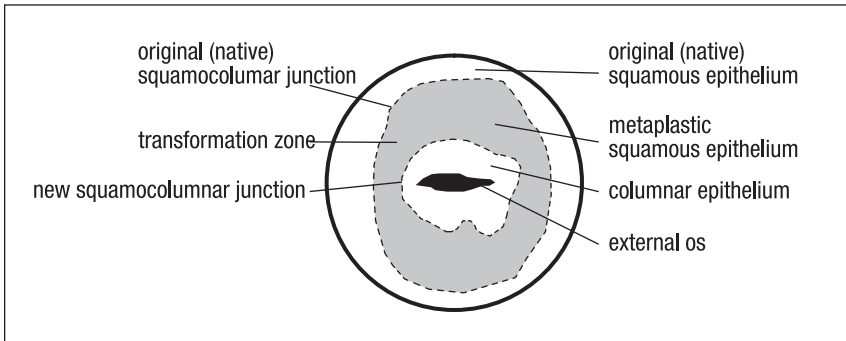

Source: Reproduced with permission from Sellors JW, Sankaranarayanan R. Colposcopy and treatment of cervical intraepithelial neoplasia: a beginners' manual. Lyon: International Agency for Research on Cancer; 2003.

Figure 1.9 depicts the face of the cervix of a woman who has had one or more vaginal births. It shows the normal changes that now include the squamous metaplastic epithelium, the transformation zone and both SCJs.

1.2.5 Normal changes in the appearance of the cervix as a woman ages

In addition to the epithelial changes on the cervix described in section 1.2.4, the appearance of the cervix also undergoes striking changes from birth to postmenopause. Figure 1.10 is composed of schematic drawings showing these age-induced changes in the cervix, although it should be noted that in real life the appearance and demarcation of a woman's cervix at different life-stages is not quite as neat as shown.

Figure 1.10: Appearance of the cervix across a woman's lifespan

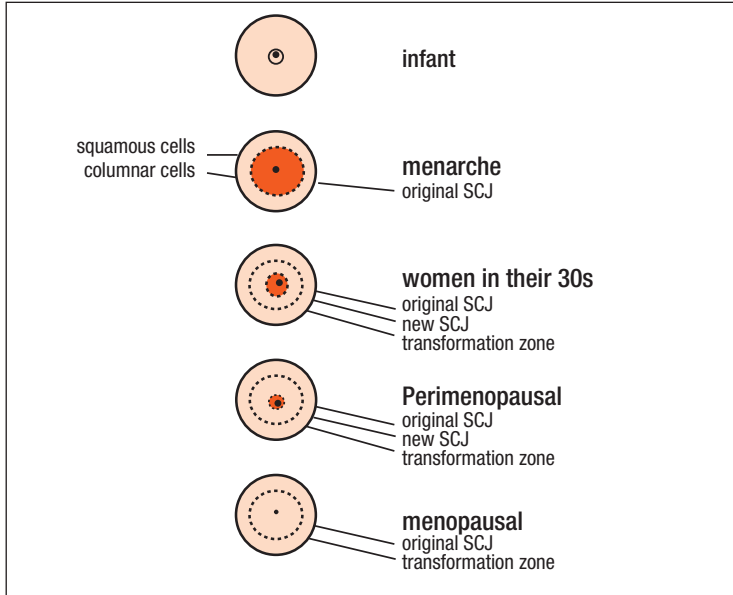

SCJ: squamocolumnar junction.

Source: Drawing by August Burns; adapted with permission from Sellors JW, Sankaranarayanan R. Colposcopy and treatment of cervical intraepithelial neoplasia: a beginners' manual. Lyon: International Agency for Research on Cancer; 2003.

a. From birth to prepuberty

The original SCJ is present in girls at birth, and is found at or near the external os.

b. From menarche to early reproductive age

At puberty when the ovaries begin to secrete estrogen, the cervix grows in size; columnar cells from the endocervix and the original SCJ become visible on the ectocervix.

c. In women in their 30s

Under the influence of estrogen, the normal maturing process or squamous metaplasia has occurred and the original and new SCJs are both in place. The transformation zone is the area between the two SCJs.

d. In perimenopausal women

As women age and the influence of estrogen decreases around the time of menopause, the cervix shrinks, and the columnar epithelium and transformation zone retreat back from the ectocervix into the cervical canal.

e. In postmenopausal women

Without estrogen stimulation, the original SCJ is still visible on speculum examination, but the new SCJ and a variable portion of the metaplastic epithelium of the transformation zone have retreated into the cervical canal.

Progressive changes may be uneven, however, and in some postmenopausal women, their cervix may look like the previous figure (perimenopausal), with the new SCJ still partly or completely visible.

1.3 Natural history of cancer of the cervix

1.3.1 What is cancer?

Cancer is a term used for the malignant, autonomous and uncontrolled growth of cells and tissues. Such growth forms tumours, which may invade the tissues around the cancer and cause new growths similar to the original cancer in distant parts of the body, called metastases. As cancer grows, it destroys normal tissues and competes for nutrients and oxygen.

1.3.2 What is cervical cancer?

Persistent infection with cancer-causing HPV types is the cause of most cervical cancer. Ninety per cent of cervical cancers are squamous cell cancers and initiate in the transformation zone of the ectocervix; the other 10% are adenocarcinomas, which arise in the glandular columnar layer of the endocervix.

As stated in section 1.1 of this chapter, cervical cancer is preventable by vaccinating young girls against the human papillomaviruses that cause it and by screening for and treating precancerous lesions in women, since these lesions precede cancer by many years. In addition, if detected early and treated, cervical cancer can still be cured.

1.3.3 What is cervical pre-cancer?

Cervical pre-cancer is a distinct change in the epithelial cells of the transformation zone of the cervix; the cells begin developing in an abnormal fashion in the presence of persistent or long-term HPV infection.

With the majority of cancers, even if they have a precursor stage, it is too short to be noticed and not amenable to easy diagnosis and treatment. Cervical cancer is one of the very few cancers where a precursor stage (pre-cancer) lasts many years before becoming invasive cancer, providing ample opportunity for detection and treatment.

Unfortunately, although preventable, there are still large numbers of women who die of cervical cancer in many countries (see section 1.1). This is because they lack access to services for prevention and treatment – a problem that may be caused

by many factors, such as barriers that limit their access to services (e.g. hours of operation, distance, lack of transportation) as well as prevailing cultural and gender barriers. In most cases, though, the overarching cause is poverty.

1.3.4 HPV infection and cofactors that facilitate persistent infections

The primary cause of cervical pre-cancer and squamous cervical cancer is symptom-free, persistent or chronic infection with one or more of the high-risk (cancer-causing or oncogenic) types of HPV. HPV is the most common sexually transmitted infection.

Of the more than 100 numbered types of HPV, most of them are not associated with cervical cancer. Seven out of 10 (70%) of all cervical cancer cases reported throughout the world are caused by only two types of HPV: 16 and 18. Another four high-risk HPV types – 31, 33, 45 and 58 – are less commonly found to be associated with cervical cancer, with particular types being more prevalent than others in certain geographical areas.

Two low-risk types of HPV (6 and 11) do not cause cervical cancer but are the cause of most genital warts or condylomas.

Almost all women and men are infected with HPV shortly after initiating sexual activity. Penetration of the vagina by the penis does not have to occur because the virus can be transmitted by skin-to-skin contact of the genital areas near the penis and vagina.

As in women, HPV infections in men are also commonly without symptoms and most infections are short-lived. Men can develop cancer of the anus; this is most commonly associated with HPV type 16, and is more common in men who have sex with men. As in women, HPV types 6 and 11 cause the majority of male genital warts.

In women, during puberty and pregnancy, the transformation zone on the ectocervix is enlarged. Exposure to HPV at these times may facilitate infection and may explain the associations between squamous cell cervical cancer and early sexual activity, young age at first birth, and a history of multiple pregnancies. Behaviours that can also increase the risk of HPV infection (and thus cervical cancer) include having multiple partners, and having partners with multiple partners.

While infection with a high-risk HPV type is the underlying cause of almost all cases of cervical cancer, it is NOT the case that these infections almost always cause cancer. In fact, most women infected with high-risk HPV do not develop cancer because most infections, regardless of HPV type, are short-lived; the body eliminates them spontaneously in less than two years. Infection with high-risk HPV only persists (becomes chronic) in a small percentage of women, and only a small percentage of these chronic infections can progress to pre-cancer; of these, even fewer will

progress to invasive cancer. Thus, it is estimated that no more than 2% of all women in low-resource countries will develop cervical cancer during their lifetimes.

The conditions (cofactors) that may lead HPV infection to persist and progress to cancer are not well understood, but the following risk factors probably play a role:

- HPV type – its oncogenicity or cancer-causing strength;
- immune status – people who are immunocompromised, such as those living with HIV, are more likely to have persistent HPV infections and a more rapid progression to pre-cancer and cancer;
- coinfection with other sexually transmitted agents, such as those that cause herpes simplex, chlamydia and gonorrhoea;
- parity (number of babies born) and young age at first birth;
- tobacco smoking;
- use of oral contraceptives for over five years.

The last cofactor, use of oral contraceptives (OCs) for over five years, is the weakest. This was studied extensively by a WHO expert group, which concluded that the great benefits conferred by use of a very effective contraceptive method for preventing unplanned and unwanted pregnancies (with consequent prevention of morbidity and mortality associated with these pregnancies) far outweigh the extremely small potential for an increased risk of cervical cancer that may result from OC use. Thus, it is not in the woman's interest to discourage or prevent her from using OCs. All that is needed is for these women, like all other women, to be screened for cervical cancer.

1.3.5 The development of pre-cancer

After entering cervical epithelial cells, high-risk HPV infection interferes with their normal functions, leading to changes characteristic of pre-cancer (also called dysplasia). See Annex 4 for terminology.



Classification systems

Figure 1.11 depicts the timeline of the progression from a normal (uninfected) cervix to HPV-infected cervix to pre-cancer and invasive cancer. Note that changes occur in both directions because a large proportion of HPV-infected cells return to a normal state and a large proportion of cervical pre-cancers do not become cancer.

Figure 1.11: The timeline and natural history of cervical pre-cancer and cancer development

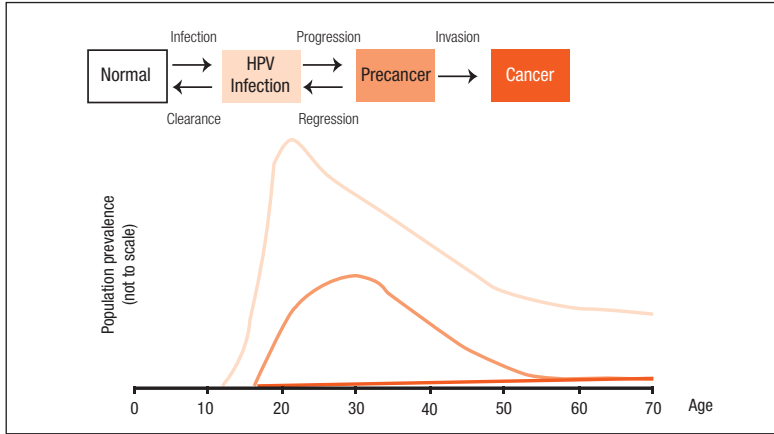

Source: reproduced by permission of the first author from Schiffman M, Wentzensen N, Wacholder S, Kinney W, Gage JC, Castle PE. Human papillomavirus testing in the prevention of cervical cancer. J Natl Cancer Inst 2011;103:368–83.

Figure 1.12 illustrates normal cervical squamous epithelium on the left and progressively thicker layers of new abnormal small cells involving the epithelium in the large intermediate section. As this section in the middle involves more and more of the thickness of the normal epithelium, the epithelium is considered to have mild, then moderate, and finally severe pre-cancer. This sequence leads to invasive cancer if the abnormal cells invade the bottom layer of the epithelium (basement membrane), as shown on the right of the figure.

Figure 1.12: Progress from normal epithelium to invasive cancer

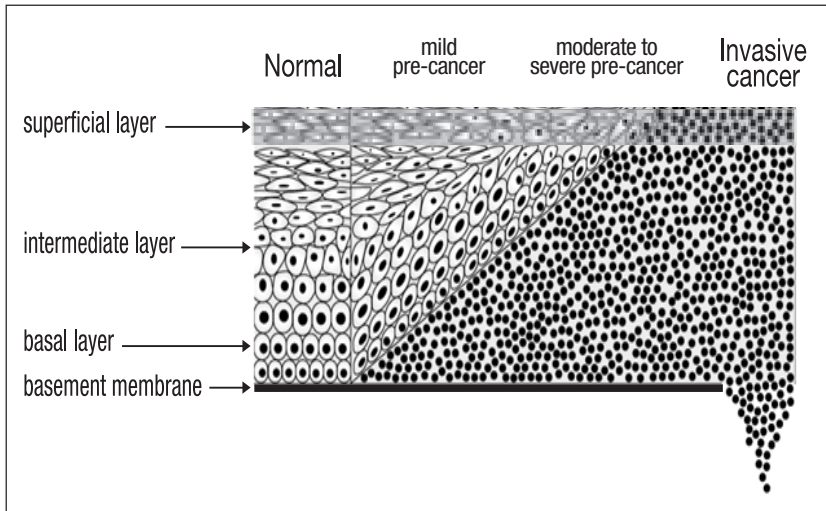

1.3.6 Routes taken by invasive cancer through the body as it progresses

There are four, usually sequential, routes through which invasive cancer progresses.

- i. **Within the cervix:** Spread occurs from a tiny focus of microinvasive cancer until it involves the entire cervix, which can enlarge to 8 cm or more in diameter. The cancer can be ulcerating, exophytic (growing outwards) or infiltrating (invading inwards).
- ii. **To adjacent structures:** Direct spread in all directions is possible – downwards to the vagina, upwards into the uterus, sideways into the tissues supporting the uterus in the pelvis and the ureters, backwards to the rectum, and forwards to the bladder.
- iii. **Lymphatic:** Spread to pelvic lymph nodes occurs in 15% of cases when the cancer is still confined to the cervix, and increases as the cancer spreads. Lymph-node metastases are at first confined to the pelvis and are later found in the chain of nodes along the aorta, eventually reaching the space above the collarbone (supraclavicular fossa). The lymph nodes, once invaded with cancer, are enlarged and, if close to the skin, can be palpated. For example, if the cancer has advanced into the lower third of the vagina, the groin nodes may become involved and will be palpably enlarged, and the supracervical nodes will also feel noticeably enlarged.
- iv. **Distant metastases through the bloodstream and lymph channels.** Cervical cancer cells may spread through the blood stream and lymphatic system to develop distant metastases in the liver, bone, lung and brain.

While invasive cancer initially remains confined within the pelvic area, many cases can still be cured with appropriate treatment. If left untreated, however, cervical cancer progresses in a predictable manner and will almost always lead to death (see Chapter 6 for information on diagnosis and treatment of invasive cervical cancer).

1.3.7 Cervical cancer and human immunodeficiency virus (HIV) infection

Cervical cancer is a defining illness of acquired immunodeficiency syndrome (AIDS)¹ in patients with HIV.

Women living with HIV and other immunocompromised women have a higher prevalence of HPV (the risk of infection increases with the degree of immunosuppression) and a higher prevalence of persistent HPV infection and infection with multiple high-risk HPV types.

¹ According to the United States Centers for Disease Control and Prevention (CDC), a person has AIDS if he or she is HIV-positive and either develops one of a number of AIDS-defining illnesses, including cervical cancer or tuberculosis among others, or is severely immunodepressed (i.e. CD4 lymphocyte count below 200 cells per microlitre) (see CDC, 2008; listed in Further reading at the end of the chapter).

This increased susceptibility to HPV infection leads to:

- a greater risk of pre-cancer and cancer at younger ages, which increases with the degree of immunosuppression;
- an increased risk of developing invasive disease up to 10 years earlier than in women not infected with HIV; and
- more frequent presentation with advanced disease with smaller chance of survival for five years.

The above points strongly suggest the need to develop specific vaccination, screening and treatment protocols for women living with HIV and for all women living in countries or regions with a high prevalence of HIV. Existing protocols are based on experience, and studies are ongoing to determine whether or not these protocols include the best possible practices.

For information specific to women living with HIV, see Chapter 5, sections 5.2.5 and 5.4.6; Chapter 6, section 6.6.2; and Annex 9.



Screen & treat
strategies HIV+

Further reading

- Basu P, Roychowdhury S, Das Bafna U, Chaudhury S, Kothari S, Sekhon R, et al. Human papillomavirus genotype distribution in cervical cancer in India: results from a multi-center study. *Asian Pac J Cancer Prev*. 2009;10(1):27–34.
- Berek JS. Berek & Novak's gynecology, 15th edition. Baltimore (MD): Lippincott Williams & Wilkins; 2011.
- Bhatla N, Lal N, Bao Y-P, Ng T, Qiao Y-L, A meta-analysis of human papillomavirus type-distribution in women from South Asia: implications for vaccination. *Vaccine*. 2008;26:2811–7. doi:10.1016/j.vaccine.2008.03.047.
- Blumenthal PD, McIntosh N. Cervical cancer prevention guidelines for low-resource settings. Baltimore (MD): Jhpiego; 2005 (http://www.jhpiego.org/files/CECAP_Manual.pdf, accessed 8 July 2014).
- Bosch FX, Manos MM, Muñoz N, Sherman M, Jansen AM, Peto J, et al.; International Biological Study on Cervical Cancer (IBSCC) Study Group. Prevalence of human papillomavirus in cervical cancer: a worldwide perspective. *J Natl Cancer Inst*. 1995;87:796–802.
- Centers for Disease Control and Prevention (CDC). Revised surveillance case definitions for HIV infection among adults, adolescents, and children aged < 18 months and for HIV infection and AIDS among children aged 18 months to < 13 years – United States, 2008. *MMWR*. 2008;57(RR-10):1–8 (<http://www.cdc.gov/mmwr/pdf/rr/rr5710.pdf>, accessed 18 July 2014).
- Ellerbrock TV, Chiasson MA, Bush TJ, Sun XW, Sawo D, Brudney K, Wright TC Jr. Incidence of cervical squamous intraepithelial lesions in HIV-infected women. *JAMA*. 2000;283(8):1031–7. doi:10.1001/jama.283.8.1031.
- Goldie, S. A public health approach to cervical cancer control: considerations of screening and vaccination strategies. *Int J Gyn and Obs*. 2006;94(Suppl 1):S95–S105. doi:10.1016/S0020-7292(07)60016-2.
- International Agency for Research on Cancer (IARC), World Health Organization (WHO). IARC handbooks of cancer prevention, volume 10: cervix cancer screening. Lyon: IARC Press; 2005 (<http://www.iarc.fr/en/publications/pdfs-online/prev/handbook10/index.php>, accessed 18 July 2014).
- International Agency for Research on Cancer (IARC), World Health Organization (WHO). Cancer fact sheets: cervical cancer. In: GLOBOCAN 2012: estimated cancer incidence, mortality and prevalence worldwide in 2012 [website]. Lyon: IARC; 2014 (http://globocan.iarc.fr/pages/fact_sheets_cancer.aspx, accessed 18 July 2014).
- Minkoff H, Zhong Y, Burk RD, Palefsky JM, Xue X, Watts DH, et al. Influence of adherent and effective antiretroviral therapy use on human papillomavirus infection and

- squamous intraepithelial lesions in human immunodeficiency virus-positive women. *J Infect Dis.* 2010;201(5):681–90. doi:10.1086/650467.
- Muñoz N, Bosch FX, Castellsagué X, Díaz M, de Sanjose S, Hammouda D, et al. Against which human papillomavirus types shall we vaccinate and screen? The international perspective. *Int J Cancer.* 2004;111(2):278–85. doi:10.1002/ijc.20244.
- National Cancer Institute (NCI). Fact sheet: HPV and cancer. Washington (DC): NCI, National Institutes of Health; 2012 (<http://www.cancer.gov/cancertopics/factsheet/Risk/HPV>, accessed 18 July 2014).
- Quinn M, Babb P, Jones J, Allen E. Effect of screening on incidence of and mortality from cancer of cervix in England: evaluation based on routinely collected statistics. *BMJ.* 1999;318:904. doi:<http://dx.doi.org/10.1136/bmj.318.7188.904>
- Schiffman M, Castle PE. The promise of global cervical-cancer prevention. *N Engl J Med.* 2005;353(20):2101–4. doi:10.1056/NEJMp058171.
- Schiffman M, Castle PE, Jeronimo J, Rodriguez AC, Wacholder S. Human papillomavirus and cervical cancer. *Lancet.* 2007;370(9590):890–907. doi:10.1016/S0140-6736(07)61416-0.
- Sellers JW, Sankaranarayanan R. Colposcopy and treatment of cervical intraepithelial neoplasia: a beginners' manual. Lyon: International Agency for Research on Cancer; 2003 (<http://screening.iarc.fr/doc/Colposcopymanual.pdf>, accessed 18 July 2014).
- Shaw RW, Soutter WP, Stanton SL, editors. *Gynaecology*, 3rd edition. Edinburgh: Churchill Livingstone; 2003.
- Tavassoli FA, Devilee P, editors. *Pathology and genetics: tumours of the breast and female genital organs: World Health Organization classification of tumours.* Lyon: International Agency for Research on Cancer; 2003.
- Walboomers JMM, Jacobs MV, Manos MM, Bosch FX, Kummer JA, Shah KV, et al. Human papillomavirus is a necessary cause of invasive cervical cancer worldwide. *J Pathol.* 1999;189:12–9.
-

2

CHAPTER 2. ESSENTIALS FOR CERVICAL CANCER PREVENTION AND CONTROL PROGRAMMES

Chapter 2. Essentials for cervical cancer prevention and control programmes

Key points

- Development of any national cervical cancer prevention and control programme should be done in accordance with the WHO framework of the “six building blocks” to strengthen the overall health system.
- Cervical cancer prevention and control programmes are developed and designed to decrease cervical cancer incidence, morbidity and mortality.
- There are large inequities in access to effective cervical cancer screening and treatment; invasive cervical cancer predominantly affects women who lack access to these services.
- A comprehensive programme should include primary, secondary and tertiary prevention activities (including treatment), and access to palliative care.
- Screening services must be linked to treatment and post-treatment follow-up.
- Monitoring and evaluation are essential components of cervical cancer prevention and control programmes.

About this chapter

This chapter is based on the following WHO guidelines:

A strategic approach to strengthening control of reproductive tract and sexually transmitted infections: use of the programme guidance tool. Geneva: WHO; 2009 (<http://www.who.int/reproductivehealth/publications/rtis/9789241598569/en>).

Cancer control knowledge into action: WHO guide for effective programmes: diagnosis and treatment (module 4). Geneva: WHO; 2008 (http://www.who.int/cancer/publications/cancer_control_diagnosis/en).

Cancer control knowledge into action: WHO guide for effective programmes: palliative care (module 5). Geneva: WHO; 2007 (http://www.who.int/cancer/publications/cancer_control_palliative/en).

Cervical cancer prevention and control costing tool (C4P): user’s guide. Geneva: WHO; 2012 (http://www.who.int/immunization/diseases/hpv/cervical_cancer_costing_tool/en).

Everybody’s business: strengthening health systems to improve health outcomes: WHO’s framework for action. Geneva: WHO; 2007 (http://www.who.int/healthsystems/strategy/everybodys_business.pdf).

Global action plan for the prevention and control of NCDs 2013–2020. Geneva: WHO; 2013 (<http://www.who.int/nmh/publications/ncd-action-plan/en/>).

Human papillomavirus vaccines: WHO position paper, October 2014. *Wkly Epidemiol Rec.* 2014; 89(43):465-92 (<http://www.who.int/wer/2014/wer8943.pdf>).

Monitoring national cervical cancer prevention and control programmes: quality control and quality assurance for visual inspection with acetic acid (VIA)-based programmes. Geneva: WHO; 2013 (<http://www.who.int/reproductivehealth/publications/cancers/9789241505260/en/>).

New vaccine post-introduction evaluation (PIE) tool. Geneva: WHO; 2010 (http://www.who.int/immunization/monitoring_surveillance/resources/PIE_tool/en/).

Prevention of cervical cancer through screening using visual inspection with acetic acid (VIA) and treatment with cryotherapy: a demonstration project in six African countries: Malawi, Madagascar, Nigeria, Uganda, the United Republic of Tanzania, and Zambia. Geneva: WHO; 2012 (<http://www.who.int/reproductivehealth/publications/cancers/9789241503860/en/>).

WHO guidance note: comprehensive cervical cancer prevention and control: a healthier future for girls and women. Geneva: WHO; 2013 (<http://www.who.int/reproductivehealth/publications/cancers/9789241505147/en/>).

The aim of this chapter is to give an overview of how a national cervical cancer prevention and control programme is developed by national decision-makers, and to provide the basic information needed by health-care managers and providers for implementing such a programme at the patient and community levels.

This chapter has two main sections. Section 2.1, What is a comprehensive cervical cancer prevention and control programme?, describes the overall purpose of a comprehensive cervical cancer prevention and control programme and how it should be organized in order to have an impact on the burden of this disease. To be successful, a national programme should include the following key components: primary, secondary and tertiary preventive services, including treatment for pre-cancer and cancer, and palliative care.

Section 2.2, National cervical cancer prevention and control programmes, describes the phases of a national programme: (1) national policy development and establishment of a programme management structure, (2) programme planning and preparation, including an effective referral system, (3) programme implementation, and (4) programme monitoring and evaluation, which must operate across all levels of care. This section provides operational guidelines on the various interventions needed at each level to achieve the goal of reducing the burden imposed by cervical cancer at the individual, community and national levels.

Included in this chapter are tables summarizing commonly encountered challenges to programme planning and implementation and possible options for reducing or eliminating their negative effects. This chapter also includes a list of further reading and useful websites, and links to two practice sheets: a planning and implementation checklist, and descriptions of key performance and impact indicators for national cervical cancer prevention and control programmes.

2.1 What is a comprehensive cervical cancer prevention and control programme?

Any specific national health programme is embedded within a national health system. According to WHO, a strong health system should be built on six building blocks (see Box 2.1). Programme planners should be encouraged to use the WHO framework as a basis for building a national cervical cancer prevention and control programme.

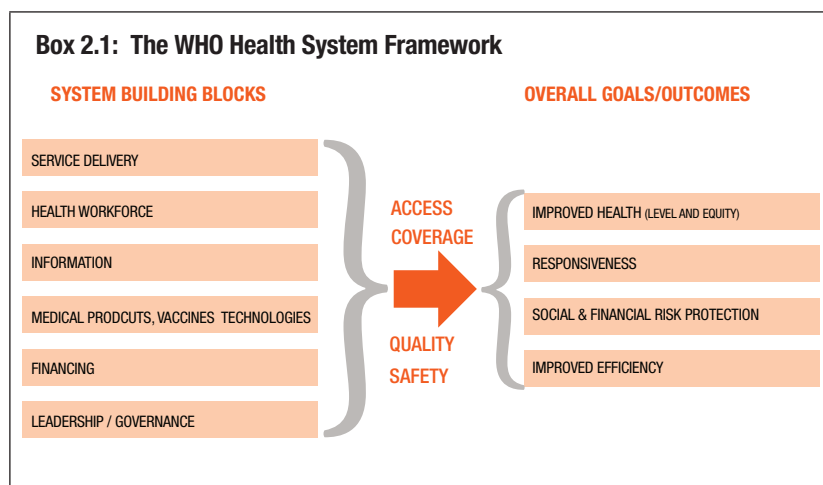

Source: Everybody's business: strengthening health systems to improve health outcomes: WHO's framework for action. Geneva: World Health Organization; 2007.

A cervical cancer prevention and control programme comprises an organized set of activities aimed at preventing and reducing morbidity and mortality from cervical cancer. It is part of the priority actions as stated in the Global action plan for the prevention and control of NCDs 2013–2020.¹ The programme provides a plan of action with details on what work is to be done, by whom and when, as well as information about what means or resources will be used to implement the programme. The achievement of the programme is assessed periodically using a

¹ Available at: <http://www.who.int/nmh/publications/ncd-action-plan/en/>

set of measurable indicators. A comprehensive programme includes the principal evidence-based interventions needed to reduce the high and unequal burden imposed on women and health systems in less developed countries by cervical cancer.

The goal of any comprehensive cervical cancer prevention and control programme is to reduce the burden of cervical cancer by (i) reducing human papillomavirus (HPV) infections, (ii) detecting and treating cervical pre-cancer lesions, and (iii) providing timely treatment and palliative care for invasive cancer, as depicted in Figure 2.1.

2.1.1 Key components of comprehensive cervical cancer prevention and control

A comprehensive programme includes three interdependent components: primary, secondary and tertiary prevention (see Figure 2.1). The interventions included in each component are described in this section.

Figure 2.1: The WHO comprehensive approach to cervical cancer prevention and control: Overview of programmatic interventions over the life course to prevent HPV infection and cervical cancer

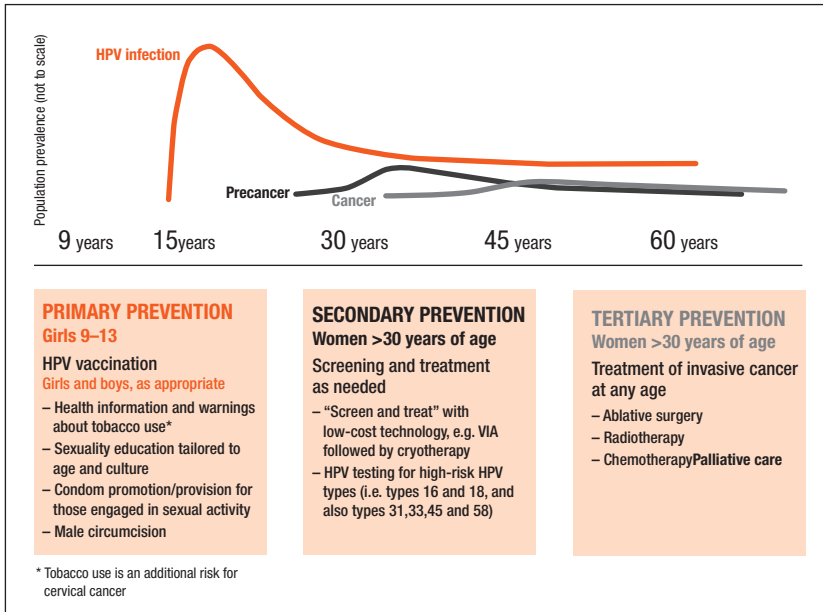

Source: Adapted from WHO guidance note: comprehensive cervical cancer prevention and control: a healthier future for girls and women. Geneva: World Health Organization; 2013.

a. Primary prevention: reduce the risk of HPV infection

The public health goal is to reduce HPV infections, because persistent HPV infections can cause cervical cancer.

Interventions include:

- vaccinations for girls aged 9–13 years (or the age range referred to in national guidelines) before they initiate sexual activity;
- healthy sexuality education for boys and girls, tailored as appropriate to age and culture, with the aim of reducing the risk of HPV transmission (along with other sexually transmitted infections, including HIV) – essential messages should include delay of sexual initiation, and reduction of high-risk sexual behaviours;
- condom promotion or provision for those who are sexually active;
- male circumcision where relevant and appropriate.

For further details on HPV vaccination, see Chapter 4, and for information on HPV infection, see Chapter 1, section 1.3.4.

b. Secondary prevention: screening for and treating pre-cancer

The public health goal is to decrease the incidence and prevalence of cervical cancer and the associated mortality, by intercepting the progress from pre-cancer to invasive cancer.

Interventions include:

- counselling and information sharing;
- screening for all women aged 30–49 years (or ages determined by national standards) to identify precancerous lesions, which are usually asymptomatic;
- treatment of identified precancerous lesions before they progress to invasive cancer.

Even for women who have received an HPV vaccination, it is important to continue screening and treatment when they reach the target age.

For further details about screening and treatment of cervical pre-cancer, see Chapter 5.

c. Tertiary prevention: treatment of invasive cervical cancer

The public health goal is to decrease the number of deaths due to cervical cancer.

Interventions include:

- a referral mechanism from primary care providers to facilities that offer cancer diagnosis and treatment;

- accurate and timely cancer diagnosis, by exploring the extent of invasion;
- treatment appropriate to each stage, based on diagnosis:
 - Early cancer: If the cancer is limited to the cervix and areas around it (the pelvic area), treatment can result in cure; provide the most appropriate available treatment and offer assistance with symptoms associated with cancer or its treatment.
 - Advanced cancer: If the cancer involves tissues beyond the cervix and pelvic area and/or metastases, treatment can improve quality of life, control symptoms and minimize suffering; provide the most effective available treatment and palliative care in tertiary facilities and at the community level, including access to opioids.
- palliative care to relieve pain and suffering.

For further details about diagnosis and treatment of invasive cancer, and palliative care, see Chapters 6 and 7, respectively.

d. The context for delivering the prevention components

The above three prevention components are planned and implemented in conjunction with:

- a structured national approach to community education and mobilization strategies (see Chapter 3 for details); and
- a national monitoring and evaluation system (described in this chapter, section 2.2.3).

2.2 National cervical cancer prevention and control programmes

The objective of a national programme will be to decrease the incidence and prevalence of cervical cancer and associated mortality in the country.

The development and implementation of a national cervical cancer prevention and control programme includes the following phases:

1. national policy development and establishment of a programme management structure
2. programme planning and preparation
3. programme implementation
4. programme monitoring and evaluation.

2.2.1 National policy development and establishment of a programme management structure

a. National policy development

The policy development phase involves deciding on nationally appropriate and feasible options for prevention and control, giving careful consideration to scalability and sustainability, and developing national guidelines based on these policy decisions.

This phase needs to use a cyclical process, since policies need to be updated regularly, as new evidence-based data become available. Service delivery, training, and monitoring and evaluation (M&E) all need to be adapted to the updated policies.

Decisions on national priorities

Vital policy decisions should be carefully drafted based on the national burden of disease, availability of financial and human resources, and the existing structure, quality and coverage of the health-care and education systems. All decisions need to be examined and tailored to make them sustainable and applicable to the real situation in the country. Participants in this phase include national-level policy-makers and decision-makers and political and technical personnel from the country's Ministry of Health (MOH), as well as representatives of professional medical associations, such as the obstetric/gynaecology association, medical oncology association, nurses association, etc.

Areas for policy discussions and decisions may include the following:

- Review and, if necessary, update existing national guidelines and protocols for health workers at all levels.
- Conduct policy dialogue and build consensus with stakeholders, including health-care providers, public health authorities, health insurance executives and medical professional associations, among others.
- Gather and review country data to answer these key questions:
- Where is the problem?
 - What should the priority areas be in addressing the problem?
 - What are the costs of delivering the services and how will they be financed?
- Assess the affordability, cost-effectiveness and sustainability of introducing HPV vaccines and the screen-and-treat approach to cervical cancer prevention and control, as well as of a referral system for treatment at the national level.
- Determine whether existing services have the capacity to add cervical cancer prevention and control services (including introduction of HPV vaccination), and plan how to address any shortcomings or deficiencies.

- Consider strategies for programme introduction, including when, how (phased or not) and where (if not nationwide) to introduce HPV vaccine and screening and treatment services; if not nationwide initially, include a tentative future expansion plan for reaching all at-risk women and girls in the country.
- Choose service-delivery strategies and possible venues for HPV vaccine delivery, and for screening.
- Select which HPV vaccine is to be used in the country.
- Determine which methods will be used for screening and treatment of pre-cancer.
- Determine which hospitals will serve as reference centres for cervical cancer treatment.
- Determine the age range, frequency, coverage level, time frame for achieving the coverage, and the health-care level for service delivery for each of the selected interventions.
- Establish a training plan for health-care providers and community health workers.
- Establish a plan for information, education and communication (IEC) on cervical cancer, including training for managers and providers on how to implement IEC initiatives targeting consumers and the media.
- Plan ahead for M&E; determine the key indicators, frequency of data collection and methods for recording and analysing data.

To facilitate decision-making on cervical cancer prevention and control strategies, programme managers and policy-makers need information on the projected programmatic costs of introducing cervical cancer interventions. The WHO cervical cancer prevention and control costing tool (C4P) has been developed to assist governments to estimate the costs of cervical cancer interventions over a five-year planning horizon.² Module 1 of the tool focuses on HPV vaccine introduction while Module 2 focuses on cervical cancer screening and treatment.

Scalability and sustainability considerations

Two important factors that should be taken into consideration when setting up or improving a cervical cancer prevention programme are sustainability and scalability.

The costs of the cervical cancer prevention and control programme should be included in the national health budget. Planning for sustainability should include determining what is feasible in terms of available financial resources, human resources and infrastructure, with a view to equitable implementation of the various components of cervical cancer prevention and control. Sustainability planning may also include the search for external support from bilateral and multinational agencies

² The C4P is available at: http://www.who.int/immunization/diseases/hpv/cervical_cancer_costing_tool

and large foundations with proven records. For example, for HPV vaccine introduction, support from the GAVI Alliance is available for five years, with the requirement that the country must plan for long-term sustainability beyond the initial five years.

For countries with limited resources that initially can only implement a cervical cancer programme with limited coverage, future scalability is an important consideration. Wide coverage can be achieved using a step-wise incremental approach over a defined time period, based on the feasibility and availability of resources. Plans for scale-up should prioritize women who have not had access to health services and those groups with the greater burden of cancer deaths and suffering. Programme managers have to set realistic targets depending on the number of providers, the available hours of work and the size and sociocultural characteristics of the target population in the geographical area being considered.

Development of national guidelines

The above decisions will inform the development of guidelines for national cervical cancer prevention and control. This activity needs to be conducted collaboratively by national policy-makers and MOH representatives in consultation with key stakeholders, such as health-care providers, medical professional associations and women's groups. It is also important to include national and international cervical cancer experts and representatives of nongovernmental organizations with experience with cervical cancer prevention and control.

Guidelines must include information on clinical and public health requirements for a successful programme. The elements that should be defined in the guidelines are listed below.

Clinical requirements:

- HPV vaccination: age range, schedule and clinical procedures
- Screening: age range, screening test(s), screening interval, diagnostic criteria, follow-up recommendations and clinical procedures
- Treatment of precancerous lesions: treatment methods and clinical procedures
- Treatment of invasive cancer: treatment methods, clinical procedures and palliative care
- Referral system.

Public health requirements:

- HPV vaccination: vaccination strategy, coverage, safety standards, reporting on adverse events following immunization (AEFI)

- Screening: infrastructure, equipment and supply requirements, quality assurance and quality control approach, coverage
- Treatment of precancerous lesions and invasive cancer: infrastructure, equipment and supply requirements, timeliness of treatment, quality assurance and quality control approach
- M&E: key performance and impact indicators for each service component, plan for incorporation of necessary data into a management information system (MIS).

b. Establishment of a programme management structure

To facilitate planning, implementation and monitoring of a national cervical cancer prevention and control programme, it is important to establish a national cervical cancer management team, with clear responsibilities and accountability for the programme.

As shown in Figure 2.2, two key groups should be developed at the national level, led by a designated national coordinator:

- A multidisciplinary management team responsible for the programme and composed of representatives from various national departments and programmes;
- A stakeholder advisory group composed of representatives of appropriate segments of civil society.

Members of both groups would be selected and invited to participate by the MOH.

Figure 2.2: Proposed structure of a national cervical cancer management team

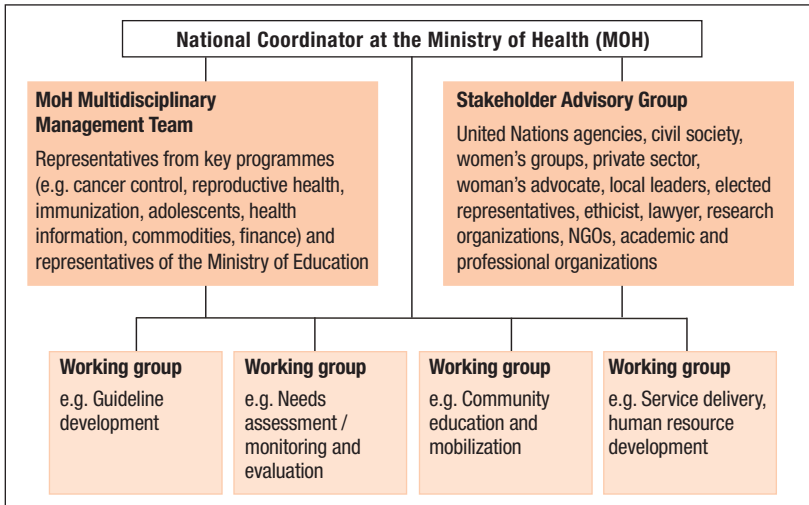

Role of the national coordinator

The role of the national coordinator would include the following activities and responsibilities:

- Raise awareness within the MOH at different levels of the health system on the seriousness of national cervical cancer morbidity and mortality, and the potential to prevent most deaths with relatively few resources.
- Advocate to make cervical cancer prevention and control a priority within the MOH, including allocation of a continuous and sustainable supply of resources to the programme.
- With input and advice from senior MOH administrators and managers, establish and develop representative membership, roles and responsibilities for the multidisciplinary management team (in accordance with the structure shown in Figure 2.2).
- In collaboration with the team, organize and schedule regular team meetings.
- In consultation with the team and with senior MOH administrators and managers, identify and invite key stakeholders from civil society to form the stakeholder advisory group (in accordance with the structure shown in Figure 2.2), and establish group functions and responsibilities.
- In collaboration with the stakeholder advisory group, organize periodic meetings to update them on the status of the cervical cancer prevention and control programme and seek their input on the key steps.
- Be the principal link and coordinator between and within all service levels in the national cervical cancer prevention and control programme, as well as with other national programmes (such as cancer control, immunization and adolescent health) and with other partners.
- Prepare a proposal to ensure that all necessary elements for programme implementation will be in place at all health-care facilities, including equipment, supplies, and trained and supervised staff. This process should involve regional management personnel, and proposals may need to be adapted for different regions.
- Produce annual reports on the performance of the cervical cancer prevention and control programme, based on the established programme indicators.

Role of the national multidisciplinary management team

For the national multidisciplinary management team to be effective, the MOH needs to provide it with the appropriate mandate, decision-making authority, autonomy and resources to direct the planning, implementation, monitoring and evaluation of the national programme.

As the national cervical cancer prevention and control programme has several key components, the management team will involve representatives from other national programmes, including community education and social mobilization, immunization, reproductive health, adolescent and school health, sexually transmitted infections and HIV, oncology, M&E, etc. Local and regional representation is important. The overall size of the team may range between approximately 10 and 25 people, depending on the size of the country and the structure of the national programme.

Key responsibilities of the national multidisciplinary management team (MMT):

- Develop national plans for the various components and elements of the programme.
- Develop a detailed budget for planning, implementation, monitoring and evaluation of the programme.
- Establish systems for various elements of the programme including: recording data in the existing management information system (MIS); periodic reports (frequency, content and audience); distribution and maintenance of equipment and supplies, among others.
- Through monitoring and evaluation activities, assess whether services are functioning effectively and ensure the implementation of corrective action in a timely manner, as needed.
- Using a multipronged, evidence-based approach, build awareness of programmatic components at the primary and secondary levels and ensure that health-care providers are kept up-to-date with technical information.
- Document and address any misinformation and misconceptions among health-care providers and communities.
- Conduct regular monitoring and evaluation of programme activities.

Principal functions of the stakeholder advisory group:

- Provide support and input to the MOH multidisciplinary management team (MMT) to create a cervical cancer prevention and control programme and/or expand, update or strengthen an existing one.
- Attend regular meetings to review past activities, plan new ones and document planned achievements and/or lack of them.
- In collaboration with the MMT, form and delegate working groups to focus on specific elements of the national programme, including (but not limited to) those shown in Figure 2.2.
- Advise and participate in national, regional and local meetings with the MMT as necessary to define the programme.

c. Challenges to the development of effective cervical cancer prevention and control strategies

As with all new programmes, challenges can be expected to arise at all levels of the health system pyramid when a national cervical cancer prevention and control programme is first contemplated and developed. There are actions that can be taken at all levels to mitigate the negative effects of these challenges.

Table 2.1 describes the most common challenges and suggests possible actions to address these at the appropriate levels of the health system. Many additional actions can be developed as appropriate in each country based on careful review of the updated contents of all chapters of this second edition of the guide.

Table 2.1: Potential challenges at the policy and managerial levels, and suggested actions for addressing them

Challenges	Suggested actions to reduce any negative impact
<ul style="list-style-type: none"> Lack of awareness and prioritization of women's sexual and reproductive health, including cervical cancer, sexually transmitted infections (STIs), etc. 	<ul style="list-style-type: none"> Work with programme managers and advisory group members to increase the visibility of the burden imposed by cervical cancer, i.e. high morbidity and mortality among young women, negative impact on society, socioeconomic disparities and high costs to the health system. Conduct advocacy to increase awareness among decision-makers about the need for prioritization of women's sexual and reproductive health, including STIs.
<ul style="list-style-type: none"> Lack of strong leadership 	<ul style="list-style-type: none"> Identify and assist champions of the cervical cancer reduction cause at a higher level. Identify and support national coordination and accountability.

Challenges	Suggested actions to reduce any negative impact
<ul style="list-style-type: none"> Inadequate use of available local/national epidemiological data to convince policy-makers and others with influence on policy 	<ul style="list-style-type: none"> Improve utilization of available local, national or regional data or, if it does not exist, provide data or estimates from international sources: <ul style="list-style-type: none"> World Health Organization (WHO) estimates (www.who.int/gho/ncd/mortality_morbidity/cancer). The GLOBOCAN project of the International Agency for Research on Cancer (IARC) provides national estimates on cervical cancer incidence and mortality (globocan.iarc.fr). The ICO Information Centre on HPV and Cancer provides additional information on country-specific data and programmes (www.hpvcentre.net). If necessary, conduct country-specific surveys.
<ul style="list-style-type: none"> Non-inclusion of cervical cancer prevention among national health plans within the Ministry of Health 	<ul style="list-style-type: none"> Advocate for the MOH to include cervical cancer prevention activities. Provide cost-effectiveness information to policy-makers and those with influence on policy.³
<ul style="list-style-type: none"> National policies and guidelines need updating 	<ul style="list-style-type: none"> Develop, adapt or update national policies and appropriate guidelines.
<ul style="list-style-type: none"> Lack of resources, such as funding, supplies, equipment and infrastructure 	<ul style="list-style-type: none"> Include a line item for progressive implementation of the national programme in the National Health Annual Budget, based on information about programme costs and available resources. Ensure procurement of supplies, equipment and infrastructure.
<ul style="list-style-type: none"> Lack of an effective and functioning referral system within the programme services 	<ul style="list-style-type: none"> Utilize this guide to establish services with an effective and functioning referral system.

³ Available at: <http://www.who.int/immunization/diseases/hpv/resources>

2.2.2 Programme planning and preparation

A cervical cancer prevention and control programme requires detailed planning and preparation because:

- it requires involvement, commitment and close coordination between and within several existing ministries (e.g. MOH, Ministry of Education, Ministry of Gender Equality, among others) and multiple programmes within them (e.g. within the MOH, relevant programmes include cancer control, immunization, reproductive health and adolescent health, among others);
- it requires consideration of the various responsibilities and linkages between the structures at different levels of the health system: national, regional, clinic and community (see Figure 2.3);
- it involves collaboration with nongovernmental organizations, women's groups and professional associations, such as paediatricians, gynaecologists, oncologists, primary care physicians and nurses; and
- it requires active participation of key local stakeholders.

a. Planning: key programmatic considerations

Based on policy decisions that have been made regarding the programme, to move forward with planning and designing an organized programme, the key programmatic considerations include:

- providing an opportunity for health-care providers to provide input on programme planning and preparation, in line with national guidelines;
- assessing the service delivery needs at all service delivery facilities and building on what is already available at each, with the aim of sharing resources;
- developing an action plan for community education and mobilization, and developing appropriate materials;
- procuring and distributing equipment and supplies and setting up local repair/maintenance and distribution systems for them;
- establishing and maintaining an effective referral system;
- establishing a health management information system (paper-based or computerized) to enable monitoring and evaluation;
- developing a monitoring and evaluating strategy to regularly assess the programme and institute corrective action in a timely manner;
- assuring a well-designed and implemented provider training programme including post-training follow-up and periodic refresher training;
- providing for supportive supervision to detect and correct any problems with health services, to keep them in line with national standards; and
- establishing implementation strategies with district managers and local decision-makers.

Figure 2.3 : Examples of programmatic considerations at different levels of the health system

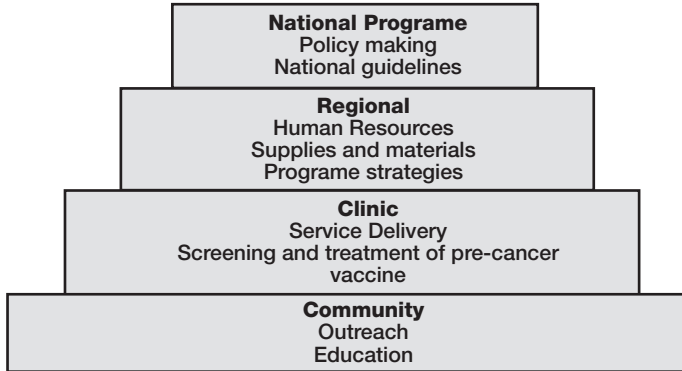

b. Steps in preparing to launch a new national cervical cancer prevention and control programme using a strategic approach

A strategic approach to implementing a new national cervical cancer prevention and control programme requires several activities to be completed prior to launching services. The four main steps are described in this section.

Determine the target population

It is crucial to having a clear definition of the target populations for HPV vaccination and cervical cancer screening, and to know the location and size of these populations. This information can be obtained relatively easily in countries where population records are kept and updated routinely as part of health services or by using census data from the national statistics authorities. In countries where this is not done, regional population estimates from the United Nations can be used.⁴

Determining the target population is important for the following reasons:

- to provide the denominator for calculating coverage as a core performance indicator
- to estimate the needed supplies, staff numbers and time, and other resources
- to assist development of the action plans for delivering and monitoring services.

Conduct a needs assessment

A needs assessment involves visiting, observing, interviewing key informants and stakeholders and documenting existing resources. The following information needs to be obtained:

- the location and condition of all facilities in the selected implementation area, including details about the infrastructure, equipment and supplies;

⁴ Available at: <http://www.un.org/popin/data.html>

- the capacity of all cadres of providers for adding cervical cancer prevention and control services;
- the quality of general services provided at each facility from the point of view of clinic personnel at all levels (from managers to cleaning staff) and from community representatives, including women and girls in the target age groups (both users and nonusers of services);
- the schedule of service hours per day and per week, and out-of-pocket costs for all or selected services, if any;
- the existence and functionality of a referral/counter-referral system;
- the existence of an adequate system for adding data on cervical cancer services, as these data will be needed for monitoring and evaluating the new programme;
- space available for cold chain storage of new vaccines, to determine whether expansion is needed to provide dedicated space for this purpose in the immediate future.

Map and leverage support from additional local contributors

As cervical cancer prevention and control involves collaboration among various public and private organizations, mapping their locations in the area of implementation, as well as their infrastructure and human resources, can be very useful. It is important to identify and personally contact all potential local contributors, and leverage their collaboration. These potential contributors would include organizations identified for their experience and expertise in provider training, community sensitization and mobilization, design and implementation of vaccination programmes, monitoring and supportive supervision, and establishment and monitoring functionality of the cold chain, among others.

Decide on and design an introduction strategy

Countries with limited resources can consider initiating cervical cancer prevention and control as a demonstration project in a selected geographic area. This strategy can be very valuable as a way of monitoring elements that may need to be modified or improved before services can be scaled up.

Geographic expansion can be planned using a step-wise approach, applying lessons learnt in the demonstration project and incorporating, if applicable, emerging new evidence-based technology. Scale-up can proceed gradually until the programme serves the entire country.

2.2.3 Programme implementation

An operational framework must be developed for the activities that need to be undertaken at different levels of the health care system. See Figures 2.3 and 2.4.

At the community level, activities include creating awareness, providing education, and outreach efforts targeting girls aged 9–13 years and women aged 30–49 years (see Chapter 3, and sections 4.3 and 4.4 in Chapter 4). For patients with advanced disease, the family and community are the principal contributors to palliative care after a woman is discharged from hospital (see Chapter 7: Palliative care).

At the primary- and secondary-level health-care facilities, the screening test or tests that have been selected at the policy development stage can be performed, and clients who screen positive can be treated with cryotherapy or loop electrosurgical excision procedure (LEEP). For lesions that do not meet the eligibility criteria for these treatments, women must be referred to the tertiary level of health services for further evaluation and treatment (see Chapters 5 and 6 on diagnosis and treatment of pre-cancer and invasive cancer, respectively).

Training of health-care providers, supervision, and monitoring and evaluation of services are required, and must be performed continuously at all levels.

Figure 2.4: Example of organization of screening, referral and treatment services

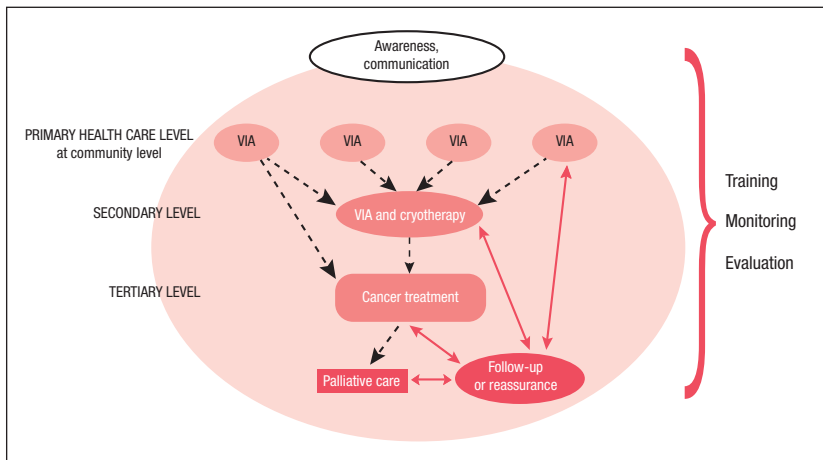

Source: Prevention of cervical cancer through screening using visual inspection with acetic acid (VIA) and treatment with cryotherapy: a demonstration project in six African countries: Malawi, Madagascar, Nigeria, Uganda, the United Republic of Tanzania, and Zambia. Geneva: World Health Organization; 2012.

a. Role of health-care providers in programme implementation

Health-care providers at all levels, as well as managers, supervisors and training facilitators, contribute to the effectiveness of a national cervical cancer prevention and control programme.

Health-care providers' key roles in implementing an effective programme include all of the following:

- delivering relevant preventive, curative and rehabilitative health services to the eligible population, as determined by the national guidelines and service protocols;
- participating in relevant training and refresher training to keep knowledge and skills up-to-date;
- keeping informed of any changes to service recommendations or interventions and adapting clinical practices accordingly;
- providing correct information to the community in clear terms using the local language so that people in the target populations will make use of (and benefit from) these services;
- ensuring that services are provided in a timely manner and that referral services are working efficiently;
- maintaining meticulous records and registers, which are needed to calculate the monitoring indicators as a basis for assessing whether the goals of the programme are being achieved; and
- assuring and continuously improving the quality of services at all levels.

b. Integrating cervical cancer services with other health services

Integrating services or, at a minimum, informing and arranging linkages between services enables holistic health management for women. The introduction of new cervical cancer prevention and control services provides an opportunity to take a comprehensive approach to women's health.

Integrating cervical cancer screening and treatment with other reproductive health services

Links are needed between the demand for and the supply of health services. On the demand side, many women visit health-care facilities seeking advice on a variety of ailments, especially those related to reproductive health. But they may not be aware of the importance of cervical cancer screening and treatment in particular.

On the supply side, primary care facilities often have only one mid-level health-care provider who is tasked with managing all reproductive health care for women (i.e. family planning, STI management, antenatal care and behaviour change

communication). Often this primary care provider does not have the training and/or the necessary equipment to provide pre-cancer screening for women over the age of 30, and might therefore miss the only opportunity to offer this service to a particular client. If screening is not possible at the primary care facility, the provider can, at least, determine the need for this service, educate the client and refer her to the secondary-level facility.

Integrating HPV vaccination into other primary prevention services

The HPV vaccination strategy offers valuable opportunities for integration with other school health services and adolescent-friendly primary health care services. Interventions can include screening for common nutritional deficiencies, physical disabilities and illnesses, as well as providing preventive health information, such as information on the dangers of tobacco use, on contraception to prevent unplanned pregnancies, and on condom use for the dual purpose of preventing pregnancies and STIs, including HIV/AIDS.

Integrating HIV and cervical cancer screening and treatment services

WHO strongly recommends that in countries with a high prevalence of HIV any contact between a client (or patient) and a health worker be used as an opportunity for HIV counselling and testing (HCT) and provision of appropriate education and care. The integration of cervical cancer and HIV services can occur in two ways:

- Women attending HCT services should be encouraged to seek cervical cancer screening if they are aged 30 years and above; if they are living with HIV and have never had cervical screening, they should be encouraged to get screened immediately regardless of their age, or to get screened within three years if they have previously had a negative cervical screening result.
- Women attending for cervical cancer screening in countries with a high prevalence of HIV should be encouraged to attend HCT services if they have not been tested for HIV recently.

c. Integrating services with screening for other cancers: the case of breast cancer

The same principles for implementing a successful and high-quality cervical cancer screening programme apply to screening for other cancers, such as breast cancer. The experience and lessons learnt organizing and implementing a programme for cervical cancer could provide the basis for developing a programme for breast cancer. Differences in the target age range for breast cancer screening (usually women aged 50 years and older) need to be considered when approaching women at cervical cancer screening services. At a minimum, cervical cancer services offer an opportunity for building awareness about breast cancer and linking with breast cancer screening services. Similarly, women undergoing breast cancer screening

should be asked about cervical cancer screening if they are in the recommended age range for cervical cancer screening, and those who have never been screened should be particularly encouraged to do so.

d. Challenges to programme implementation

Challenges are not only found at the policy development level, but also arise during programme implementation at the level of the health-care facility and the community, in addition to barriers affecting families and individuals. Table 2.2 summarizes these challenges and provides suggestions for reducing any negative effects of these challenges.

Table 2.2: Potential challenges in the implementation phase, and suggested actions for addressing them

Challenges	Suggested actions to reduce any negative impact
Regional/local health-care facility level	
<ul style="list-style-type: none"> The presence of individuals and groups that resist vaccinations, including HPV vaccination, and are engaged in diffusion of misinformation 	<ul style="list-style-type: none"> Develop, pilot test and widely broadcast effective multimedia campaigns to promote the benefits of vaccinating girls against HPV and to explicitly counter misinformation on the risks of vaccination (see Chapter 4, and also the next section in this table on suggested actions at the community and primary care provider level).
<ul style="list-style-type: none"> Insufficient numbers of trained and competent providers 	<ul style="list-style-type: none"> Train, maintain and update adequate numbers of competent providers for all service levels; this may require a certain level of task shifting and sharing among staff members. Provide nonmonetary incentives for punctual attendance by clients, and to reward high quality of services.

continued next page

Challenges	Suggested actions to reduce any negative impact
<ul style="list-style-type: none"> Community members seek the advice of local and traditional providers, community leaders, and popular national figures who are not aware of the burden of disease and the potential for effective prevention and treatment 	<ul style="list-style-type: none"> Local-level advisors can play an important role in clients' acceptance of services; they should participate in evidence-based information activities and should be enlisted to help reduce misinformation and negative attitudes (see Chapter 3 for details on communication methods and messages).
<ul style="list-style-type: none"> Poor quality of screening test performance, due both to the test technology and provider errors 	<ul style="list-style-type: none"> Choose evidence-based algorithms for pre-cancer screening tests in accordance with national guidelines, available resources and infrastructure, to ensure equitable access and the best performance possible (see Chapter 5 for details on screening methods).
<ul style="list-style-type: none"> Long distances to health centres and limited hours of operation, which reduce access to services 	<ul style="list-style-type: none"> Revise the opening and closing hours of health services to take into account working women's schedules, and work with the community to help women get to the facility, thus increasing access to screening, follow-up and treatment services. Develop strategies to ensure access to services for all target-age women, regardless of socioeconomic status, distance from services, and other local cultural factors.
<ul style="list-style-type: none"> Lack of a system for inviting women for screening and for follow-up care Requirements for women to return for frequent health services, which lead to more women being lost to follow-up care 	<ul style="list-style-type: none"> Define a strategy for reaching the women who need follow-up services, and for convincing them that these services are necessary, with a view to reducing the bottlenecks in services. Provide screening and treatment of pre-cancer lesions at the same visit.

Challenges	Suggested actions to reduce any negative impact
<ul style="list-style-type: none"> • High cost of vaccines, screening or treatment services 	<ul style="list-style-type: none"> • Plan and implement local strategies for decreasing costs of vaccines, screening and treatment services. • Engage with international and regional partners. • Negotiate with manufacturers.
Community and primary care provider levels	
<ul style="list-style-type: none"> • Lack of awareness among communities and health personnel about cervical cancer as a health problem in general, and about the need for screening – even in the absence of symptoms 	<ul style="list-style-type: none"> • Using appropriate approaches, provide education and awareness-raising interventions for the entire community, community leaders and other key people in the community, as well as for primary care providers and nonprofessional clinic support staff, regarding the scientific evidence about the natural history of cervical cancer, its link to HPV and the availability of effective prevention and early treatment.
<ul style="list-style-type: none"> • Negative attitudes and misinformation about the risks of HPV vaccination, misconceptions that vaccinating pre-sexual girls promotes sexual activity, and beliefs or norms that inhibit people from discussing diseases of the genital tract 	<ul style="list-style-type: none"> • Use focus group discussions and interviews to investigate and discuss prevailing misconceptions and negative attitudes regarding HPV vaccines and diseases of the genital tract in general, and cervical cancer in particular, and respond by providing evidence to the contrary using nontechnical language (use this guide as a resource). • During training and education efforts involving key people from the community, attempt to identify those who were against the services but who have now understood and converted to acceptance of the information; train these individuals to conduct counselling and community education (provide them with useful materials and tools for this activity).

Challenges	Suggested actions to reduce any negative impact
<ul style="list-style-type: none"> Individual, social or cultural factors that act as barriers preventing women from seeking preventive health services 	<ul style="list-style-type: none"> Address these barriers, which may include: gender inequality and violence, socio-demographic marginalization (e.g. indigenous or tribal people, or refugees), economic status, religious beliefs, etc.
<ul style="list-style-type: none"> Lack of financial support for women and families for screening costs and loss of wages (the majority of women at risk for cervical cancer are not covered by social or health insurance) 	<ul style="list-style-type: none"> If social or health insurance exists, make sure these costs are covered in it.

e. Develop an action plan for information and education, training and supportive supervision

As with other programme components, the action plan for IEC, training and supportive supervision should be developed based on the needs assessment and mapping exercises described earlier, in section 2.2.2.

This action plan should include the following activities:

- Conduct focus group discussions and/or interviews with women and girls in the target age groups to better understand their knowledge, perceptions and needs; this information will help programme managers to tailor the training curricula for health-care providers, so that they can provide the appropriate information and support to clients, thus assuring high levels of participation in screening and compliance with treatment and follow-up services.
- Based on available information about existing service capacity and local needs, develop and implement staff training curricula, as well as IEC materials and patient education tools.
- Prepare records and registers for documentation of services provided; this is important not only for patient management and programme evaluation, but also for supervision and evaluation of provider performance.
- Provide training for all health-care providers and programme managers to enable them to explain clearly to patients what they can expect when they undergo certain procedures (see Chapters 3–7 for information on counselling messages and mobilization plans for HPV vaccination, and screening and treatment of pre-cancer and invasive cancer).

- Provide training to data operators, equipment maintenance staff, programme supervisors and laboratory technicians on the technical details of their tasks.
- Educate primary- and secondary-level providers about treatment of invasive cancer and palliative care, so that they are knowledgeable about the services provided at the tertiary level.

The duration of training courses should be sufficient to achieve proficiency in the majority of learners and should include theoretical components, simulation using anatomical models, and hands-on clinical training. Training on methodologies that will be used in services should be flexible to permit integration of new technologies as they emerge.

Common challenges encountered in training include:

- insufficient hands-on (practical) training due to a small case load
- lack of focus on competency-based training
- insufficient post-training follow-up and supportive supervision
- lack of refresher courses
- training centres not reflective of resources available at service delivery sites.

When facing some of these challenges, it may help to bear the following points in mind. While some participants acquire new knowledge and skills quickly, others may need additional time. Extension of practical training beyond the training course can be arranged by having experienced providers take on trainees as apprentices at their facilities on a weekly or rotational basis after they have completed the basic course. It is crucial to ensure that all providers are confident in their ability to provide the service to the established standard before they commence service provision. Post-training supervision, the use of job aids, algorithms and other relevant learning tools to reinforce quality performance should be built into the training plan and subsequent programme management.

f. Other components that must be in place for efficient and safe service delivery

Procurement and maintenance of equipment and supplies

The needs assessment during the planning and preparation phase will provide vital information about the essential equipment and supplies that need to be procured. Strategies for distributing and storing equipment and for regular replenishment of supplies (including consumables, spare parts and reagents) must be established. In addition, an efficient local system for repair and maintenance will be needed, in order to avoid interruption of services or the need to reschedule patients due to broken or malfunctioning equipment. Such interruption of service may discourage clients from returning, and may damage the image of the service quality for actual or potential patients.

An infection prevention strategy

Proper management of medical waste items and decontamination and sterilization of reusable equipment is necessary to minimize the spread of infection and harm to clinic personnel, patients and the local community (see Annex 3).



Infection prevention and control

The strategy should provide clear instructions on the following points:

- proper management of medical waste, including sorting, transportation and disposal;
- a system for disposal of used vials and syringes used for HPV vaccination (see Practice Sheet 4.4 for the essential elements of injection safety for quality services);
- processing of contaminated reusable equipment according to international standards, including decontamination with a bleach solution, rinsing and washing, high-level disinfection or sterilization; and
- use of proper protective gear by health-care staff responsible for the management of contaminated waste and/or reusable equipment, including protective clothes, heavy gloves and masks if necessary.



Injection safety

A national reference laboratory

This will be necessary for quality assurance and quality control when HPV tests are introduced in a programme.

The checklist in Practice Sheet 2.1 may be helpful in planning and implementing the cervical cancer control programme. Also, please consult the list of further reading at the end of this chapter for useful publications and websites containing up-to-date evidence-based information on strategic approaches to programme planning and implementation.



Checklist

2.2.4 Programme monitoring and evaluation

Monitoring and evaluation (M&E) in any health programme is conducted to ensure that the processes and systems are developed and adhered to in such a way that the deliverables are of good quality and maximize the benefits to the target population. The key indicators to use for M&E for a cervical cancer prevention and control programme can be found in the WHO/PAHO 2013 publication *Monitoring national cervical cancer prevention and control programmes: quality control and quality assurance for visual inspection with acetic acid (VIA)-based programmes*.⁵

⁵ Available at: <http://www.who.int/reproductivehealth/publications/cancers/9789241505260/en/>

Stakeholders should be involved from the strategic planning stage to ensure that the necessary results will be obtained from the programme and that appropriate corrective measures will be applied as needed. Basic health information systems, either manual (using records and registers), computerized or a combination of both, should be put in place and the data required for M&E should be collected regularly.

Cancer registries are important tools for collecting information on cancer cases and deaths. These data can be analysed to obtain information on the occurrence and trends of cancer in a defined population and to assess the impact of the cervical cancer prevention and control programme. If it is too difficult initially to implement cancer registries across the entire country, sentinel sites representative of different populations can be established and, as lessons are learnt, can be modified and scaled up until there is nationwide coverage. For more information on cancer registration, consult the website of the Global Initiative for Cancer Registry Development (GICR) of the International Agency for Research on Cancer (IARC).⁶

a. Monitoring

According to the WHO Health Systems Strengthening Glossary,⁷ monitoring is the continuous oversight of an activity to assist in its supervision and to see that it proceeds according to plan. It involves the specification of methods to measure activity, use of resources, and response to services against agreed criteria.

Monitoring with appropriate corrective action requires a functioning system for gathering, storing and disseminating health information, a supervisory system to ensure adherence to standards, participatory and continuous quality improvement, and local problem-solving methods implemented with the involvement of providers and community members. This sub-section provides further details on health information systems, suggests tools for self-assessment and local problem-solving, and gives information on supportive supervision used for cervical cancer prevention.

Two specific activities in a cervical cancer prevention and control programme that rely heavily on monitoring are continuous quality improvement of service provision and monitoring adverse events following immunization (AEFIs) (see Chapter 4 and Practice Sheet 4.6 for specific issues related to M&E for an HPV vaccination programme).



Continuous quality improvement of service provision should be carried out periodically with remedial action instituted in a timely manner. Improving quality is a responsibility of all staff and should involve all cadres. Methods that can be adapted and used to monitor and improve the quality of services are:

⁶ Available at: <http://gicr.iarc.fr>

⁷ Available at: http://www.who.int/healthsystems/hss_glossary/en/

- **Self-assessment and local problem-solving:** These are participatory methods that should involve all cadres of providers as well as representative members of the community. EngenderHealth's COPE® (client-oriented, provider-efficient services) self-assessment process has produced several tools that can be adapted to assist in this effort: client interview guide, client flow analysis, and COPE action plan.⁸
- **Supportive supervision:** This must be done periodically and the process should be facilitated by trained supervisors. Key roles of the supportive supervision team include:
 - observing all aspects of service provision, if applicable (e.g. client registration, counselling, consent procedures, administration of vaccinations, screening, treatment of pre-cancer, infection prevention practices and documentation);
 - reviewing site-level data relating to recruitment, HPV vaccination coverage (fully and partially immunized), screening and treatment rates, loss to follow-up, rates of AEFIs, etc.; and
 - mentoring and updating the skills of health workers and working with them to solve any issues noted about the facility-based services or outreach services.

b. Evaluation

Evaluation is defined by the WHO Health Systems Strengthening Glossary as the systematic and objective assessment of the relevance, adequacy, progress, efficiency, effectiveness and impact of a course of actions, in relation to objectives and taking into account the resources and facilities that have been deployed.

An evaluation plan, developed with the active participation of stakeholders, needs to define the following:

- the person or persons in the multidisciplinary management teams who will be responsible for evaluating the services;
- the resources and services that will be evaluated and the methods of the evaluation;
- the data that will be collected, and the definition of the key performance and impact indicators for cervical cancer prevention and control (see Practice Sheet 2.2 for the key indicators);
- the manner in which corrective action will be taken wherever gaps are detected; and
- the budget for implementing the evaluation.



Key indicators

⁸ Available at: <http://www.engenderhealth.org/pubs/quality/cope.php>

c. Core indicators

Core indicators to use for monitoring and evaluating services of a comprehensive cervical cancer prevention and control programme include performance and impact indicators. The core indicators are those that every country is strongly encouraged to adopt, as they provide fundamental information for monitoring and evaluating programme progress and impact as well as global information for intra- and intercountry comparisons (for examples, see Chapter 1, section 1.1.2, which presents data on the global epidemiology of cervical cancer).

Performance indicators for HPV vaccination:

- Vaccine coverage of the target population: proportion of girls fully vaccinated by the age of 15 every year (measured using the WHO–UNICEF joint reporting form)
- Rate of AEFIs: number of AEFIs reported every year (see Chapter 4 for more details).

Performance indicators for cervical cancer screening and treatment:

- Coverage of the target population:
 - i. percentage of women aged 30–49 years who have been screened at least once since age 30 (this can be assessed using a survey of women aged 30–49 years that includes a question about whether they have been screened at least once)
 - ii. percentage of women aged 30–49 years who have been screened that year (information can be obtained from service logbooks, taking care to disaggregate first screen from repeat screen)

Note: For both of the above indicators, the denominator is the number of women in the population aged 30–49 years, and it is important to disaggregate the data in five-year groups.

- Screening test positivity: percentage of screened women aged 30–49 years with a positive result in the previous 12-month period (information can be obtained from logbooks)
- Treatment rate: percentage of screen-positive women completing appropriate treatment for pre-cancer and treatment for invasive cancer in the previous 12-month period (information can be obtained from logbooks).

Impact indicator:

- Cervical cancer age-specific incidence and mortality: age-specific incidence and mortality of cervical cancer in the target population.

Refer to Practice Sheet 2.2 for the definitions of the core performance and impact indicators, the methods of calculation and the cut-off level for instituting corrective action (other indicators are also described in the same practice sheet).



Key indicators

For more information, refer to the WHO/PAHO document *Monitoring national cervical cancer prevention and control programmes: quality control and quality assurance for visual inspection with acetic acid (VIA)-based programmes* (2013).⁹

2.3 Achieving cervical cancer prevention and control

Cervical cancer prevention and control can be achieved if:

- a national policy and national guidelines on cervical cancer control are developed and disseminated, based on the natural history of the disease and data about the prevalence and incidence in different age groups;
- financial and technical resources are allocated to support the implementation of the policy and guidelines, making services accessible and affordable to women and girls;
- public education programmes and advocacy for prevention are in place to support the national policy;
- women and girls in the target age groups participate widely in screening and HPV vaccination;
- HPV vaccine is administered as a population-based strategy to adolescent girls between the ages of 9 and 13 years;
- screening is organized, rather than opportunistic;
- screening services are linked to treatment of pre-cancer and invasive cancer;
- a health management information system and a monitoring and evaluation plan are in place to monitor achievements, identify gaps and provide feedback regularly to managers and health-care providers, such that appropriate corrective action can be implemented in a timely manner;
- a functioning referral system is established and maintained; and
- an overall strengthened health system is in place.

⁹ Available at: <http://www.who.int/reproductivehealth/publications/cancers/9789241505260/en/>

Further reading

- Alliance for Cervical Cancer Prevention (ACCP). Planning and implementing cervical cancer prevention and control programs: a manual for managers. Seattle (WA): ACCP; 2004 (http://www.rho.org/files/ACCP_mfm.pdf, accessed 18 July 2014).
- Bray F, Znaor A, Cueva P, Korir A, Swaminathan R, Ullrich A, et al. Planning and developing population-based cancer registration in low- and middle-income settings. IARC Technical Publication No. 43. Lyon: International Agency for Research on Cancer; 2014 (<http://www.iarc.fr/en/publications/pdfs-online/treport-pub/treport-pub43/index.php>, accessed 16 June 2014).
- EngenderHealth. COPE® for cervical cancer prevention: a tool book to accompany the COPE® handbook. New York (NY): EngenderHealth; 2004 (http://screening.iarc.fr/doc/cope_cxca_toolbook.pdf, accessed 18 July 2014).
- Franco EL. Epidemiology in the study of cancer. In: Bertino JR, editor. Encyclopedia of cancer, volume 1. San Diego (CA): Academic Press; 1997:621–41.
- PATH. Implementing HPV vaccination programs: practical experience from PATH. Cervical cancer prevention: Practical experience series. Seattle (WA): PATH; 2011 (<http://www.rho.org/HPV-vaccine-implementation.htm>, accessed 18 July 2014).
- PATH. Strategic planning and situation assessment for cervical cancer prevention: practical experience from PATH. Cervical cancer prevention: practical experience series. Seattle (WA): PATH; 2011 (<http://www.rho.org/HPV-strategic-planning.htm>, accessed 18 July 2014).
- PATH. Cervical cancer prevention action planner, version 2.0 [website]. PATH; 2012 (<http://www.rho.org/actionplanner.htm>, accessed 18 July 2014).
- World Bank. World development indicators 2013. Washington (DC): World Bank; 2013 (<http://data.worldbank.org/products/wdi>, accessed 18 July 2014).

Useful websites:

EngenderHealth – Client-Oriented, Provider-Efficient Services (COPE®):

www.engenderhealth.org/our-work/improving-quality/cope.php

ExpandNet – Scaling up Health Innovations: www.expandnet.net/

International Agency for Research on Cancer (IARC) – Global Initiative for Cancer Registry Development (GICR): <http://gicr.iarc.fr>

United Nations Population Information Network: <http://www.un.org/popin/data.html>

WHO – The WHO Strategic Approach to strengthening sexual and reproductive health policies and programmes: www.who.int/reproductivehealth/topics/countries/strategic_approach/en/

WHO – HPV Vaccine Introduction Clearing House: www.who.int/immunization/hpv/en/



**CHAPTER 3. COMMUNITY
MOBILIZATION, EDUCATION
AND COUNSELLING**

Chapter 3. Community mobilization, education and counselling

Key points

- Outreach, community mobilization, health education and counselling are essential components of an effective cervical cancer prevention and control programme to ensure high vaccination coverage, high screening coverage and high adherence to treatment.
- Outreach strategies must reach and engage young girls and women who would most benefit from vaccination and screening, respectively, as well as men and boys and leaders in the community, and key stakeholders.
- Community mobilization and health education are essential tools for overcoming common challenges that impede access to and utilization of preventive care; these common barriers include social taboos, language barriers, lack of information and lack of transportation to service sites.
- Health education ensures that women, their families and the community at large understand that cervical cancer is preventable.
- Health education messages about cervical cancer should reflect the national policy and should be culturally appropriate and consistent at all levels of the health system.
- Health-care facilities should have a private room that can be used to provide individual women with information and counselling, if appropriate, to help them make the best choices for their health.
- Health-care providers should be trained to discuss sexuality in a nonjudgemental way and to address issues related to cervical cancer and human papillomavirus (HPV) while protecting patient privacy and confidentiality.
- It is critical that educational messages emphasize that women with abnormal screening results must return for follow-up.

About this chapter

This chapter is based on the following WHO guideline:

Cervical cancer, human papillomavirus (HPV), and HPV vaccines: key points for policy-makers and health professionals. Geneva: WHO; 2007 (http://whqlibdoc.who.int/hq/2008/WHO_RHR_08.14_eng.pdf).

Other articles and publications on which the chapter is based can be found under Further reading at the end of the chapter.

This chapter addresses the need to include outreach, community mobilization, health education and counselling in effective cervical cancer prevention and control programmes. The goal of these strategies is to motivate women and families to seek preventive services, including early detection and treatment of cervical pre-cancer and vaccination of girls, and ultimately to enable people to increase control over and improve their health.

This chapter consists of five main sections. Section 3.1, Increasing the use of cervical cancer prevention and control services, serves as an introduction to the subject of this chapter, with a focus on the central role of health-care providers. The remaining sections, on Outreach (section 3.2), Community mobilization (section 3.3), Preventive health education (section 3.4) and Counselling (section 3.5), provide information on the most effective approaches and key messages for each of these efforts, including helpful resources for implementing them. The transmission of consistent messages requires good communication skills and the use of nontechnical language appropriate to the target population.

The practice sheets for this chapter list the key messages to be included in health education about cervical cancer, provide answers to frequently asked questions (FAQs) about cervical cancer and HPV, give advice on how to involve men in preventing cervical cancer, and provide information on counselling. Some practice sheets for other chapters will also be of support to health-care providers on communication issues, and these will be referred to in this chapter.

3.1 Increasing the use of cervical cancer prevention and control services

Prevention saves lives and resources. The cost of losing a woman to cervical cancer is enormous, both for the family and the community. Good community outreach, education and counselling helps people to understand and reduce their personal risk of illness, and the risks to their family members and friends, by accepting and utilizing preventive care options such as vaccination and screening, avoiding harmful behaviours and adopting healthier lifestyles.

Many women and families may need support to overcome challenges that prevent them from receiving services. These challenges can range from fear of finding out they have an infection or disease, or shame about undergoing an exam of the genital organs, to confusion about the safety and effectiveness of the HPV vaccine, and/or lack of time or affordable transportation to reach the service facility. Community mobilization involves a process of working with the community to identify these challenges and develop strategies to overcome them.

Anna's story

Anna, a 32-year-old Kenyan woman, was not sick. In fact she was in high spirits. Shortly before, a community health worker's announcement at a funeral had inspired her. He had spoken about a disease that affects women – cancer of the cervix – and explained that the disease is preventable. If early cervical cancer is not detected and treated, a woman can die from the disease.

The community health worker, a person she knew and trusted, gave Anna a card and told her where she should go to have a screening test. "I felt it was important for me to find out if I had any risk because, after all, I could get help." When she returned two weeks later, she was told her test was negative, meaning it was normal. "I was greatly relieved," she said. Now, she only needs to return for another test in five years' time.

Because she was treated so kindly and learnt so much, Anna has begun to speak publicly about her experience. Many women she has spoken to have followed her advice and have been tested. Two of these women have reported to Anna that they were treated for pre-cancer so they would not get cancer. Anna is happy to be helping others: "I don't want anyone to die when there is an opportunity for us to live."

Source: Adapted from Women's stories, women's lives: experiences with cervical cancer screening and treatment. Seattle (WA): Alliance for Cervical Cancer Prevention; 2004.

3.1.1 The role of the health-care provider

Health-care providers play a central role in preventing and managing cervical cancer by increasing the use of vaccination and screening services by those who are most likely to benefit. The health-care providers who play this role could be doctors, nurses, trained midwives or community health workers – anyone who provides clinical or community services. These providers are key players on a larger team that together can compile and convey information about HPV infection and cervical cancer, how to prevent them, screen for them, and treat women with abnormal screening results. Experience has shown that direct communication between health-care providers and those seeking health services is the most effective method of sharing important health information and influencing health seeking behaviour. Individuals and families look to the provider for health information and services.

Using clear and sensitive language during interpersonal communications, conveying key messages that contain consistent and accurate information, and providing supportive woman-centred services that are conveniently accessible can make a difference in the success of efforts to reduce cervical cancer. See Box 3.1 for the characteristics of a health-care provider who can be a good health educator on the topic of cervical cancer.

Box 3.1: Characteristics and communication skills of an effective health educator on the topic of cervical cancer

- **Knowledgeable:** Have correct understanding about cervical cancer and how to prevent it, including the reasons for prioritizing particular age groups to receive services. Be able to anticipate and answer questions, and to seek further information as needed.
- **Comfortable with the topic:** Be comfortable talking about women's anatomy, sex and sexuality.
- **Clear and consistent:** Share key messages that are easy to understand and appropriate for your audience, and be consistent with these messages.
- **Sensitive and non-judgemental:** Issues related to sexual health can be very sensitive. Use appropriate language and tone. Ensure that the wording does not contribute to stigma or promote harmful gender stereotypes (see Table 3.1).
- **Supportive:** Be a good listener. Show patience and understanding and help women and families find solutions to their problems and make good decisions about getting the care they need.
- **Welcoming and encouraging:** When people feel welcome they are more likely to return for care when they need it.

3.2 Outreach

Outreach refers to the efforts made beyond the walls of the health-care facility to reach target populations with the goals of increasing knowledge about specific health issues (cervical cancer prevention is one example) and improving access to health services.

The role of the health-care provider includes outreach activities, which need to be carefully planned. The first step in developing an outreach plan is to identify the target population for the particular message, and to be able to clearly communicate the reasoning and importance of prioritizing that target group for the services. Refer to Figure 2.1 in Chapter 2, which identifies the age groups affected and those that can

benefit most from particular interventions. Working in partnership with the community creates support for prevention, which will facilitate reaching target populations. At the stage of planning outreach activities it is crucial to understand the key obstacles that may be preventing women and girls from receiving preventive health services.

The goal of outreach is to maximize coverage and utilization of cervical cancer prevention and control services. To achieve this there are five target or priority groups that need to be reached with messages relating to cervical cancer prevention:

- **Young adolescents (and their families):** Research indicates that the HPV vaccines are most effective if provided to girls and/or women prior to the onset of sexual activity and exposure to HPV infection; therefore, the target population for the HPV vaccine, as recommended by WHO, is young adolescent girls aged 9–13 years.¹ However, it is important to include boys in awareness and informational campaigns.
- **Adult women:** The greatest benefit from cervical screening can be gained by limiting the use of screening resources to women in the 30–49 age group, as recommended by WHO. This is because most women are infected with HPV in their teens and twenties and the virus normally takes 10–15 years to produce precancerous changes. Inclusion of family members and particularly male partners when conveying related health education messages is critical to ensuring acceptance of screening services.
- **Vulnerable groups:** Evidence shows that services tend to be used least by those most at risk. It is not enough to set up services and assume that girls and women who are at risk will arrive to make use of those services. Special efforts need to be made to reach the most vulnerable populations. These groups include:
 - girls who are hard to reach, especially those not attending formal education;
 - women who live far from services and have fewer resources;
 - migrant workers, refugees and other marginalized groups;
 - women and girls living with HIV and other immunosuppressed individuals who may require a more intensive screening schedule.
- **Community leaders and champions:** Engaging community leaders can greatly facilitate outreach efforts. A few strong leaders who become champions of the cause can bring in community support that will ensure a successful programme. Their contributions may include getting buy-in from local men, securing financial support for families in need, arranging transport to services or providing a venue for a talk or campaign event.
- **Men:** As with other aspects of women's reproductive health, it is crucial to reach and involve men. Men are often the “gatekeepers” of access to services for their

¹ Girls do not need to be asked about sexual activity before giving the vaccine. Asking such a young population about this gives the wrong message and can create fear and mistrust.

wives and daughters, so their support (or, in extreme cases, their permission) may be needed if women are to attend services. Increasing men's knowledge and understanding of women's health issues helps them make better health decisions for themselves and for their partners and helps build stronger programmes. Information about HPV and cervical cancer can be given to men in clinical and community settings with messages about the importance of encouraging their partners to be screened and treated when necessary (see Practice Sheet 3.3).



What men need to know

Once the target populations have been defined, an outreach plan can include:

- community health workers and peer-to-peer communication strategies to provide information and motivate populations to seek services;
- mobile screening units and/or vaccine brigades to bring services to communities;
- posters, pamphlets, radio, television and internet-based social media to reach all segments of the target populations, as well as people who can influence them.

See section 3.4.3(c) later in this chapter for more information about delivering health education in the community.

3.3 Community mobilization

Community mobilization is a process of engaging communities and generating support for all those in need of health services (for example, cervical cancer prevention and control), resulting in sustainable community ownership and participation.

Promotion of preventive services can be a challenge in any setting. People are often more likely to seek care if they or their family members are sick than to seek preventive services, and women often relegate their own preventive care to the lowest priority. Effective preventive care at health-care facilities requires not only setting up the service, but – equally important – engaging the community so that they understand and utilize it.

3.3.1 Engaging the community for prevention

Health-care providers are often overburdened with caring for patients, which makes it difficult to get out into the community. Community health workers, volunteers and facility managers can be mobilized to provide community education and outreach. Community partners – including community leaders, religious leaders, teachers and members of local women's groups – can all help to identify members of the target populations, and can also help to address barriers to access and treatment (see Box 3.2). Community mobilization efforts can expand the reach and impact of the limited resources of health centres and providers.

Box 3.2: Communities can make the difference

- More than 25 million families worldwide earn their living through coffee production. In many coffee-growing communities, small farmers have organized themselves into cooperatives, or unions, in order to share processing facilities and increase negotiating power. In Huatusco, Mexico, when coffee cooperative leaders learnt that many of the women in their community were dying needlessly of a preventable illness, they set to work to change the situation. Working with a nongovernmental organization and the Ministry of Health, they began by educating their members (mostly men) on the importance of saving women's lives and their role in giving their wives permission to be screened. They worked with the local health services to designate special days for screening "campaigns" and then used their coffee trucks to provide transport for the women. Family members helped out by taking over household chores and caring for small children.
- By making screening a special and visible event, it became acceptable for all women to attend. Women who were afraid were encouraged by their friends and neighbours to participate and, most importantly, women who tested positive were assured of treatment. For those women diagnosed with more advanced cancers, community funds were collected and support was given to the families to help them with what could be devastating costs. Within two years, more than 80% of women in the target age had been screened and 90% of those who screened positive had received treatment. The cooperative gained new members and their workers felt greater loyalty to the group. And of course, women's lives were saved.

3.3.2 Working with community health workers

Many health systems use trained community health workers (CHWs) to educate community members about prevention and to promote available health services. CHWs can serve as a bridge between health services and the community and are recognized worldwide as an essential part of any health-care team. Their peer-to-peer approach helps to gain the trust of families who can benefit from information and advice on both vaccination and screening programmes, addressing any fears or concerns that may be present. For example, when a woman is found to have a positive screening result, the CHW can explain the importance of returning to the clinic for further management; and if parents have concerns about the safety of the HPV vaccine, accurate information can help them to understand about the safety and benefits of the vaccine. Welcoming CHWs to accompany individual women when they attend services at a health centre or hospital, if the woman wishes it, can demonstrate to the community that CHWs are valued and knowledgeable team members.

When health-care providers have a good working relationship with CHWs, this can help facilitate:

- communities learning about cervical cancer prevention services, and their importance;
- families electing to have their daughters vaccinated, thus protecting more girls from infection with high-risk HPV types;
- women getting the support they need to make an informed decision about screening;
- eligible women in the community being screened and thus more cervical pre-cancers and cancers being detected early;
- women with positive results receiving treatment and care; and
- women who are referred for further care getting to those appointments.

If there is a group of community health workers or promoters already working on other health issues, it is best to incorporate cervical cancer information into their existing outreach work, by upgrading their knowledge on the issue. If CHWs do not exist in the community, community leaders and other stakeholders can assist in identifying and recruiting a group for training and service provision (see Practice Sheet 3.7).



PS3.7 CHWs

3.4 Preventive health education

Health education is an exchange of information with the purpose of increasing awareness and knowledge about how to keep healthy and prevent diseases (such as cervical cancer), including information about resources that are available and the benefits of accessing services.

3.4.1 Preventive education for individuals and communities

Many barriers to HPV vaccination and cervical cancer prevention and control programmes can be addressed by educating and engaging the community. Resistance to cancer screening may reflect lack of understanding that cervical cancer is preventable through screening and early treatment. It can also be difficult for women to put their own health first when they have so many competing demands on their time and resources. This situation can be exacerbated by gender bias, which can contribute to low uptake of prevention services for women and girls. In addition, community misunderstandings and concerns about vaccine programmes may create obstacles.

Quality health education involves communicating accurate information in simple, understandable language to individuals or groups with the goal of raising awareness, changing behaviour and reducing illness and deaths.

Health education is not a one-time event; it should be a continuous activity and requires constant effort to keep provider knowledge up to date. In cervical cancer prevention and control programmes, key health education objectives include:

- informing people about cervical cancer, its causes (especially HPV) and natural history;
- promoting HPV vaccines for girls, when they are available for that community;
- promoting screening for women in the eligible age group;
- ensuring that women who screen positive receive prompt treatment;
- increasing awareness of the signs and symptoms of cervical cancer and encouraging women to seek care if they have them; and
- addressing ignorance, fear, embarrassment and stigma related to HPV and cervical cancer.

3.4.2 How to provide health education

An effective health educator must have a strong knowledge base of relevant information, as well as comfort with the topic and sensitivity in choice of words. The characteristics and communication skills of an effective health educator on the topic of cervical cancer are detailed in Box 3.1 in section 3.1 of this chapter. But an effective health educator must also be proficient in presentation to ensure that his or her messages are fully understood and that participants remain engaged.

Some presentation tips:

- Give accurate information in a sensitive and nonjudgemental manner.
- Make sure the material is easy to understand and appropriate for the audience.
- Keep core messages consistent, regardless of the audience, but also strive to make messages both locally and culturally appropriate and tailor language to the audience using commonly understood terms whenever possible.
- Develop messages in accordance with national guidelines, but also use input from the community and pretest the draft messages and materials with people from the community; use their feedback and advice to revise the messages to ensure they will be fully understood and effective.
- Develop messages to address common fears and misconceptions, as well as the stigma sometimes attached to cancer and sexually transmitted infections (see section 3.4.4 and Table 3.1).
- Improve communication skills through practice. It's important to overcome any discomfort in talking about sexual matters or diseases that affect the genitals.

Box 3.3: Essential knowledge about cervical cancer

- WHAT is pre-cancer?
- WHAT is cervical cancer?
- HOW can cervical cancer be prevented?
- WHO should be vaccinated?
- WHO should be screened?
- WHICH prevention services are available locally?
- WHERE and WHEN can these local services be accessed?

Remember: Effective communication can increase rates of vaccination and screening, and save women's lives.

3.4.3 Developing and delivering an educational presentation on preventive health

In order to be most effective in outreach and education efforts it is important to understand the topic well and to have practice presenting the information. The fact that cervical cancer is linked to HPV, which is transmitted through sexual contact, raises some difficult questions that health-care providers need to be prepared to answer. Messages should be developed using nontechnical and culturally appropriate language.

a. Using key messages

Though cervical cancer prevention and control can be a complicated topic, the key messages can be kept short and simple to help people understand and make good choices.

Five key messages about the HPV vaccine:

1. There is a safe, effective vaccine that can protect against cervical cancer.
2. The HPV vaccine works best if received before sexual activity begins.
3. All girls in the age cohort or in the school class/grade/year identified as the target population by the national programme should receive the HPV vaccine.
4. HPV vaccines do not treat or get rid of existing HPV infections.
5. Girls who are already sexually active can also be given the HPV vaccine, though it may be less effective.

Five key messages about screening and treatment:

1. Cervical cancer is a disease that can be prevented.
2. There are tests to detect early changes in the cervix (known as pre-cancers) that may lead to cancer if not treated.
3. There are safe and effective treatments for these early changes.
4. All women aged 30–49 years should be screened for cervical cancer at least once.
5. No one needs to die from cervical cancer.

The specific messages developed for use in each country need to comply with the country's national guidelines, including the specified target populations (i.e. age ranges for vaccination of girls against HPV and for women's cervical cancer screening).

Practice Sheet 3.1 provides more detailed messages for use in health promotion and Practice Sheets 3.2 and 4.1 present answers to frequently asked questions (FAQs) about cervical cancer and the HPV vaccine, respectively. These resources can make the health educator's job easier; they can be modified to suit the needs of the provider as well as those of the local community.



Key messages



FAQs



HPV FAQs

b. Resources

To assist education efforts, additional materials and resources can be developed. Communication strategies and materials are most effective when they have been adapted or created with input from members of the target audience.

Consider using the following tools and resources:

- **Flipcharts** are especially good for group education sessions. Pictures should be easy to see and understand. Telling a story of a woman going for screening and getting treatment can be more effective and easier to understand than complicated pictures of anatomy and viruses.
- **Brochures** can give simple information and prevention messages for community members to take home and discuss with their families and others.
- **Drama and role-playing** can occur in marketplaces or at community meetings and can capture people's attention and teach through storytelling. Peer experiences can be used either in live events or as case studies for drama and role-playing.

- **Radio and video programmes** are effective for telling stories and for transmitting short messages or announcements. Taking part as a guest on a radio or television talk programme enables the presentation of a lot of information to reach many people at once. Local radio stations are particularly useful for announcing services and campaigns and reminding the untreated screen-positive women to return for treatment.

c. Delivering health education

In health-care facilities

Whenever possible, cervical cancer education (including information on HPV vaccination and screening) should be made available when women arrive at a health-care facility for any service, either for themselves or for a family member. Information can be provided to groups in waiting areas through posters, health talks, videos and/or written materials. Information and education on prevention of cervical cancer can be provided to more men and women by integrating it into health talks on antenatal and postnatal care, family planning, care for chronic illnesses, and sexually transmitted infections (STIs), including HIV/AIDS.

In the community

Community education may take place in a variety of settings, such as community centres, places of worship and schools, at sports activities, on local health awareness days, or in the context of a screening campaign. Selected members of the community can be trained to deliver key messages: medical professionals, teachers, community leaders, community health workers, traditional healers and midwives. Messages about the benefits of the HPV vaccine (if it is available) should be tailored for girls, boys and their parents or guardians, while messages about the benefits of screening should be targeted at women and their partners.

Examples of community outreach activities include:

- **Community health education:** Information sessions organized by health-care providers or trained CHWs can increase utilization of cervical cancer prevention and control services. These are also very popular if they are done well and provided in locations where women congregate or wait in a line (queue) for any reason (e.g. food aid, school registration, etc.).
- **Home visits:** CHWs or other community or social workers can provide information about preventive health services, address concerns and questions, and assist women in making arrangements to attend the health-care facility. If a male partner and/or other family members are present, and all present agree, they can be included in the discussion.

- **Client word of mouth:** Satisfied clients can be encouraged to discuss HPV vaccination and cervical cancer screening with their friends and family members. A brochure can serve as a visual aid.
- **Community cultural activities:** Information tables and/or announcements at community events, fairs or festivals are useful opportunities to present messages to the wider community. Market days, too, where both the merchants and buyers are predominantly women, lend themselves to community education.

3.4.4 Managing misinformation and preventing stigma in health education on HPV and cancer

Stigma relating to HPV and cancer can interfere with access to care and treatment. Often there is stigma related to diseases of the reproductive tract, particularly STIs, including HPV. Parents may be concerned about vaccinating their daughters with a new vaccine. Women may fear that screening will be painful and may be embarrassed about genital examinations, as well as having concerns about lack of privacy and confidentiality, which may keep them from attending services.

Educating parents on the safety of the vaccine and its effectiveness in protecting their daughters from cervical cancer in the future reduces concerns. Educating a woman privately about what is involved in screening and reassuring her that the screening procedure is safe and painless is a key way of addressing any fears and misconceptions. If such information is followed by skilful, respectful provision of services, women and their families will be more likely to utilize prevention services and will be more likely to recommend vaccination and screening to their friends and family.

Health-care providers play an important role in preventing misinformation and stigma about cervical cancer prevention. Review the messages in Table 3.1, and talk to co-workers and community members about common local misconceptions and how to share information about cervical cancer prevention in a way that does not create stigma or fear. Also see Practice Sheet 3.1 for key messages and Practice Sheet 3.2 for answers to FAQs about cervical cancer.



Key messages



FAQs

Table 3.1: Messages about cervical cancer screening that can cause stigma, and suggestions for better messages

Messages that may cause problems	Unintended results	Better to say
<p>Message that can create stigma: Cervical cancer is caused by HPV, which is a sexually transmitted infection (STI). Women who have cervical cancer or pre-cancer have an STI.</p>	<p>Talking about cervical cancer and pre-cancer as a STI may create stigma for the screening programme and for women who test positive and receive treatment. It may make women less willing to be tested and may cause problems in her relationship with her partner, including causing gender-based violence.</p>	<ul style="list-style-type: none"> • Cervical cancer is caused by a virus called HPV that is passed through sexual contact and most people get it at some time in their life. • Most HPV infections go away on their own without the person knowing they were infected. • In some women, the infection does not go away and after years may cause a precancerous lesion. If not detected and treated, it can develop into cervical cancer. • All women should be screened for cervical cancer at least once between the ages of 30 and 49 years, or in accordance with national guidelines. • Women living with HIV are at higher risk for cervical cancer. They should be screened as soon as they are diagnosed with HIV.

Messages that may cause problems	Unintended results	Better to say
Inaccurate information: Screening is a test for cervical cancer.	When it is labelled a test for cervical cancer, it is logical for people to think that a positive test means that a woman has cancer. This creates great stress and fear.	<ul style="list-style-type: none"> • Screening uses a simple test (Pap smear, VIA or an HPV test) to detect very early changes in the cervix (also called pre-cancer), before cancer develops.
Misinformation: There is no point in going for cervical cancer screening. If a woman tests positive, it means she has a fatal condition and she will die.	Few women will go for a screening test if they don't think there is a solution.	<ul style="list-style-type: none"> • Cervical cancer can be prevented when early changes in the cervix, called pre-cancer (lesions that may become cancer), are found using a simple test. • If a woman has these early changes, there is safe and simple treatment that she can receive. • If women are screened at the right ages, between 30 and 49 years, then cervical cancer can be prevented. • Cervical cancer, if detected early, can be cured.
Misinformation: Intrauterine devices (IUDs) and birth control pills cause cervical cancer.	Women will be afraid to use contraception, even though this is not true.	<ul style="list-style-type: none"> • IUDs do not increase a woman's risk of cervical cancer. Birth control pills can cause a very slight increase in risk, but the benefits of preventing pregnancy are much greater than the very small increased risk of developing cervical cancer.

continued next page

Messages that may cause problems	Unintended results	Better to say
<p>Misinformation: The screening test is painful and a part of a woman's body is removed.</p>	<p>Women will be afraid to go for a screening test. Her family might be afraid and stop her from going.</p>	<ul style="list-style-type: none"> • The speculum examination may make some women uncomfortable but the test is not painful. • During the test, a soft swab or brush gently touches a woman's cervix. • The test is simple and just takes a few minutes. • Screening is not the same as taking a biopsy or having surgery. There is no cutting involved in screening tests.

3.4.5 Educational information about the HPV vaccine

As with any new health-care product or service, there will be some questions, fears and misconceptions related to the HPV vaccine. Naturally, families want to know about vaccine safety, how well it works, how long it will protect and whether there are any common adverse reactions or events. Such concerns can be addressed by raising awareness about vaccination, using examples of childhood immunizations that also need multiple doses to provide full protection.

Experiences in a number of countries have shown that, when promoting the HPV vaccine, informational messages should not overemphasize that the vaccine prevents an STI; rather, they have found that it is more relevant and more effective to focus on the potential of the vaccine to prevent cancer.

Providing some details about the testing of the vaccines in clinical trials and their excellent safety record will encourage parents to make sure that their daughters receive the vaccine and adhere to the recommended schedule. For community leaders, printed materials about cervical cancer and HPV vaccines are useful in helping them respond to questions from their constituents. Some common misconceptions and key facts about the HPV vaccine are presented in Table 3.2. Complete information on HPV vaccination can be found in Chapter 4 and its practice sheets.

Table 3.2: Misconceptions and facts about the HPV vaccine

Misconceptions found in communities	Facts (based on evidence from large studies)
The vaccine might be dangerous.	The safety of the HPV vaccine has been carefully evaluated since 2002, and is similar to that of other vaccines in wide use internationally (for more details, see Chapter 4).
The vaccine affects fertility and if given to young girls might make them infertile.	The HPV vaccine does not cause infertility or sterility.
My daughter does not need this vaccination now because she is so young and not yet sexually active.	It is important to protect girls before they are sexually active.
This vaccine will promote earlier sexual activity.	The evidence suggests that being vaccinated against HPV has no impact on the age people become sexually active.

3.5 Counselling

Counselling refers to advice or guidance (usually one-on-one) from a knowledgeable person to facilitate personal decision-making. Counselling is generally conducted privately and confidentially. Counselling requires good listening and communication skills as well as knowledge of the subject being discussed. A good counsellor uses verbal and nonverbal communication skills and helps the client feel at ease by empathizing with her situation, reassuring her, and fostering a sense of partnership in addressing her problem.

Providers involved in cervical cancer control at all levels should be trained in basic counselling skills so that they can communicate effectively with clients (see Practice Sheet 3.4).



Counselling

The content of the counselling encounter will vary according to the client's problems or concerns and her individual circumstances. It can cover prevention, screening, follow-up, referral, diagnosis, treatment of precancerous lesions, treatment of invasive cancer and/or palliative care. The chapters and practice sheets that provide more specific information on how to talk with a woman under each of these circumstances are indicated in the relevant sub-sections in the remainder of this chapter.

3.5.1 Who needs counselling?

All women and men who need to make a decision about their health and whether to have a service, medication or treatment may benefit from counselling that includes provision of correct information and a two-way private conversation about the available options, including how the choice to receive or decline a service (e.g. a screening test) might affect her or his present and future health. See Practice Sheet 3.5 for standard counselling steps for before, during and after a client has a test, procedure or treatment.



Counselling steps

Girls and their parents can be counselled together or individually about HPV vaccination. Joint counselling provides an opportunity to have a conversation about sexual health with girls and to encourage cervical cancer screening for their mothers. See Practice Sheet 4.1 for answers to FAQs about HPV vaccination.



HPV FAQs

Women and girls who are living with HIV need to receive information and counselling about their greater vulnerability to HPV infection and their increased likelihood of developing cervical cancer at an earlier age. Women and girls living with HIV should be counselled to start regular screening as soon as possible after they learn of their positive status and to promptly receive treatment for any abnormality found. See Practice Sheet 3.6 on counselling for women living with HIV, and see Chapter 5 for further information on screening for women living with HIV, in section 5.2.5(a), and on diagnostic procedures for women living with HIV, in section 5.4.6(c).



HIV Counselling

Every woman who tests positive on a cervical screening test for precancerous lesions will need counselling. Ensuring treatment and preventing loss to follow-up may be the most important component of a successful screening effort (see the next section in this chapter, and see Practice Sheet 5.7 in Chapter 5 for how to counsel a patient after a positive screening result).



Counselling: +ve

Counselling should be structured to:

- educate the woman about the natural history of HPV infection and cervical cancer;
- review and explain the screening results and the importance of follow-up care and treatment, if required;
- present alternative services and procedures; and
- answer all of the client's questions and concerns with appropriate information. It is also fine to acknowledge that you don't have immediate answers to all questions

and to say that you will find the correct information and either contact her directly with the information or find another provider who can do this.

3.5.2 Key components of counselling for women with positive results on a test or examination and for women with cervical cancer

Be sure to include the following in the counselling:

If a client had a positive screening test and is eligible for cryotherapy or LEEP:

- Does she understand the purpose of the screening test and the possibility of preventing cancer through early treatment?
- Does she understand that a positive test probably means that she has early cell changes, and only rarely does it mean she has cancer?
- Is there any reason she may have difficulty returning for care, such as an unsupportive or opposing partner, lack of transport, or financial difficulties? If so, discuss possible solutions and help her make a plan to obtain the services she needs.

If a client's examination was suspicious for cancer:

- Ask her if she has someone with her today that she would like to have present for the discussion.
- Express concern about the seriousness of the findings, but do NOT tell her she has cancer as it is too early at this point to be sure of that diagnosis. Do tell her that she had a positive screening test and that she needs to be referred for further testing/evaluation.
- Do reassure her that she will receive the help she needs.
- Provide her with clear information about where to go for diagnosis and treatment.
- Invite her to return with any questions she may have.

For more information on counselling for screen-positive women when the results are suspicious for cancer and when they are not suspicious for cancer, see Practice Sheet 5.7.



Counselling: +ve

If a client had a definitive diagnosis of cancer:

- Ask her if she has someone with her today that she would like to have present for the discussion.
- Express concern about the findings, but reassure her that most cases of cervical cancer can be successfully treated when found early enough.

- Describe the nature and the course of her disease and discuss the prospect of treatment and the chances of cure. In every situation, be sure that the information given is correct and understood.
- Ask questions to test the client's understanding and take the time to answer any questions or address confusion.

See Practice Sheet 6.2 for more information on counselling after a diagnosis of cancer, and Practice Sheet 6.4 (for cancer specialists) on talking to a patient about her cancer and treatment. Also see Chapter 6, section 6.6.1 for counselling guidance related to managing cervical cancer in pregnant women.



Counselling:
Cancer diagnosis



Cancer specialists

If a client is diagnosed with invasive cervical cancer and her case is beyond cure:

- Provide empathetic counselling and support. She will need information and psychological and spiritual support as well as arrangements for palliative care to alleviate pain and keep her as comfortable as possible.
- Such counselling may involve only the patient or also her partner and other family members, especially if decisions concerning severe disease or costly treatment need to be made.

In Chapter 7, see section 7.5 on keeping the patient and her support circle informed, and Practice Sheet 7.3 for further guidance on having a conversation with a patient who is returning home under palliative care.



Counselling:
Palliative care

For more complete information:

- on cervical cancer screening and treatment, see Chapter 5
- on treatment of invasive cancer, see Chapter 6
- on palliative care, see Chapter 7.

Further reading

- Alliance for Cervical Cancer Prevention (ACCP). Planning and implementing cervical cancer prevention and control programmes: a manual for managers. Seattle (WA): ACCP; 2004 (http://www.rho.org/files/ACCP_mfm.pdf, accessed 18 July 2014).
- Alliance for Cervical Cancer Prevention (ACCP). Women's stories, women's lives: experiences with cervical cancer screening and treatment. Seattle (WA): ACCP; 2004 (http://www.path.org/publications/files/RH_womens_stories.pdf, accessed 18 July 2014).
- Bradley J, Lynam PF, Dwyer JC, Wambwa GE. Whole-site training: a new approach to the organization of training. AVSC Working Paper, No. 11. New York (NY): Association for Voluntary Surgical Contraception; 1998 (http://www.engenderhealth.org/pubs/workpap/wp11/wp_11.html, accessed 18 July 2014).
- Burns AA, Lovich R, Maxwell J, Shapiro K, Niemann S, Metcalf E, editors. Where women have no doctor: a health guide for women. Berkeley (CA): Hesperian Foundation; 2010.
- Herman Z. Community health guides: making materials relevant, effective, and empowering. Washington (DC): United States Agency for International Development, Health Care Improvement Project; 2012.
- Hubley J. Communicating health: an action guide to health education and health promotion. London: Macmillan; 1993.
- Kirby D, Laris BA, Roller LA. Sex and HIV education programs: their impact on sexual behaviors of young people throughout the world. *J Adolesc Health*. 2007;40(3):206–17. doi:10.1016/j.jadohealth.2006.11.143.
- Luciani S, Winkler J. Cervical cancer prevention in Peru: lessons learned from the TATI Demonstration Project. Washington (DC): Pan American Health Organization (PAHO); 2006 (<http://screening.iarc.fr/doc/pcc-cc-tati-rpt.pdf>, accessed 18 July 2014).
- PATH. Implementing HPV vaccination programs: practical experience from PATH. Cervical cancer prevention: practical experience series. Seattle (WA): PATH; 2011 (http://www.rho.org/files/rb2/Implementing_HPV_vaccination_PATH_2011.pdf, accessed 18 July 2014).
- PATH. Conducting formative research for HPV vaccination program planning: practical experience from PATH. Cervical cancer prevention: practical experience series. Seattle (WA): PATH; 2012 (http://www.rho.org/files/PATH_HPV-conducting-formative-research_2012.pdf, accessed 18 July 2014).

- Promundo, CulturaSalud, REDMAS. Program P: a manual for engaging men in fatherhood, caregiving and maternal and child health. Rio de Janeiro, Brazil and Washington (DC): Promundo; 2013 (<http://men-care.org/data/FInal%20Program%20P%20-%20Single%20Page.pdf>, accessed 18 July 2014).
- Rinehart W, Rudy S, Drennan M. GATHER guide to counselling. Population Reports, Series J, No. 48. Baltimore (MD): Johns Hopkins School of Public Health, Population Information Program; 1998 (http://pdf.usaid.gov/pdf_docs/Pnacp920.pdf, accessed 18 July 2014).
- United Nations Educational, Scientific and Cultural Organization (UNESCO). International technical guidance on sexuality education: an evidence-informed approach for schools, teachers and health educators. Volume I: the rationale for sexuality education. Paris: UNESCO; 2009 (<http://unesdoc.unesco.org/images/0018/001832/183281e.pdf>, accessed 18 July 2014).
- Younger E, Wittet S, Hooks C, Lasher H. Immunization and child health materials development guide. Seattle (WA): PATH, Bill and Melinda Gates Children's Vaccine Program; 2001 (http://www.rho.org/files/rb3/Immunization_Child_Health_Materials_Development_Guide_PATH_2001.pdf, accessed 18 July 2014).



**CHAPTER 4.
HPV VACCINATION**

Chapter 4. HPV vaccination

Key points

- Human papillomavirus (HPV) is the most common sexually transmitted infection (STI).
- Cervical cancer is caused by high-risk types of HPV; the two high-risk HPV types that most commonly cause cervical cancer are types 16 and 18, which together are responsible for approximately 70% of cervical cancer cases in all countries around the world.
- Two vaccines that prevent infections from high-risk HPV types 16 and 18 are presently licensed in most countries; they both have excellent safety records and may be safely co-administered with other vaccines, such as those for diphtheria, tetanus and pertussis (DTP) and hepatitis B.
- One of the HPV vaccines, the quadrivalent vaccine, also prevents infections from HPV types 6 and 11, which cause 90% of anogenital warts or condyloma.
- Vaccinating girls before initiation of sexual activity is an important primary prevention intervention in a comprehensive cervical cancer prevention and control programme.
- The vaccines do not treat pre-existing HPV infection or HPV-associated disease, which is why vaccination is recommended prior to initiation of sexual activity.
- Because the vaccines do not protect against all HPV types that can cause cervical cancer, girls vaccinated against HPV will still require cervical cancer screening later in their lives.

Key WHO Recommendations on HPV vaccines

- Countries should consider introducing HPV vaccination when: (i) cervical cancer or other HPV-related diseases, or both, constitute a public health priority; (ii) vaccine introduction is programmatically feasible; (iii) sustainable financing can be secured; and (iv) the cost-effectiveness of vaccination strategies in the country or region has been considered.
- HPV vaccination should be introduced as part of a coordinated comprehensive strategy to prevent cervical cancer and other HPV-related diseases. The introduction of HPV vaccination should not undermine or divert funding from the development or maintenance of effective screening programmes for cervical cancer.
- WHO recommends the HPV vaccine for girls in the age group of 9–13 years. Girls receiving a first dose of HPV vaccine before the age of 15 years can use a two-dose schedule. The interval between the two doses should be six months. There is no maximum interval between the two doses; however, an interval of no greater than 12–15 months is suggested. If the interval between doses is shorter than five months, then a third dose should be given at least six months after the first dose. Immunocompromised individuals, including those who are living with HIV, and females aged 15 years and older should also receive the vaccine and need three doses (at 0, 1–2, and 6 months schedule) to be fully protected.

Source: World Health Organization (WHO). Human papillomavirus vaccines: WHO position paper, October 2014. *Wkly Epidemiol Rec.* 2014; 89(43):465–92 (<http://www.who.int/wer/2014/wer8943.pdf>).

About this chapter

This chapter is based on the following WHO guidelines:

Human papillomavirus vaccines: WHO position paper, October 2014. *Wkly Epidemiol Rec.* 2014; 89(43):465–92 (<http://www.who.int/wer/2014/wer8943.pdf>).

Meeting of the Strategic Advisory Group of Experts on immunization, April 2014 – conclusions and recommendations. *Wkly Epidemiol Rec.* 2014;89(21):221–36 (<http://www.who.int/wer/2014/wer8921.pdf>).

New vaccine post-introduction evaluation (PIE) tool. Geneva: WHO; 2010 (WHO/IVB/10.03; http://www.who.int/immunization/monitoring_surveillance/resources/PIE_tool/en/).

WHO guidance note: comprehensive cervical cancer prevention and control: a healthier future for girls and women. Geneva: WHO; 2013 (<http://www.who.int/reproductivehealth/publications/cancers/9789241505147/en/>).

WHO information sheet: observed rate of vaccine reactions: human papillomavirus vaccine. Geneva: WHO; 2012 (http://www.who.int/vaccine_safety/initiative/tools/HPV_Vaccine_rates_information_sheet.pdf).

WHO–UNICEF guidelines for developing a comprehensive MultiYear Plan (cMYP). Geneva: WHO; 2014 (http://www.who.int/immunization/documents/control/WHO_IVB_14.01/en/).

The WHO–UNICEF joint statement: vaccine donations, August 7, 2010. Geneva: WHO; 2010 (http://whqlibdoc.who.int/hq/2010/WHO_IVB_10.09_eng.pdf).

The practice sheets for this chapter cover the details of many aspects of HPV vaccination programmes, including answers to frequently asked questions, vaccine characteristics and the cold chain, preparation and implementation of an immunization session, injection safety, programme monitoring and evaluation, adverse events and talking with teachers and school officials about school-based vaccination sessions.

Mariel's story

Mariel is 35 years old and she has two daughters: Annie, age 7, and Rose, age 10. Mariel's mother died five years ago of cervical cancer at age 60. Her mother's last two years of life were miserable despite help she received from her family after she was discharged from the hospital. Hospital treatment had not been successful and she was in constant need of pain medication and had developed a foul-smelling discharge from her vagina. After seeing how her mother suffered and with assistance from her community health worker, Mariel has had two cervical screening tests in the last six years, both negative.

A month ago, the community health worker came to visit Mariel and her partner and informed them that a new programme related to cervical cancer prevention was going to start in their community, including vaccinations against cervical cancer available for all girls aged 9–13 years. She also informed them that for the vaccine to work, it has to be given when a girl had not yet become sexually active. Mariel had already learnt a great deal about this vaccine when she attended a meeting about it in a nearby community; she had later discussed what she had learnt with her family and they all thought it was a great idea to have Rose vaccinated. The community health worker invited them to come a similar informational meeting in their community for all parents of girls aged 9–13 years, and other interested people. The meeting in three weeks' time would provide complete information and an opportunity to get answers to any questions. The programme staff would also schedule the vaccination days to be convenient for most girls and their parents.

Mariel and her partner told the community health worker that not only did they plan to attend the meeting, but they would also volunteer to visit and encourage other families to attend. Furthermore, Mariel would be happy to support the providers conducting the meeting by presenting the story of her mother's suffering caused by cervical cancer, and by encouraging the participants to have their daughters vaccinated to reduce their chances of getting the disease when they become mature women.

4.1 Roles of health-care providers and others

Community health workers and primary- and secondary-level health-care providers and their teams are the implementers of vaccination programmes at the central and regional levels. See Practice Sheet 4.1 for answers to frequently asked questions about HPV vaccination.



Community health workers

Community health workers (CHWs) are in constant contact and communication with families in their communities and they are the bridge between the community and the facility-based health-care providers.

In an HPV vaccination programme, their role may include:

1. raising awareness about the availability of the HPV vaccine and its importance for preventing cervical cancer, targeting the community at large, local health and community managers, local authorities, religious leaders and civil society representatives;
2. educating girls and their parents and other community members about the benefits of the HPV vaccine and other available cervical cancer prevention strategies;
3. countering misinformation and rumours that undermine acceptance of vaccination, by providing accurate information;
4. obtaining informed consent from parents;
5. facilitating girls' attendance at vaccine sites;
6. reminding girls and their families to get the subsequent dose(s) needed for full protection (see dosing schedule in section 4.2.3);
7. vaccinating girls, either in the community, at schools or other selected venues, and/or documenting vaccination-related activities; and
8. facilitating or assisting in the delivery of additional interventions that the country may have selected to improve the health of adolescent girls and boys (e.g. delivering other vaccines or deworming medication).

Primary- and secondary-level health-care providers: nurses, doctors, vaccinators

Because of the many unique features of HPV vaccines, including the target population of girls aged 9–13 years, these providers, once trained, play important roles beyond the administration of vaccines. Teamed up with teachers, school officials, local volunteers, private health-care providers and other support people, their responsibilities may additionally include:

- 1–4. the first four responsibilities listed under CHWs' roles above; plus
5. training and educating teachers and other school officials to enable them to educate girls and to facilitate school-based vaccination sessions;
6. vaccine management and delivery;
7. maintaining meticulous records of girls vaccinated, their age and vaccine dose; and
8. facilitating or assisting in the delivery of additional interventions that the country may have selected to improve the health of adolescent girls and boys (e.g. delivering other vaccines or deworming medication).

See Practice Sheets 4.3–4.5 for more information.



Immunization session



Injection safety



M & E

Teachers and school officials

These individuals may play additional dedicated roles in school-based vaccination strategies. After receiving training, teachers can educate students and their parents about the benefits of vaccination, dispel any rumours and myths surrounding the vaccine, and answer other questions and concerns prior to the vaccination day. See Chapter 3 for guidance on communication approaches, and Practice Sheet 4.7 on talking with teachers and school officials about HPV vaccination.



Teachers and schools

On the day of the vaccinations, school staff can assist the vaccine delivery team to ensure eligible girls are vaccinated, identify eligible girls who are absent on that day, and facilitate other logistical issues as appropriate (for further details about the immunization session, refer to Practice Sheet 4.3).



Immunization session

Integrated approaches

HPV vaccine introduction may also provide the impetus and opportunity to improve, strengthen and integrate other health-care interventions for 9- to 13-year-olds at national, regional and local/school levels. For example, health-care providers and community health workers involved in HPV vaccination programmes could facilitate access to other health services for this age group, and vaccine introduction may also serve as an opportunity to improve and facilitate adolescent health education.

4.2 HPV vaccines

Currently, two HPV vaccines providing protection against high-risk HPV types 16 and 18 have been licensed, and one or both of them are available in most countries:

- the bivalent vaccine (protection against types 16 and 18 only)
- the quadrivalent vaccine (contains additional protection against types 6 and 11, which are responsible for 90% of benign anogenital warts or condyloma).

Both vaccines contain virus-like particles (VLPs), which are pieces shaped like the outside of a human papillomavirus. Because these VLP vaccines contain no virus, they CANNOT cause an HPV infection. The vaccines stimulate development of antibodies against these VLPs, which, due to the similarity with HPV viruses, will prevent HPV infection in case of later exposure.

The vaccines should be given BEFORE a girl has become infected with HPV. A girl can become infected with HPV soon after she becomes sexually active, so, as an important primary prevention intervention against cervical cancer, HPV vaccination of girls should occur prior to onset of sexual activity.

The vaccines do not treat existing HPV infection or HPV-related disease, nor do they have any effect on the progression of disease (pre-cancer and cancer) if given to women who are already infected with HPV at the time of vaccination.

4.2.1 Protective effects of the vaccines: available evidence and gaps in knowledge

Several studies were conducted pre-licensure with large numbers of girls and young women in the United States of America and in European countries and some middle-income countries. The studies had the objectives of determining the effectiveness of the vaccines and the duration of the protective effect against cervical cancer and, in the case of the quadrivalent vaccine, against genital warts. Before receiving the vaccines, the girls and women who participated in the studies were educated about the studies, and provided informed consent.

Following are the key study results regarding the strength and duration of protection provided by HPV vaccines:

- Both vaccines produced very high levels of protection against pre-cancer caused by HPV types 16 and 18 in 93–99% of participating girls and women, which will result in significant reduction of new cases of invasive cancer in the future.
- The HPV vaccines produce an antibody response much higher than the antibody response produced by natural infection.
- The protection reduced both initial and persistent HPV infections, and also protected against moderate and severe pre-cancer (i.e. CIN2+).

- The quadrivalent vaccine was also shown to greatly reduce the rate of genital warts.
- Results also indicate that the quantity of antibodies produced after HPV vaccination is greater in girls below the age of 15 than in girls and women aged 15 years and older.
- Some follow-up studies to determine the exact duration of protection induced by complete vaccination are still ongoing. But it is reassuring that at approximately 10 years post-vaccination, which is the length of follow-up we have to date, there has been no decreased immunity in women who received the vaccine. Based on this finding, there is currently no recommendation for booster doses.

Gaps in knowledge about the protective effect of HPV vaccines:

- Although preliminary findings indicate that, in addition to protection from HPV types 16 and 18, there is some cross-protection to other cancer-causing virus types, the strength and duration of this protection are still uncertain.
- HPV vaccination has not been tested in children under 9 years of age, therefore the vaccines are not currently licensed or recommended for girls under age 9.
- The duration and degree of protection in girls and women with HIV are still under study.

4.2.2 Safety, adverse events and contraindications

The results of studies indicate the following about the safety of HPV vaccines and the potential adverse events:

- Both vaccines have been well tolerated and neither has given reason for any major safety concern. This is after more than 175 million doses have been administered worldwide.
- In studies conducted in the United States, the most common complaints from vaccinated girls were pain and swelling at the injection site.
- Post-marketing data (i.e. after vaccines were licensed and used) from studies worldwide have not identified any health risks other than mild adverse reactions, such as fever, dizziness and nausea.
- Fainting has been reported after HPV vaccine administration; fainting is common in adolescents after many procedures that cause anxiety or very minimal pain. For this reason, it is recommended that girls should be seated and observed during and 15 minutes after HPV vaccine administration.
- Serious adverse events are extremely rare. Anaphylaxis can be causally related to HPV vaccination and precautions should be taken to avoid vaccinating girls with subsequent HPV vaccine doses and with other vaccines that contain similar vaccine components. If anaphylaxis is suspected, the girl should immediately be treated as needed.

Contraindications to HPV vaccines:

- HPV vaccines should not be given to anybody who has experienced severe allergic reactions after a previous dose of the vaccine or after exposure to one of its components (e.g. yeast). Symptoms of an allergic reaction may include: itching, rash, urticaria or blisters. If any of these symptoms occurs post-HPV-vaccination, no more doses should be given, and other vaccines that may have these same components included in them should be avoided.
- Girls with severe febrile illness should not be vaccinated.
- HPV vaccines are not currently recommended for use in women who are pregnant. Given that HPV vaccines are recommended for girls aged 9–13 years, the likelihood of a girl being pregnant or breastfeeding at the time of vaccination is low. If a girl becomes pregnant after initiating the vaccination series, the remainder of the regime should be delayed until after the pregnancy. In the event that the HPV vaccine is inadvertently administered to a girl or woman who is pregnant, no intervention is necessary. She should be reassured that the vaccine does NOT contain live virus, and that no health problems in mother or child have been observed to date after accidental HPV vaccination during pregnancy. The remaining vaccine dose(s) should be postponed until after the pregnancy, at which time the HPV vaccine series can be completed. It is NOT necessary to restart the vaccine series after the pregnancy. In case of the HPV vaccine being given to someone who is breastfeeding, available data do not indicate any safety concerns.

Further information can be found in WHO information sheet: observed rate of vaccine reactions: human papillomavirus vaccine (June 2012)¹. The latest data on the safety of the HPV vaccine can be found on the website of the Global Advisory Committee on Vaccine Safety (GACVS)².

4.2.3 Vaccine characteristics and schedules

Table 4.1 summarizes and contrasts the characteristics and vaccination schedules for the two available vaccines (administration and schedules based on current WHO recommendations).

The recommended target population for HPV vaccination are girls aged 9–13 years, prior to initiation of sexual activity.

¹ Available at:

http://www.who.int/vaccine_safety/initiative/tools/HPV_Vaccine_rates_information_sheet.pdf

² Available at: http://www.who.int/vaccine_safety/committee/topics/hpv/en/

Table 4.1: Characteristics of HPV vaccines

Attributes	Quadrivalent	Bivalent
Commercial name (manufacturer) (see note 1)	Gardasil® Silgard® (Merck)	Cervarix® (GlaxoSmithKline)
HPV types in vaccine	6, 11, 16, 18	16, 18
Disease protection	cervical cancer genital warts	cervical cancer
Number of doses (see note 2 below)	2 doses, the second dose 6 months after the first dose	2 doses, the second dose 6 months after the first dose
Duration of protection	no decrease in protection noted during the period of observation	no decrease in protection noted during the period of observation
Presentation	1-dose vial	1- and 2-dose vials
Method of administration	intramuscular injection: 0.5 ml of liquid suspension	intramuscular injection: 0.5 ml of liquid suspension
Contraindications (see section 4.2.2)	<ul style="list-style-type: none"> severe allergic reaction to any vaccine component or after receiving the vaccine severe febrile illness not recommended during pregnancy 	<ul style="list-style-type: none"> severe allergic reaction to any vaccine component or after receiving the vaccine severe febrile illness not recommended during pregnancy
Co-administration with other adolescent vaccines studied and found to be effective (see note 3 below)	hepatitis B diphtheria/tetanus/ pertussis poliomyelitis	diphtheria/tetanus/ pertussis poliomyelitis
Shelf life (see note 4 below)	36 months at 2–8°C	1-dose vial: 48 months at 2–8°C 2-dose vial: 36 months at 2–8°C

Important notes on vaccine characteristics and schedules:

1. Data are not available on the safety, immunogenicity or efficacy of the two marketed HPV vaccines when used interchangeably. These vaccines have different characteristics, components and indications, and in settings where both vaccines are available, every effort should be taken to administer the same vaccine for all required doses. However, if the vaccine used for a prior dose is unknown or unavailable, either of the marketed HPV vaccines can be administered to complete the missing dose or doses.
2. As per the WHO Position Paper (October 2014), the recommended target population are girls aged 9–13 years, prior to initiation of sexual activity. A two-dose schedule with an interval of six months between doses for girls aged < 15 years (including those girls aged ≥ 15 years at the time of the second dose). There is no maximum interval between the two doses; however, an interval of not greater than 12–15 months is suggested. If for any reason the interval between the two doses is shorter than five months, then a third dose should be given at least six months after the first dose. The three-dose schedule (0, 1–2, 6 months) remains recommended for girls aged 15 years and older and for immunocompromised individuals, including those known to be HIV positive (regardless of whether they are receiving antiretroviral therapy). It is not necessary to screen for HPV infection or HIV infection prior to HPV vaccination. These schedule recommendations apply to both the bivalent and quadrivalent vaccines.
3. HPV vaccines can be administered at the same time as other non-live vaccines. Administering more than one vaccine at a single visit increases the likelihood that girls will receive all needed vaccines on schedule. See Table 4.1 for other non-live vaccines that have been shown to be safe and effective for co-administration. Guidance will be updated as results of ongoing co-administration studies become available.³
4. All formulations of HPV vaccine should be kept cold at 2–8°C. HPV vaccines are freeze-sensitive and lose efficacy if frozen. Therefore, HPV vaccine cannot be placed in or near the freezer portion of the refrigerator nor directly on a frozen ice pack. If there are indications that HPV vaccines may have been affected by sub-zero temperatures, a shake test should be conducted to determine whether the vaccine can still be used. Vials that show evidence of partial or total freezing of the contents should always be discarded. See Practice Sheet 4.2 for how to determine whether a vaccine has experienced freezing and for more details refer to the article in the Bulletin of the World Health



³ For further information please see the *Meeting of the Strategic Advisory Group of Experts on immunization, April 2014* – conclusions and recommendations, available at: <http://www.who.int/wer/2014/wer8921.pdf>

Organization on *Validation of the shake test for detecting freeze damage to adsorbed vaccines*,⁴ and view two instructional videos: *Shake and tell* (22 minutes) and *Step by step shake test* (10 minutes).

5. For reduction of cervical cancer, HPV vaccination of boys and men is less cost-effective than using those resources for reaching a high proportion of girls in the target age group.⁵

Please consult the webpage entitled *WHO recommendations for routine immunization – summary tables* on the WHO website, which is regularly updated with new data and any changes made to the WHO vaccine recommendations.⁶

4.3 Target population and delivery strategies

4.3.1 Target population

WHO recommends routinely administering HPV vaccine to girls 9–13 years of age because, in most countries, they have not yet started sexual activity.⁷ The target age should be determined at the country level based on the available information on the average age of initiation of sexual activity in girls (hence prior to exposure to HPV).

HPV vaccine is safe to administer to people with HIV, for whom a three-dose schedule is always recommended. There is little information available on the immunogenicity of HPV vaccines in people who are immunocompromised due to medications or diseases. Although immunogenicity and efficacy of HPV vaccines may be reduced in women and girls with HIV, the potential benefit of vaccination in this group is particularly great due to their increased risk of HPV-related disease, including cervical cancer. Studies are ongoing to monitor the efficacy and long-term protection of HPV vaccination in people with HIV.

If resources are available, countries may wish to consider time-limited catch-up vaccination of girls who are older than the target age group but who may still benefit from vaccination.

⁴ Kartoglu Ü, Özgüler NK, Wolfson LJ, Kurzatkowski W. Validation of the shake test for detecting freeze damage to adsorbed vaccines. *Bull World Health Organ.* 2010;88:624–31 (<http://www.who.int/bulletin/volumes/88/8/08-056879/en/index.html>, accessed 18 July 2014).

⁵ Available at: <http://vimeo.com/8381355> (*Shake and tell*); <http://vimeo.com/8389435> (*Step by step shake test*)

⁶ Available at: http://www.who.int/immunization/policy/immunization_tables/en/

⁷ Although HPV vaccines are recommended in young girls before onset of sexual activity, it is counter-productive to ask a girl if she has been sexually active before she is offered the vaccine; rumours may emerge that this information will not be kept confidential and consequently some girls may prefer not to attend vaccination days.

4.3.2 Delivery strategies

Introducing a new vaccine with a new target age requires addressing many logistical and programmatic issues. Implementing new HPV vaccine programmes may require use of unique and innovative delivery strategies, including using venues where large numbers of target-aged girls can be reached with education and services to ensure completion of the recommended dose schedule.

The ideal strategies for delivery of HPV vaccine, as outlined in the 2013 *WHO guidance note: comprehensive cervical cancer prevention and control*,⁸ should be:

- compatible with existing vaccine-delivery infrastructure and cold chain capacity
- affordable, cost-effective and sustainable
- able to achieve the highest possible coverage.

In practice, countries may need to balance strategies that maximize coverage with those considered most feasible, affordable and sustainable.

The WHO guidance note further recommends prioritizing two considerations: reaching girls who, later in life, will be least likely to have access to cervical cancer screening; and, wherever possible, selecting approaches that would provide opportunities for integration with other adolescent health services.

It is possible that no single delivery strategy is able to meet all the programme objectives. Ultimately, a combination of strategies may be needed to achieve high coverage and avoid disruption of established services while optimizing resources.

This guide provides information on two commonly used strategies: (1) vaccine delivery at health-care facilities, and (2) vaccine delivery through outreach. School-based delivery can be considered a special form of outreach as it takes place outside the health-care facility, at locations in the community.

Each strategy has pros and cons, which will be noted. If the target population lives both in urban and rural communities, including locations distant from health-care facilities, and if a segment of them may be transient and/or homeless, then using a combination of strategies would probably reach the largest number of them. These considerations should be taken into account when developing support strategies such as vaccination cards for monitoring purposes. Providing each girl with a vaccination card that she can manage can assist her in keeping track of her HPV vaccination doses, even if they are received at different venues.

⁸ Available at: <http://www.who.int/reproductivehealth/publications/cancers/9789241505147/en/>

a. Vaccine delivery at health-care facilities

This method provides opportunities for all eligible girls to receive HPV vaccination at a fixed health-care facility. This strategy reduces transport and personnel costs (such as travel allowance) to the health system because it relies on the girls to come to the facility. Demonstration projects in several countries have shown that it is possible to achieve high HPV vaccine coverage through offering vaccination at health centres in areas where the majority of girls live close to the facilities, such as in urban communities. This strategy has also been shown to achieve more coverage if offered as “vaccination days” with minor incentives for girls who attend, such as short waiting periods, and music, discussion groups and/or videos in the waiting room.

b. Vaccine delivery through outreach

In the context of immunizations, outreach refers to any strategy that requires health workers to leave their facility to transport and deliver immunization services to a variety of fixed or mobile sites close to large numbers of target-aged girls. Some examples of outreach venues are community centres, school buildings and, if appropriate and with the support of people in charge, places of worship, and other places where girls tend to congregate.

School-based (outreach) strategy

For girls living in distant communities and others who cannot attend clinic services, a strategy that shows promise is school-based vaccination. To select eligible girls for vaccination, a school-based strategy may target all girls in a selected school year/grade/class where the majority are between the ages of 9 and 13 years (e.g. 4th year of primary school) or may target girls of specific ages (e.g. all 10-year-olds), regardless of which year/grade/class they are in at school.

In addition to vaccination, this strategy can serve as an opportunity to create or strengthen school health services and improve health education and communication.

In a school with a school health programme that includes a health-care provider, the provider can be trained and charged with vaccinating target-aged girls with modest additional support from the nearest health centre.

If, however, a school-based delivery strategy must depend on having immunization teams present at the school for several days, it may be too resource-intensive to implement, particularly if enrolment and attendance is low among girls in the target age group.

Where school-based vaccination will not reach a large proportion of eligible girls with an opportunity to get the HPV vaccine, either because they are not enrolled or because of absenteeism, this strategy must be supplemented by strategies to reach girls who are not in school, to ensure equitable access to the vaccine. Teachers and community workers and leaders can play important roles in identifying these girls, educating, motivating and assisting them to access vaccine services at other sites.

Other outreach strategies

Where a large proportion of the population lives in areas with limited access to health services and there is low school attendance for target-aged girls, an outreach delivery strategy in a central location may be appropriate. Girls in that community and surrounding communities can come to a central location for vaccination, to ensure equitable vaccination opportunities for all adolescent girls. At least two sessions would be needed over a period of 6–12 months to reach all girls with the required doses.

Outreach can be done on a scheduled basis or irregularly, such as during “mop-up” outreach.

Role of community health workers (CHWs) in outreach efforts

To facilitate an outreach strategy, taking into account that many target-aged girls live in poor, distant and isolated communities and do not attend school, one approach may be to train CHWs (if permitted by national guidelines) to:

- transport and maintain sufficient vaccines for all girls aged 9–13 years in an appropriate cold storage device, such as a cool box;
- administer the required doses of vaccines to those girls who fit eligibility criteria; and
- record vaccinations on standardized forms.

Training and supervising CHWs to counsel, determine absence of contraindications, and to administer injections safely and correctly has been successfully implemented in many countries with provision of childhood vaccinations, contraceptive injections (DMPA, Depo-Provera®), and syndromic treatment of childhood pneumonias and men’s and women’s sexually transmitted infections (STIs). For more information, see Chapter 3: Community mobilization, education and counselling. Details on recruitment and training of CHWs can be found in Practice Sheet 3.7. Guidance on injection safety is provided in Practice Sheet 4.4.



Recruit and train CHWs



Injection safety

4.3.3 Integrated services

Co-administration of HPV vaccination with other interventions (such as deworming or distribution of insecticide-treated mosquito nets), concurrent administration with other age-appropriate vaccines (see Table 4.1), and providing education on a variety of topics of special interest to this age group may promote sharing of resources and knowledge across programmes. This will serve to upgrade provider knowledge and communication skills and optimize costs and logistics, thus increasing the broader efficiency and effectiveness of services. Outreach strategies for delivery of HPV vaccinations are particularly conducive to integration with other health services for children and adolescents.

4.4 Community mobilization

The success of HPV vaccine delivery depends on creating a high level of community awareness, through information, education and communication (IEC) activities, as well as counselling with parents, and other influential people in communities.

Prior to actual vaccine-delivery activities, assessment of knowledge, attitudes and beliefs about HPV vaccines can help programme staff to be prepared to address any barriers or sensitivities they may encounter, such as fear of adverse effects and misconceptions regarding the effect of vaccination on fertility. In addition, a vaccine against an STI that is recommended only for young girls can be confusing to parents and may lead to unnecessary reluctance to vaccinate daughters who are not yet sexually active, even though this is the age when they are most likely to benefit from it.

Involvement and coalition-building with a broad range of government and nongovernmental stakeholders throughout a community can facilitate successful introduction and implementation of HPV vaccines. School-based vaccination requires close coordination between the national ministries of health and education, and the collaboration of school officials at district, regional and local levels.

See Chapter 3 for further information on community mobilization.

4.5 Obtaining consent/assent for a girl to get vaccinated

Guidance on informed consent may be obtained from national laws and regulations. In general, informed consent requires the health worker to fully inform a patient of the risks and benefits of any planned intervention and then obtain verbal or written consent. Because most vaccinations are given to children who are too young to provide legal consent, parents provide what is known as parental consent. Often countries use an implied consent strategy in which the parent's consent is implied when voluntarily bringing a child to be vaccinated at a health clinic.

In the case of HPV vaccination, the targeted girls are no longer small children, and may come in for vaccination without a parent present. Since the girls are still minors under the law, carrying out the parental consent process will still be required in most countries; this needs to include informing the parents and the girl of the planned vaccination and, at a minimum, depending on the country's regulations, providing a parent with the opportunity to opt out of vaccination for his or her child.

Some health authorities may require explicit written consent to be obtained from parents. This will have planning, logistical and resource implications and may require, for example, teachers and school officials working with the girls (students) who will be vaccinated to obtain their parents' consent in advance of the vaccination session. In addition to parents/guardians, girls receiving the HPV vaccination also need to be fully informed of the risk and benefits, so that they can "assent" to the treatment.

Situations may arise in which the girl expresses the wish to be vaccinated while her parent explicitly refuses to provide consent or this consent cannot be produced. In this situation, an additional consideration is to take account of the best interest of the child. Internationally accepted ethical principles require the health worker to first assess whether a girl is "competent" to make this decision: she demonstrates understanding of the benefits, risks and consequences of the vaccination versus not having the vaccination, and is capable of making this decision for herself. If the girl is considered competent, the health worker can then decide to go ahead with the vaccination. Being aware of these principles is important, especially when dealing with marginalized and disadvantaged girls such as those who are orphaned, live on the streets or work far away from their families. In some countries there are regulations permitting community authorities, such as social workers or school officials, to provide consent for children under their responsibility in certain circumstances.

Finally, in cases where the parent or guardian has consented to vaccination for the girl, but the girl herself refuses to be vaccinated, her wishes should be respected and she should be allowed to leave after being invited to return at another time to discuss the decision further.

4.6 Monitoring and evaluation and sustainability of HPV vaccination programmes

4.6.1 Monitoring

The precise number of girls in a given population is needed for calculating HPV vaccine coverage, in order to monitor the performance of a vaccine programme and evaluate its impact at a later date. It is important to have a monitoring system in place that:

1. tracks the flow of information and forms;
2. clearly specifies who should receive the completed monitoring forms and when they are due; and
3. explains what to do with the information gleaned from monitoring.

Since HPV vaccination is recommended as a multidose series of injections, at a minimum the collection and recording of coverage data (by dose, including age/birthdate and date of vaccination) are necessary (see Practice Sheet 4.3, and Sample Forms 6.1–6.3 in Annex 6).

The *WHO HPV vaccination coverage monitoring guide and tool* is available for local adaptation and use.⁹ Summarized standard data collection and reporting tools, which need to be further developed at the national level, are listed in Practice Sheet 4.5.

a. Monitoring and reporting adverse events following immunization

An adverse event following immunization (AEFI) can be described as an adverse clinical event that is temporally related to vaccination but may or may not be caused by the vaccine or the vaccination process. AEFIs can range from minor events such as a mild reaction at the injection site to life-threatening events including anaphylaxis and possibly death. Although an AEFI can be caused by the vaccine itself, such as an allergic reaction, reported AEFIs are more commonly either coincident events that are unrelated to the vaccine or events that have been caused by programme/human errors that have compromised the vaccine quality.

Monitoring HPV vaccine safety is of particular importance because it is a new vaccine and is administered to an age group not previously targeted for vaccination. Groups opposed to vaccines for any reason may initiate or perpetuate rumours of poor vaccine safety, pointing to spurious associations with coincident adverse events to discourage HPV vaccination in the population. Because misinformation can be detrimental to vaccine acceptability and vaccination efforts, a robust AEFI monitoring infrastructure is essential for gathering information that may help to dispel rumours and demonstrate continued safety of HPV vaccines.



Immunization session



HPV immunization sample forms



M & E

⁹ Available at: <http://www.who.int/immunization/diseases/hpv/resources/en/>

AEFIs can be classified into five categories:¹⁰

1. Vaccine product-related reaction: An AEFI that is caused or precipitated by a vaccine due to one or more of the inherent properties of the vaccine product (e.g. extensive limb swelling following DTP vaccination).
2. Vaccine quality defect-related reaction: An AEFI that is caused or precipitated by a vaccine due to one or more quality defects of the vaccine product, including its administration device as provided by the manufacturer (e.g. failure by the manufacturer to completely inactivate a lot of inactivated polio vaccine leads to cases of paralytic polio).
3. Immunization error-related reaction: An AEFI that is caused by inappropriate vaccine handling, prescribing or administration, which thus by its nature is preventable (e.g. transmission of infection by contaminated multidose vial).
4. Immunization anxiety-related reaction: An AEFI arising from anxiety about the immunization (e.g. fainting in an adolescent during/following vaccination).
5. Coincidental event: An AEFI that is caused by something other than the vaccine product, immunization error or immunization anxiety (e.g. a fever occurs at the time of the vaccination but is in fact caused by malaria).

Common, mild adverse HPV vaccine reactions resolve spontaneously and rarely require treatment include redness, pain or swelling at the injection site, fever, dizziness, nausea and fainting (see section 4.22).

On the other hand, serious adverse events are extremely rare. Anaphylaxis can be causally related to HPV vaccination and precautions should be taken to avoid vaccinating girls who have had previous allergic reactions to vaccine components. If anaphylaxis is suspected, the girl should immediately be treated as needed. These girls should not receive subsequent HPV vaccine doses or other vaccines that contain similar vaccine components.

A system should be in place to facilitate prompt reporting and investigation of AEFIs. National regulatory authorities and national immunization technical advisory groups (NITAGs) should take a proactive role in investigating reports of serious adverse events to assess whether there is a link to the HPV vaccine and develop communication messages to address rumours.

All suspected AEFIs should be immediately reported to health authorities using a standard AEFI reporting form (see Practice Sheet 4.6, and Sample Form 6.4 in Annex 6).



AEFIs

¹⁰ Further information on WHO's classification of AEFIs is available at: <http://vaccine-safety-training.org/classification-of-aefis.html>

Serious events, such as death, hospitalization or a geographic cluster of AEFIs, should be rapidly investigated (within 48 hours). It is crucial to be prepared for the occurrence of AEFIs and have a risk management plan in place.

4.6.2 Evaluation

WHO recommends that all countries that have introduced a new vaccine should conduct post-introduction evaluation approximately 6–12 months after introduction. WHO has published a *New vaccine post-introduction evaluation (PIE) tool*, which provides a systematic method for evaluating the impact of the introduction of a vaccine on the existing immunization system in a country.¹¹ The PIE tool is designed for immunization managers in countries that have introduced a new or underutilized vaccine. A specific PIE tool for HPV vaccine introduction is available at WHO's Immunization, Vaccines and Biologicals website.¹²

4.6.3 Sustainability

Sustainability of any new programme needs to be considered before it is implemented. In the case of HPV vaccination, this includes careful assessment of the burden of disease imposed by cervical cancer, size and urban–rural distribution of the target population, estimated costs and available resources. In addition, costs of infrastructure modifications, training and supervision, and available staff time should be taken into consideration. Based on the assessment, the Ministry of Health (MOH) may decide to seek additional support from the Ministry of Finance for resource mobilization, as well as from multinational agencies to obtain free or greatly discounted vaccines. Once the resources are assured, the introduction strategy needs to be defined. Cost-effectiveness evaluations can be conducted as a basis for policy decisions on whether and how to introduce HPV vaccines, taking into consideration the overall burden of disease in the country, the costs of managing the disease as well as costs of the HPV vaccine, and the long-term health benefits of the HPV vaccine.

Examples of important considerations for sustainability planning can be found in Chapter 2, in the section on national policy development. Other useful resources can be found at the WHO webpage on *Immunization planning and financing*¹³ and in the WHO–UNICEF *guidelines for developing a comprehensive MultiYear Plan (cMYP)* for immunization/vaccines.¹⁴

¹¹ Available at: http://www.who.int/immunization/monitoring_surveillance/resources/PIE_tool/en/

¹² Available at: <http://www.who.int/immunization/diseases/hpv/resources/en/>

¹³ Available at: http://www.who.int/immunization/programmes_systems/financing/en/

¹⁴ Available at: http://www.who.int/immunization/documents/control/WHO_IVB_14.01/en/

After studying these issues, decision-makers must decide whether the proposed programme is affordable and sustainable.

- If it is determined to be affordable and sustainable at present, they must allocate the necessary funding for more than one year.
- If it is not affordable and/or not sustainable as proposed, the proposal must be reviewed and revised with a view to reducing costs wherever possible, including changing the priority target population and/or changing the delivery strategies.

Further reading

Useful websites:

WHO – Human papillomavirus (HPV): www.who.int/immunization/topics/hpv

This page provides information on HPV disease burden and HPV vaccine characteristics and safety. It includes links to:

- HPV Vaccine Introduction Clearing House, with technical documents from WHO and partners on various programmatic aspects of HPV implementation, including communication and linkages to adolescent health
- WHO position papers on HPV vaccines (including translations)
- Key points and technical information on HPV vaccines for policy-makers and health professionals
- HPV vaccine policy and programme guidance for countries
- Data on cervical cancer incidence and mortality worldwide

WHO – Human papillomavirus (HPV) vaccine programmatic resources:

www.who.int/immunization/diseases/hpv/resources

This page includes additional links to:

- Essential training package for HPV vaccine introduction (health worker training materials)
- WHO population estimates of the 9–13 year old age cohort, by single year of age, sex and country, 2010–2020
- WHO Cervical Cancer Prevention and Control Costing Tool (C4P Tool)
- Other WHO tools and materials relevant for HPV vaccination implementation

WHO – Vaccine Safety Basics e-learning course: <http://vaccine-safety-training.org/classification-of-aefis.html>

This course comprises six modules, including Module 3 on adverse events following immunization: classification of AEFIs.

GAVI Alliance – Apply for support: www.gavialliance.org/support/apply/

This webpage provides information and assistance on applying for support from GAVI for HPV demonstration programmes or national introduction (GAVI-eligible countries only).

WHO recommendations for routine immunization – summary tables: http://www.who.int/immunization/policy/immunization_tables/en/

This webpage is regularly updated with new data and any changes to the recommendations.

5

CHAPTER 5. SCREENING AND TREATMENT OF CERVICAL PRE-CANCER

Chapter 5. Screening and treatment of cervical pre-cancer

Key points

- Early detection, by screening all women in the target age group, followed by treatment of detected precancerous lesions can prevent the majority of cervical cancers.
- Cervical cancer screening should be performed at least once for every woman in the target age group where most benefit can be achieved: 30–49 years.
- Cervical cancer screening, at least once, is recommended for every woman in the target age group, but this may be extended to women younger than age 30 if there is evidence of a high risk for CIN2+.
- HPV testing, cytology and visual inspection with acetic acid (VIA) are all recommended screening tests.
- For cervical cancer prevention to be effective, women with positive screening test results must receive effective treatment.
- It is recommended to take either a “screen-and-treat” approach or a “screen, diagnose and treat” approach.
- Decisions on which screening and treatment approach to use in a particular country or health-care facility should be based on a variety of factors, including benefits and harms, potential for women to be lost to follow-up, cost, and availability of the necessary equipment and human resources.
- In the screen-and-treat approach, the treatment decision is based on a screening test and treatment is provided soon or, ideally, immediately after a positive screening test (i.e. without the use of a diagnostic test).
- The screen-and-treat approach reduces loss to follow-up, and can reduce the time lag for women to receive treatment.
- Among women who test negative with VIA or cytology, the interval for re-screening should be three to five years.
- Among women who test negative with HPV testing, re-screening should be done after a minimum interval of five years.
- If cancer is suspected in women who attend screening, they should not be treated but should be referred to a facility for diagnosis and treatment of cancer.
- Cryotherapy or loop electrosurgical excision procedure (LEEP) can provide effective and appropriate treatment for the majority of women who screen positive for cervical pre-cancer.

About this chapter

This chapter is based on the following WHO guidelines:

Monitoring national cervical cancer prevention and control programmes: quality control and quality assurance for visual inspection with acetic acid (VIA)-based programmes. Geneva: WHO; 2013 (<http://www.who.int/reproductivehealth/publications/cancers/9789241505260/en/>).

WHO guidelines for screening and treatment of precancerous lesions for cervical cancer prevention. Geneva: WHO; 2013 (http://www.who.int/reproductivehealth/publications/cancers/screening_and_treatment_of_precancerous_lesions/en/).

WHO guidelines for treatment of cervical intraepithelial neoplasia 2–3 and adenocarcinoma in situ. Geneva: WHO; 2014 (http://www.who.int/reproductivehealth/publications/cancers/treatment_CIN_2-3/en/).

WHO guidelines: use of cryotherapy for cervical intraepithelial neoplasia. Geneva: WHO; 2011 (<http://www.who.int/reproductivehealth/publications/cancers/9789241502856/en/>).

WHO technical specifications on cryosurgical equipment for the treatment of precancerous cervical lesions and prevention of cervical cancer: WHO; 2012 (<http://www.who.int/reproductivehealth/publications/cancers/9789241504560/en/>).

This chapter provides detailed information on screening and treatment for cervical pre-cancer. It includes seven main sections, beginning with a description of the considerations relating to health-care providers (section 5.1), followed by an overview of issues relating to cervical cancer screening, including risks and benefits and ethical considerations (section 5.2). Section 5.3 describes the available screening tests (molecular HPV testing, visual screening methods and cytology-based screening) and their comparative strengths and limitations.

Section 5.4 reviews diagnostic modalities (colposcopy, biopsy and endocervical curettage) used to confirm and map abnormalities in some women with positive results on screening. In section 5.5, treatment procedures for detected pre-cancer (cryotherapy, LEEP and cold knife conization) are described in some detail, including indications, strengths and limitations of each procedure. Section 5.6 covers possible complications and follow-up after treatment.

Finally, section 5.7 of this chapter emphasizes that to have an impact on the incidence and mortality associated with cervical cancer, it is essential to link screening to further management for all women who receive a positive screening result. Programmatic strategies that can be used to successfully accomplish this crucial link are the “screen, diagnose and treat” approach, or the “screen-and-treat” approach – both are discussed.

Recommendations presented in this chapter for the screening and diagnostic tests and treatments to use in a cervical cancer prevention and control programme meet WHO evidence-based criteria and provide guidance to programme managers and health-care providers.

The practice sheets pertaining to this chapter contain need-to-know information for the service provider on the steps for obtaining informed consent, performing a pelvic examination, and for conducting each screening test and treatment modality discussed. Practice Sheet 5.7 includes guidance on counselling patients after positive screening results.



Counselling: +ve

Maria's story

Maria is a 40-year-old Nicaraguan woman who, with her husband and three children, lives in a rural community. The community health worker came to visit and informed her that she is of an age when a woman should be tested to see if there have been any changes on her cervix that could get worse if not treated, and which could eventually, many years later, turn into cancer. She was then invited to attend a clinic in a nearby community where a team of nurses from the local hospital would be coming to provide all women aged 30–49 years with a test for pre-cancer of the cervix. She would be given the result of the test before returning home and all women needing treatment can also have it the same day before going home. Several days before the clinic, a nurse came to Maria's community and gathered all the women to give them information about the test that would be used and details about the treatment, including the fact that neither the test nor the treatment cause much pain but may be uncomfortable.

On the day of the clinic, Maria and 10 other women from her community walked together to the clinic with the community health worker; there they sat with an auxiliary nurse in a private spot where each woman had her health history taken and was able to receive answers to all her questions. The test was performed in a private room and after Maria was dressed, she was told that her cervix was normal and that she just needed to have the test repeated in five years' time. Of the 10 women who came with her, two were told their cervix had a slight abnormality that needed treatment so that it wouldn't get worse. One decided to be treated the same afternoon and the other decided she wanted to come back with her partner to the follow-up clinic a week later in the same place. Both women who needed treatment were quite glad they had gone to the clinic and felt very pleased with their experience; they then recommended to their female relatives and friends between the ages of 30 and 49 years to follow the same path and get screening – and treatment, if needed – so they, too, could stay free from cervical cancer.

5.1 Health-care providers

5.1.1 The role of health-care providers

The health-care provider is a central figure in any coordinated public health effort to prevent and control cervical cancer. The role of the health-care provider at all levels is to ensure that women are educated about cervical cancer, that quality services are offered, and that women who need it receive the appropriate follow-up care and treatment for positive screening results or for invasive cervical cancer. Health-care providers work in coordination with each other and with the ministry of health, programme planners, managers and community workers to ensure an effective programme.

5.1.2 Who can provide good quality screening?

With competency-based training, any provider who knows how to do a speculum examination can perform any of the cervical cancer screening tests (i.e. nurse, auxiliary or assistant nurse, trained midwife, clinical officer or medical doctor). For more information on training community health workers, see Practice Sheet 3.7.



5.1.3 Client assessment and preparation for screening

Women should have a basic assessment before proceeding to the screening test; it should include information and counselling, a brief social and clinical history, and a simple pelvic examination. The following points provide further details relating to the role of health-care providers at this stage:

- Because of the stigma that may be associated with genital problems, women can be reluctant to talk about their concerns or symptoms. To establish and maintain trust, efforts to ensure confidentiality and privacy can be very helpful in reducing their reluctance.
- The benefits and risks of cervical screening should be discussed as part of general health education (see section 5.2.3). Women need to understand that screening is NOT a test for cancer; it only identifies women who may develop cancer in the future. Providing a basic idea of how the test works can also help to alleviate anxiety or fears.
- The essential components of the clinical pelvic examination are visual inspection of the external genitalia and a speculum examination (see Practice Sheet 5.2). Providers should explain what is being done at each step during the examination. If an abnormality is noted, the provider should inform the woman without alarming her, but this is best done after the examination is completed.

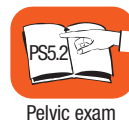

- For some women, having female providers perform the pelvic examination may reduce reluctance to be examined and increase the acceptability of screening. When the provider is a man, presence of a female companion or clinic attendant in the room may reduce the patient's anxiety.

5.1.4 Other health problems detected during screening

The woman and her health needs must be the focus of prevention programmes. When possible, providers should adopt a comprehensive approach to identification and management of sexual and reproductive health problems. The provider should pay particular attention to signs and symptoms suggestive of cancer, sexually transmitted infections (STIs) or other conditions detected during history-taking and pelvic examination. Women with abnormal findings unrelated to cervical cancer screening can be treated or referred, as appropriate. In addition, women should be offered an opportunity to raise personal concerns regarding sexual and reproductive health issues, such as any unmet need for family planning.

5.2 Cervical cancer screening

5.2.1 What is screening?

Screening is a public health intervention provided to an asymptomatic target population. Screening is not undertaken to diagnose a disease, but to identify individuals with increased probability of having either the disease itself or a precursor of the disease.

Not all diseases are appropriate for a screening programme. The following criteria help determine whether a disease is appropriate for a screening programme:

- The disease must have serious consequences.
- The disease must have a detectable preclinical, asymptomatic stage.
- Treatment of the preclinical stage must favourably influence the long-term course and prognosis of the disease being screened for.
- Treatment must be available and accessible for those who have a positive screening test.

The natural history, screening tests and treatment options for cervical pre-cancer meet these criteria.

5.2.2 Cervical cancer screening: an overview

Cervical cancer prevention programmes aim to screen the largest possible proportion of women targeted by the national programme and ensure appropriate management

for all those who have a positive or abnormal test result. Chapter 2 addresses programmatic considerations for cervical cancer prevention and control.

5

5.2.3 Benefits and risks of cervical cancer screening

While effective prevention programmes hold out the promise of dramatically decreasing the incidence of cervical cancer, any large-scale screening effort directed towards healthy populations can have both positive and negative outcomes.

The primary positive outcome of screening is the reduction of cervical cancer by detecting and treating cases of pre-cancer before they progress to cancer. Additionally, screening can detect cervical cancer in women at an early stage when the cancer can still be successfully treated.

Screening, by itself, has no actual preventive value. A link to treatment is essential. If such a link cannot be implemented then the screening programme is likely to have no impact on the incidence of cervical cancer. Positive outcomes in terms of the quality of the health-care facilities and services can also be achieved through implementation of a prevention programme; these may include improved infrastructure, updated training of health-care providers, increased awareness of women's reproductive health, and establishment of a quality control and quality assurance programme (see Chapter 2).

One risk of screening, which applies to all screening tests described, is a variable rate of over-detection of pre-cancer (i.e. false-positive results), which leads to overtreatment of women who are in fact not at increased risk of invasive cancer at that time. Nevertheless, the benefits of detecting cervical pre-cancer early (i.e. true-positive results) – when treatment to prevent progression to cancer is available – far outweigh the relatively minor consequences to women caused by any of the treatment methods described.

Another, more significant risk of screening is the risk of obtaining a false-negative result, which may result in missing signs of disease and thus a missed opportunity for treatment of pre-cancer or early cancer.

Care must be taken to ensure that screening is performed only on the target population defined by the national programme, and that adequate resources are allotted to cover screening for 100% of these women along with the necessary follow-up.

The screening programme also needs to assure there is a functioning referral system so that women who are found to have cancer will receive appropriate referral and management.

5.2.4 Characteristics of a good screening test

A good screening test should be:

- **Accurate:** the result of the test is correct
- **Reproducible:** repeating the same test will give the same result
- **Inexpensive:** affordable to the health system in terms of both financial and human resources, and to all patients and their families in terms of access to necessary services
- **Relatively easy:** uncomplicated to perform and to provide follow-up care for women with abnormal results
- **Acceptable:** well tolerated by both the patient and the provider
- **Safe:** the test procedure and management of screen-positive subjects have no or minimal adverse effects
- **Available:** accessible to the entire target population.

Top-level decision-makers must select which screening tests and treatments are to be implemented in a given setting. This selection should be made by considering the trade-offs between each test's performance, its capacity to be performed at each given level of the health system, its affordability and sustainability, and its potential for reaching the whole target population. This may result in, for example, choosing different tests for use at urban and rural sites.

In theory, the best screening test is the one that has the lowest rate of false-negative results (i.e. when the result is negative/normal but the woman actually does have the disease), and simultaneously has the lowest rate of false-positives (i.e. when the result is positive but the woman actually has no abnormalities). False-negatives can lead to an increased risk of cancer if frequent screening is not available. False-positives can lead to overtreatment and increased anxiety for patients.

In practice, it is important to choose the most appropriate screening test considering both the particular setting where the programme will be implemented and the human, financial and infrastructure resources available for using the chosen test. The test must be suitable for population-based screening programmes to ensure that it reaches the entire target population and not only those with greater access to health services. For long-term sustainability, the health system must have the capacity to maintain necessary equipment and to replace required supplies. Choosing the best test is a balance of all of these factors.

5.2.5 Screening age and frequency

World Health Organization (WHO) recommendations on target age and frequency of screening are based on current evidence available at the time of publication and on the natural history of HPV and cervical pre-cancer (see Chapter 1). High-risk HPV infections are very common in young women, but most of these infections are transient: they are eliminated spontaneously by the woman's body. Only a small percentage of all HPV infections that persist for many years may lead to invasive cancer. Cervical cancer usually develops slowly, taking 10–20 years from early pre-cancer to invasive cancer, so cervical cancer is rare before the age of 30. Screening younger women will detect many lesions that will never develop into cancer, which will lead to considerable overtreatment, and is thus not cost-effective.

Cervical cancer screening should not start before 30 years of age. Screening women between the ages of 30 and 49 years, even just once, will reduce deaths from cervical cancer. Cervical cancer screening is recommended for every woman in this target age group, but this may be extended to younger ages if there is evidence of a high risk for CIN2+.

Decisions about the target age group and frequency of screening are usually made at the national level on the basis of the local proportion of women with pre-cancer or cancer out of all women of the same age, the number of new cervical cancer cases recorded in the last two or three years, and the availability of resources and infrastructure, as well as other factors, such as HIV prevalence.

To have the maximum impact in terms of reducing cervical cancer suffering and death, priority should be given to maximizing coverage¹ and treatment rather than maximizing the number of screening tests in a woman's lifetime. This is true for all women regardless of HIV status.

Among women who test negative with visual inspection with acetic acid (VIA) or cytology, the interval for re-screening should be three to five years. Among women who test negative with HPV testing, re-screening should be done after a minimum interval of five years. After a subsequent screening with negative test results, and also for older women, the screening interval can be longer than five years. Women who have been treated for cervical pre-cancer should receive post-treatment follow-up after 12 months.

¹ "Coverage" refers to the proportion of women in the target age group who are screened at the recommended intervals during a given time period. The actual number of screening tests performed does not measure coverage, since this number may include women outside the target age, and women screened more often than recommended.

a. Screening for women living with HIV

Recommendations for women living with HIV:

- Screening for cervical pre-cancer and cancer should be done in women and girls who have initiated sexual activity as soon as the woman or girl has tested positive for HIV, regardless of age.
- Women living with HIV whose screening results are negative (i.e. no evidence of pre-cancer is found) should be rescreened within three years.
- Women living with HIV who have been treated for cervical pre-cancer should receive post-treatment follow-up after 12 months.

Women living with HIV have a higher risk of having persistent HPV infections, and a higher risk of developing pre-cancer. In addition, women living with HIV are more likely to develop cervical cancer earlier and to die from it sooner. Because they develop pre-cancer at a younger age and the time for pre-cancer to progress to cancer can be shorter, women living with HIV are advised to follow a different screening schedule: after a negative screening test result, they should be re-screened within three years (see the screen-and-treat flowcharts for women living with HIV in Annex 9). Any of the three screening tests in this chapter (VIA, HPV test or cytology) can be used for women living with HIV, as can cryotherapy and loop electrosurgical excision procedure (LEEP) treatments.



HIV screening is not mandatory for cervical cancer screening. However, in an area with high endemic HIV infection, women should be screened for HIV so that they know their status and, if positive, they should be counselled on the meaning of the test result and provided with appropriate treatment and follow-up care. In countries with a high prevalence of HIV, cervical cancer control services, as discussed in Chapter 2, would benefit patients most if there was two-way integration with HIV services; i.e. women receiving either HIV or cervical cancer screening services, if they were not already aware of their HIV status or had not had recent cervical cancer screening, could be routinely offered screening for the other disease. It is not uncommon for a woman to learn for the first time that she is HIV-positive at the time of attending for cervical cancer screening.

5.2.6 Ethical considerations for cervical cancer screening programmes

Decisions on how best to use scarce resources to diagnose and treat cervical pre-cancer must consider the extent of disability and death caused by the disease and the likely success of an intervention to reduce the suffering and death associated with that disease versus using these scarce resources to prevent or control other illnesses.

Cervical cancer, when seen through this lens, can cause a high burden of disability and death and the intervention (screening and treatment of pre-cancer) can prevent most of the disease. This makes cervical cancer prevention and control a rational and ethical choice for the use of available resources.

While decisions about programmatic priorities are usually made at the national level, health-care providers should understand the reasons for the decisions, so that they are motivated to implement the programme in a cost-conscious manner and explain the priorities of the programme to their patients.

Before a screening programme is implemented, the following elements should be considered to ensure an ethical and equitable approach:

- Pre-cancer screening and treatment, as well as management of cervical cancer, should be accessible to all women in the target age group, including the poorest, most vulnerable, and hardest to reach.
- Treatment should be available and accessible. Diagnostic or confirmatory tests (if they are included in the programme) also must be available with appropriate follow-up after the test is performed.
- Patients, providers and communities should receive health education to ensure informed decision-making on screening and treatment.
- Patient record systems and patient care should ensure confidentiality.
- Providers should be adequately trained and have clear guidelines on management and follow-up of women with positive screening results.
- A referral system should be in place for all health problems discovered during the screening process including:
 - treatment and palliative services for cervical cancer, and
 - treatment for other reproductive health disorders.

a. Informed choice and informed consent

Informed choice: The patient is given enough information so that she can make an informed choice about whether to accept or refuse the test or course of action proposed by providers. This information, which will be repeated and confirmed just before any intervention is conducted, needs to include (in the case of cervical cancer prevention) the meaning and consequences of a positive test, the availability of treatment, as well as the risks the patient may face should she refuse screening and related treatment.

Informed consent: This refers to the explicit verbal or written permission given by a patient to receive a procedure or test, once she (or he) has received sufficient information to make an informed choice.

Both informed consent and informed choice are based on the ethical principles of autonomy and respect for the individual. In many cultures, the notion of consent may be a collective decision-making process involving others, such as the husband/partner, family, and/or village leaders. Accurate information provided through health education and counselling can ensure that women and their extended families understand the facts about cervical cancer, including who is at risk, how screening can reduce this risk, and any potential harm related to screening or treatment. After receiving this information, it is the patient who makes the choice with advice and support from others in her close circle. The health-care provider needs to be conscious of the possibility that the patient may be subject to coercion and should make efforts to assure that the patient's decision is not coerced.



Informed consent

See Practice Sheet 5.1 on obtaining informed consent.

5.2.7 Infection prevention for cervical cancer screening programmes

In all clinical activities, very careful attention should be given to infection prevention. Providers should use clean gloves on both hands when performing speculum or bimanual examinations, taking specimens, and performing procedures such as cryotherapy. For invasive procedures such as LEEP, providers should use sterile gloves.

Guidelines on hand washing, handling of instruments and disposal of used supplies, including gloves, should be followed carefully to prevent the transmission of pathogens, including HIV. It is important to use standard infection prevention and control (IPC) precautions (see Annex 3) with all patients, regardless of whether they appear sick or well, or whether their HIV or other infection status is known or unknown. In this way, providers protect both their patients and themselves from infection.



Infection prevention and control

It is worthwhile to make infection prevention efforts visible to the woman being screened (such as washing hands and changing to fresh gloves), to reduce any anxiety she may have about safety and hygiene.

5.3 Screening methods for cervical pre-cancer

Until a few years ago, the only method of screening for cervical cancer was the Papanicolaou (“Pap”) smear or cytology. In high-income countries, where Pap smears have been used for population-based screening for over three decades, there has been a major reduction in morbidity and mortality from cervical cancer. However, population-based cytology screening in low- and middle-income countries is often unsuccessful because the financial investments to establish and maintain

the necessary level of health infrastructure, including laboratory and skilled human resources, are not available or sufficient in many settings.

Newer methods have been developed for cervical cancer screening: molecular HPV screening tests and visual inspection with acetic acid. These newer methods are described below, in addition to cytology-based screening methods. See also Practice Sheet 5.3 for important notes about screening methods.



5.3.1 HPV testing

a. Description

Molecular HPV testing methods are based on the detection of DNA from high-risk HPV types in vaginal and/or cervical samples. Testing women younger than 30 years old for these viruses is not advised because many young women are infected with them, but most HPV infections will be spontaneously eliminated from their bodies before they reach the age of 30. Thus, HPV testing in women younger than this will detect many women with transient HPV infections and may subject them to unnecessary procedures and treatment which can cause harm, anxiety, discomfort and expense.

However, as a woman ages, if high-risk HPV is detected, it is more likely that her HPV infection is persistent. Since persistent HPV infection is the cause of nearly all cases of cervical cancer, a positive test result in a woman over the age of 30 indicates that she may have an existing lesion or may be at risk for future pre-cancer and cancer (see Chapter 1, sections 1.3.4 and 1.3.5). Treating these screen-positive women can therefore greatly reduce the risk of future cervical cancer.

HPV testing is being incorporated into cervical cancer prevention programmes in high-resource settings as a primary screening test. Currently the tests require transportation to and processing at a laboratory before results can be returned. But a new low-cost HPV test that can be processed on-site at the same facility where the sample is taken is being tested in several low-resource settings and will soon be available on the market.

When planning to use a molecular screening test for HPV in a cervical cancer screening programme, it is important to use a standardized, clinically validated HPV test. Locally developed HPV tests are not appropriate unless they have been rigorously standardized and clinically validated.

b. Who should be tested?

For the reasons described above, HPV testing should be reserved for women over the age of 30, or the age specified in updated national guidelines.

c. How to screen

HPV testing does not necessarily require a pelvic examination or visualization of the cervix. A health-care provider can collect a sample of cells by inserting a small brush or other appropriate device deep into the vagina, and then placing it in a small container with an appropriate preservative solution. It may also be collected at the time of a speculum examination.

The sample can also be self-collected by the woman; she can be given the brush and the special container and instructed how to use them. This strategy can be implemented at substantially lower cost to the health service and offers greater convenience to women.

For further instructions on sample collection methods for HPV testing, see Practice Sheet 5.4.



With the use of HPV testing as currently available, the specimen containers need to be transported to the laboratory for processing by a trained technician who then documents and returns the results. But new tests will soon allow for on-site processing.

d. Strengths and limitations

HPV testing is highly sensitive for detecting HPV infection in women. However, while an HPV infection is a necessary precursor for cervical cancer, a positive HPV test does not confirm that the woman has pre-cancer; it only confirms that there is an HPV infection. Sample collection for HPV testing can be done at any health-care or community setting, as long as there is an appropriate laboratory within a reasonable distance, and reliable transport for specimens.

At present, the need to process molecular HPV tests in a laboratory with a special clean room to avoid contamination and with equipment and reagents as specified by the manufacturers of the test as well as trained technicians can limit the utility of HPV screening in some settings. If there is no reliable method for processing and returning results to the patient within a reasonable time, this may present barriers to the use of HPV testing, in terms of cost and quality.

The new low-cost HPV tests that will soon be available on the market will address this limitation because they can be processed at the clinic where samples are collected, using simpler equipment, and requiring less training to perform.

5.3.2 Visual screening methods

a. Description

Visual inspection with acetic acid (VIA) is a method for detecting early cell changes that are visible when using a speculum to inspect the cervix with the naked eye after applying dilute (3–5%) acetic acid to it.² It requires training and supervision of primary care providers, as well as ongoing quality control and quality assurance.

b. Who should be tested?

VIA is appropriate to use in women whose squamocolumnar junction (SCJ) is visible, typically in those younger than 50 (see Chapter 1, section 1.2). This is because the SCJ gradually recedes into the endocervical canal when menopause occurs, making it possible to miss lesions when relying on visual inspection.

c. How to screen

VIA requires use of a speculum and light source, and a trained health-care provider. The provider performs a speculum examination, identifying the SCJ and carefully inspecting the cervix for visual signs suspicious for cancer or pre-cancer. A 3–5% acetic acid solution is liberally applied to the cervix with a large cotton swab. After removing the cotton swab, the provider waits for at least one minute, during which time any areas that became faintly white simply due to inflammation or physiological cell changes (metaplasia) will recede. Acetowhite changes on the cervix that do not recede after one minute are more likely to be associated with cervical pre-cancer or cancer. If these changes are seen in the transformation zone and have well-defined borders, they are considered a positive result (see Chapter 1, section 1.2.4, and/or the glossary, for a description of the transformation zone). If no persistent acetowhite changes are noted, a negative result is reported.

For further information on VIA, see Practice Sheet 5.5.



VIA

² Acetic acid is a component of almost all vinegars; vinegar with 3–5% acidity must be used to correctly detect positive lesions.

Figure 5.1: VIA results recorded on labelled drawing

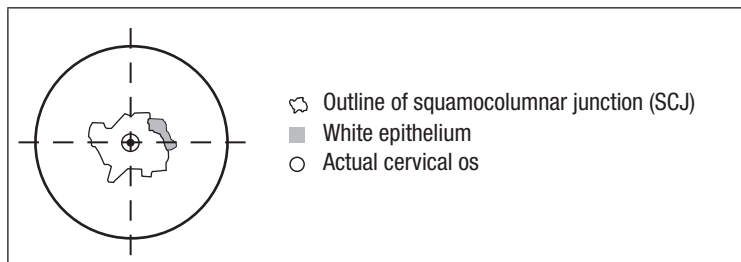

d. Strengths and limitations

VIA testing can detect both early changes and those representing more advanced pre-cancer. The immediate result allows the patient to be offered treatment at the same visit (i.e. the single visit approach). Alternatively, if the patient prefers not to do it immediately or if treatment is not available, then treatment can be done at a subsequent visit soon after. A diagnostic step, such as a colposcopy and/or biopsy, is usually not performed at this time (at the same screening facility), but if the cervix shows any unusual signs or the provider suspects cancer, the patient can be referred for further diagnosis.

VIA is quite inexpensive, utilizes locally sourced supplies (vinegar and cotton), and does not rely on laboratory services. It can be performed by trained providers, with adequate visual acuity, at any level of the health system. Training can be accomplished in a few days using a competency-based approach. VIA is a subjective test and therefore depends on the skills and experience of the provider executing the test. Skills must be used regularly, and refresher courses are recommended. Due to the subjective nature of the test, quality control and quality assurance for VIA is particularly important. This can be achieved through supervision and routine monitoring. For more specific information consult the WHO/PAHO guide: *Monitoring national cervical cancer prevention and control programmes: quality control and quality assurance for visual inspection with acetic acid (VIA)-based programmes* (2013).³

5.3.3 Cytology-based screening methods

a. Description

Cytology-based screening involves taking a sample of cells from the entire transformation zone (see Chapter 1, section 1.2.4, and/or the glossary for a description of the transformation zone). The cells are either fixed on a slide at the facility (Pap

³ Available at: <http://www.who.int/reproductivehealth/publications/cancers/9789241505260/en/>

smear) or placed in a transport medium (liquid-based cytology) and then sent to the laboratory where expert cytotechnologists examine the cells under a microscope. If abnormal cells are seen on microscopic examination, the extent of their abnormality is classified using the Bethesda System (see Annex 5).



A cytology-based screening programme can use one of the two available methods: the conventional Pap smear (or Pap test) or liquid-based cytology (LBC). With conventional cytology, a sample of cells is smeared on a glass slide, and preserved by a fixative agent. LBC was introduced in the mid-1990s; it is a refinement of conventional cytology and is increasingly being used in high- and mid-resource settings. For LBC, instead of smearing the sample onto a slide, it is placed in a container of preservative solution and sent to the laboratory for microscopic examination.

b. Who should be tested?

Cytology-based screening can be used with women in the target population for screening (see section 5.2.5 earlier in this chapter).

c. How to screen

Collection of a cytology sample requires a speculum and adequate lighting to visualize the entire surface of the cervix. The provider takes specimens from the face of the cervix and the endocervix using a spatula or brush and transfers the specimen to a slide (Pap smear) or a preservative solution (LBC). The sample must be appropriately labelled and transported to the laboratory, where skilled personnel are needed to process and interpret it (see Practice Sheet 5.6 for further instructions).

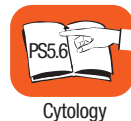

d. Strengths and limitations

Well-implemented cytology programmes can successfully prevent cervical cancer. However, cytology programmes require multiple steps and face significant challenges, especially in low-resource settings. The specimen must be properly collected, fixed/preserved, safely delivered to the laboratory, accurately processed and interpreted, and the results reliably delivered back to the provider. The patient needs to receive the results and have the necessary follow-up or treatment. Hence, there are many opportunities for logistical challenges to interfere with a successful screening programme.

Liquid-based cytology has some advantages over conventional methods. The specimens obtained are more representative of the areas sampled, and there is

generally a lower rate of unsatisfactory specimens and a reduced likelihood of inflammatory or blood cells obscuring the cells that need to be examined on a slide. Furthermore, each specimen takes less time to interpret, and the material collected can also be tested for HPV DNA and other STIs. However, this is a costly technique requiring advanced technology, including a sophisticated laboratory and highly trained technicians. Present evidence does not demonstrate that LBC is any more effective in reducing cancer morbidity and mortality than conventional cytology.

Cytology-based screening, as for all screening methods, requires a well-functioning quality control and quality assurance programme (see Chapter 2 for more information on continuous quality assurance, especially section 2.2.4 on programme monitoring and evaluation).

5.3.4 Comparison of cervical pre-cancer screening methods

Table 5.1 provides a summary and comparison of the procedures, strengths and limitations of the three screening methods for cervical pre-cancer (molecular, visual and cytology-based methods), including both cytology-based methods: Pap smear and LBC.

Table 5.1: Comparison of the characteristics of screening methods for cervical pre-cancer

Method	Procedure	Strengths	Limitations
Molecular screening method: HPV DNA test	<p>The sample is taken by the provider or by the woman herself, stored in a container with appropriate preservative solution and sent to the laboratory (or processed immediately on-site if a new test is used).</p>	<ul style="list-style-type: none"> •Collection of the specimen is simple, allowing the possibility of self-collected specimens. •The assay result is a definite end-point. •If the new test with on-site processing and rapid results is used, a positive result can be followed by an offer of immediate treatment (i.e. single-visit approach). 	<ul style="list-style-type: none"> •It requires proprietary supplies and equipment, which may not be easily accessible. •The unit cost is often high. •Storage of materials needed for tests can be problematic. •In general, the laboratory and specimen transport requirements are complex. •Using an HPV test that is currently available, the result will not be immediately available, requiring the patient to make multiple visits and increasing the risk of loss-to-follow-up.
Visual screening method: Visual inspection with acetic acid (VIA)	<p>A trained provider examines the cervix at least 1 minute after applying 3–5% acetic acid, to visualize cell changes on the cervix.</p>	<ul style="list-style-type: none"> •This method is relatively simple and inexpensive. •The results are available immediately. •VIA can be performed by a wide range of personnel after brief training. •Infrastructure requirements are minimal. •A positive result can be followed by an offer of immediate treatment (i.e. single-visit approach). 	<ul style="list-style-type: none"> •After training, VIA providers need initial supervision and continuing education (refresher retraining) and quality control and quality assurance. •The end point is subjective; there is high variability in the accuracy of results between providers. •VIA is not appropriate for many postmenopausal women.

continued next page

Method	Procedure	Strengths	Limitations
<p>Cytology-based screening method:</p> <p>a. Conventional cytology (Pap smear)</p>	<p>A sample of cervical cells is taken by the provider using a spatula and/or small brush, fixed onto slides and examined by a trained cytotechnician in a laboratory.</p>	<ul style="list-style-type: none"> • This method has proven effectiveness to decrease cervical cancer in the context of a well-functioning system. • It is widely accepted in high-resource countries. • Training and mechanisms for quality control and quality assurance are well established. 	<ul style="list-style-type: none"> • The method is difficult to introduce and maintain. • Systems are needed to ensure timely return and communication of test results and follow-up care for screen-positive women. • Transportation is required for specimens to the laboratory and for results back to the clinic. • Cytology programmes require clinical and laboratory quality control and quality assurance. • Interpretation is subjective. • Results are not immediately available, so multiple visits are required, increasing the risk of loss to follow-up.
<p>b. Liquid-based cytology (LBC)</p>	<p>A sample of cervical cells is taken by the provider with a spatula and/or small brush, immersed in a preservative solution and sent to a laboratory for processing and review by a trained cytotechnician.</p>	<ul style="list-style-type: none"> • Once cytotechnicians are proficient, LBC samples take less time to review. • Samples can also be used for molecular testing (such as for HPV DNA). • Training and mechanisms for quality control and quality assurance are well established. 	<ul style="list-style-type: none"> • Supplies and laboratory facilities for LBC are more expensive than for conventional cytology. • Other limitations are the same as for conventional cytology.

continued next page

See Practice Sheet 5.7 on counselling women after positive screening test results. See Sample Forms 11.1 and 11.2 in Annex 11, relating to screening test results, follow-up and repeat screening.



Counselling: +ve

5.4 Diagnostic tests for detection of cervical pre-cancer

5.4.1 The role of diagnostic tests

A diagnostic or confirmatory test is a medical test performed to aid in the diagnosis or detection of a disease. Because not all women with positive results on cervical screening tests actually have pre-cancer, a subsequent diagnostic test is sometimes used for definitive diagnosis or confirmation of pre-cancer or cancer. Diagnostic tests have major resource implications. They can create significant barriers for women to access services, potentially delaying treatment, and/or increasing the numbers of women who are lost to follow-up and who therefore may never receive treatment for their pre-cancer. Moreover, diagnostic tools can produce false-positive and false-negative results, thus muddying rather than clarifying patient management. Diagnostic tests should not be required before treatment for pre-cancer where the resources are not available or in settlements where there are high rates of loss to follow-up.

5.4.2 Diagnostic tools, training and facilities

Colposcopy, biopsy and endocervical curettage (ECC) are the most commonly used diagnostic tests for cervical pre-cancer. They require a high level of resources and training. If a colposcope, biopsy forceps and an endocervical curette are available, these procedures may be provided at the primary care level by physicians and mid-level providers who have had competency-based training and appropriate supportive supervision. More often, they are performed as outpatient procedures at the secondary care level (district hospital).

5.4.3 Colposcopy

Colposcopy is the examination of the cervix, vagina and vulva with an instrument that provides strong light and magnifies a field, allowing specific patterns in the epithelial (surface) layer and surrounding blood vessels to be examined. This can be done with a colposcope, an expensive, specialized piece of equipment (see Figure 5.2). More recently, it has also been accomplished using specially designed video or digital cameras. Typically, colposcopy is used on patients with positive screening results, to verify the presence, extent and type of pre-cancer or cancer, to guide biopsies of any areas that appear abnormal, and to help determine whether cryotherapy or LEEP is the most appropriate treatment. Colposcopy requires highly trained providers and is not an appropriate screening tool, nor is colposcopy a required step between screening and treatment (see Practice Sheet 5.8 on colposcopy).



Colposcopy

Figure 5.2: Colposcope

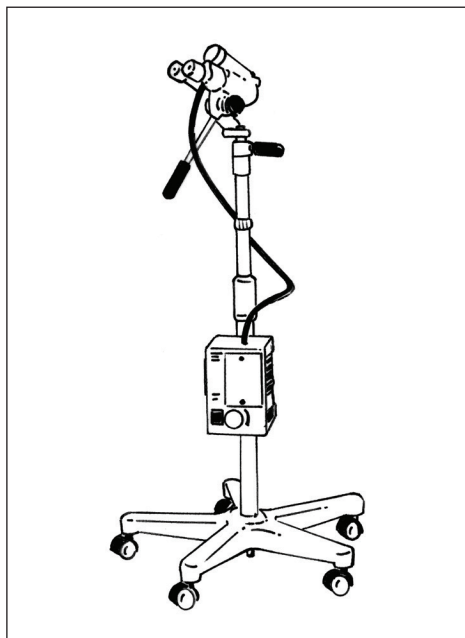

5.4.4 Biopsy

Biopsy is the removal of small samples of abnormal tissue for microscopic examination to achieve a diagnosis. Biopsies can be taken from areas of the cervix that are VIA-positive or from areas that appear suspicious for cancer. If a lesion or abnormal structure of the cervix is not visible to the naked eye, colposcopy can assist in pinpointing the site or sites where one or more biopsies should be taken. Typically, a biopsy is taken from each abnormal area, although random biopsies may be useful under certain circumstances. Special biopsy forceps are required (see Figure 5.3), and training is necessary.

Biopsy is used to determine the degree of abnormality of the cell changes at the cervix and to rule out cancer. After examination, a biopsy is classified as normal, as cervical intraepithelial neoplasia (CIN), or as invasive carcinoma. In some settings, precancerous lesions are classified as low-grade (CIN1) or high-grade (CIN2 and CIN3, collectively referred to as CIN2+) pre-cancer. The classification is based on the thickness of the abnormal epithelium: the deeper the abnormal cells reach from the basement membrane toward the upper layer of cells, the higher the degree

of CIN (see Figure 1.12 in Chapter 1, section 1.3: Natural history of cancer of the cervix, for a graphic depiction of CIN abnormalities). The degree of abnormality informs recommendations for treatment: high-grade lesions (CIN2+) are moderate or severe pre-cancer and are treated, whereas CIN1 is a mild abnormality that typically represents an infection with a low-risk HPV type rather than a true precursor to cervical cancer, and so CIN1 is not usually treated. If invasive cancer is found on biopsy, the patient should be referred for treatment (see Chapter 6).

Using biopsy as a diagnostic tool requires the ability to transport biopsy specimens and the availability of a laboratory and skilled technicians to process and interpret the results, as well as the ability of the patient to return for the results and for the recommended management or treatment. It also requires an ongoing quality control and quality assurance programme to maintain a high level of accuracy in the processing and interpretation of the tissue samples (see Practice Sheet 5.9 on biopsy and ECC).



Figure 5.3: Cervical punch biopsy forceps

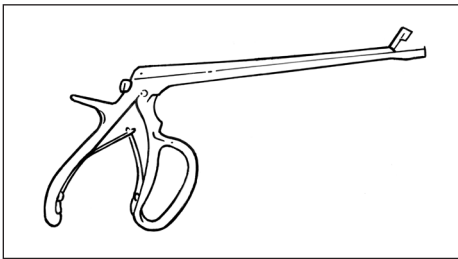

5.4.5 Endocervical curettage

Endocervical curettage (ECC) is a simple procedure that takes just a few minutes: some surface cells are gently scraped from the endocervical canal with a special thin instrument or spatula, and the tissue is placed in a container with a fixative solution and sent to a laboratory for examination. ECC is used in the following circumstances: (1) rare cases when the screening test suggests there may be a pre-cancer or cancer that is not visible with colposcopy, leading the provider to suspect that the lesion is hidden inside the cervical canal; (2) if the squamocolumnar junction cannot be fully visualized in the face of an already suspected lesion; (3) if the Pap smear revealed a glandular lesion, which usually arises from the columnar epithelium inside the canal; and (4) if screening and/or colposcopy were not adequate because the transformation zone was not seen in its entirety and cancer is suspected.

In many locations, an endocervical cytobrush specimen may be used as an equivalent approach instead of ECC (see Practice Sheet 5.9).



Biopsy and ECC

As previously noted for biopsies, after performing an ECC, transport of the specimen, interpretation, and communication of the results to the patient are vital to successful programmes. The provider needs to inform the patient when the results will be ready and ask her to return as soon as feasible to discuss the results. At this return visit, based on the biopsy and/or ECC results, treatment options should be discussed and performed immediately, if possible. Women who do not return as requested should be contacted, given their results and advised about what, if any, treatment they need.

See Chapters 3, 6 and 7 for additional information about counselling, providing a woman with positive biopsy results, and ensuring that she receives appropriate management or referral.

5.4.6 Special situations related to colposcopy, biopsy and endocervical curettage

a. The entire transformation zone is not visible

In this case, ECC should be performed. If this is not possible, and the screening test revealed a possible high-grade lesion, then women should be referred for LEEP or cold knife conization (CKC). In postmenopausal women, the entire transformation zone may not be visible.

b. The woman is pregnant

Pregnancy is not the ideal time to perform a screening test. However, if a screening test is done during pregnancy and abnormal results are found, or if a lesion is noted on speculum examination, the patient should be referred for colposcopy. Taking biopsies during pregnancy can cause significant bleeding. Therefore, if colposcopy is not suspicious for invasive cancer, the patient can be given an appointment to return at 6–12 weeks postpartum for colposcopic re-evaluation and possible biopsy. If cancer is suspected, she should be referred immediately to a specialist at a tertiary care hospital.

c. The woman is living with HIV

Management of abnormalities, including colposcopy and biopsy, should not be modified on the basis of a woman's HIV status. During the healing process after any procedure, women living with HIV might have increased viral shedding. In counselling, it is very important for the provider to stress that the patient should discuss this with her partner(s) and abstain from intercourse until healing has occurred.

5.4.7 Comparison of methods for diagnosis of cervical pre-cancer

Table 5.2 provides a summary and comparison of the procedures, strengths and limitations of the three diagnostic methods for cervical pre-cancer: colposcopy, biopsy and ECC.

Table 5.2: Comparison of the characteristics of diagnostic methods for cervical pre-cancer

Method	Procedure	Strengths	Limitations
Colposcopy	The cervix, vagina and vulva are examined with a colposcope (or similar device), which provides excellent light and magnifies a field.	<ul style="list-style-type: none"> •The cellular patterns and surrounding blood vessels can be examined. •This procedure can be used to guide biopsy of abnormal areas. 	<ul style="list-style-type: none"> •Colposcopy is resource intensive; it requires provider training, specialized equipment and pathology services. •It should not be used as a screening method. •If the procedure is not readily available, this can create bottlenecks in the system, leading to patients being lost to follow-up.
Biopsy	A small sample of abnormal tissue is removed for microscopic examination, to reach diagnosis.	<ul style="list-style-type: none"> •Biopsy allows histological confirmation of a lesion, including ruling in or out cervical cancer. 	<ul style="list-style-type: none"> •Biopsy is resource intensive; it requires provider training, specialized equipment and pathology services.
Endocervical curettage (ECC)	Surface cells from the endocervical canal are gently scraped then sent to a laboratory for evaluation.	<ul style="list-style-type: none"> •ECC provides a sample of cells from an area of the cervix that is not visible to the naked eye or with colposcopy. 	<ul style="list-style-type: none"> •ECC is resource intensive; it requires provider training, specialized equipment and pathology services. •It may cause cramping. •Results can be difficult to interpret if tissue is fragmented.

See Sample Forms 11.3 and 11.4 in Annex 11, relating to diagnostic evaluations.



Sample documents

5.5 Treatment options for cervical pre-cancer

Women with pre-cancer must receive effective treatment, which can usually be provided by trained primary care providers at primary care facilities (i.e. health centres), in contrast to treatment for suspected or confirmed invasive cancer, which

requires specialist medical providers at higher-level facilities (i.e. hospitals). In the context of a screen-and-treat approach, treatment follows a positive screening test without diagnostic confirmation.

Treatment aims to destroy or remove areas of the cervix identified as pre-cancer. Treatment methods may be ablative (destroying abnormal tissues by burning or freezing) or excisional (surgically removing abnormal tissues). With ablative methods, no tissue specimen is obtained for further confirmatory histopathological examination.

Each treatment method has eligibility criteria that should be met before proceeding with treatment. In this section, we will discuss use of cryotherapy, loop electrosurgical excision procedure (LEEP) and cold knife conization (CKC). Other forms of therapy do exist, such as laser excision or ablation, but are not as widely available and thus will not be addressed here.

Hysterectomy is rarely an appropriate means to treat pre-cancer. Unless there are other compelling reasons to remove the uterus, hysterectomy should not be performed for pre-cancer.

The choice of treatment will depend on:

- the benefits and harms of each method
- the location, extent and severity of the lesion
- the cost and resources required to provide treatment
- the training and experience of the provider.

Regardless of the treatment method recommended by the provider, the woman needs information about the procedure so that she can make an informed choice. Consent from the patient is needed prior to the procedure, but it can be given verbally (see Practice Sheet 5.1).



Informed consent

If cancer is suspected: If a patient has a cervical abnormality that looks suspicious for cancer, the patient should NOT be treated with cryotherapy, LEEP or CKC. The appropriate next step for her is a cervical biopsy to confirm or rule out a diagnosis of cancer (see Chapter 6). If the provider has the appropriate training and equipment, he or she can perform the biopsy. If not, the provider should refer the patient for prompt further evaluation.

5.5.1 Cryotherapy

Cryotherapy eliminates precancerous areas on the cervix by freezing (an ablative method). It involves applying a highly cooled metal disc (cryoprobe) to the cervix and

freezing the abnormal areas (along with normal areas) covered by it (see Figure 5.4). The supercooling of the cryoprobe is accomplished using a tank with compressed carbon dioxide (CO₂) or nitrous oxide (N₂O) gas. Cryotherapy can be performed at all levels of the health system, by health-care providers (doctors, nurses and midwives) who are skilled in pelvic examination and trained in cryotherapy. It takes about 15 minutes and is generally well tolerated and associated with only mild discomfort. It can, therefore, be performed without anaesthesia. Following cryotherapy, the frozen area regenerates to normal epithelium.

Figure 5.4: Position of cryoprobe on the cervix and ice forming

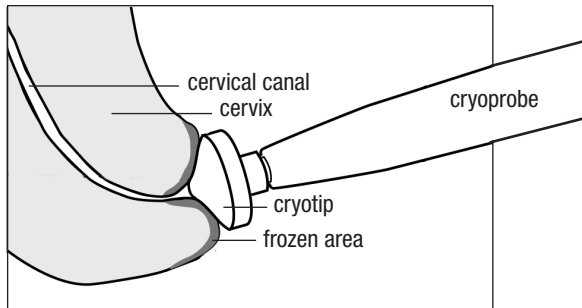

Eligibility criteria: Screen-positive women (such as with VIA screening) or women with histologically confirmed CIN2+ are eligible for cryotherapy if the entire lesion and squamocolumnar junction are visible, and the lesion does not cover more than three quarters of the ectocervix. If the lesion extends beyond the cryoprobe being used, or into the endocervical canal, the patient is not eligible for cryotherapy. The patient is not eligible for cryotherapy if the lesion is suspicious for invasive cancer.

Post procedure: It takes a month for the cervical tissue to regenerate. The patient should be advised that during this time she may have a profuse, watery discharge and she should avoid sexual intercourse until all discharge stops, or use a condom if intercourse cannot be avoided.

For further information on cryotherapy, see Practice Sheet 5.10 and consult *WHO guidelines: use of cryotherapy for cervical intraepithelial neoplasia* (2011).⁴



5.5.2 Loop electrosurgical excision procedure

LEEP is the removal of abnormal areas from the cervix using a loop made of thin wire powered by an electrosurgical unit. The loop tool cuts and coagulates at the same

⁴ Available at: <http://www.who.int/reproductivehealth/publications/cancers/9789241502856/en/>

time, and this is followed by use of a ball electrode to complete the coagulation (see Figure 5.5). LEEP aims to remove the lesion and the entire transformation zone. The tissue removed can be sent for examination to the histopathology laboratory, allowing the extent of the lesion to be assessed. Thus, LEEP serves a double purpose: it removes the lesion (thus treating the pre-cancer) and it also produces a specimen for pathological examination. The procedure can be performed under local anaesthesia on an outpatient basis and usually takes less than 30 minutes. However, following LEEP, a patient should stay at the outpatient facility for a few hours to assure bleeding does not occur.

Figure 5.5: LEEP of an ectocervical lesion with one pass: excision of the lesion with wire electrode and coagulation with ball electrode

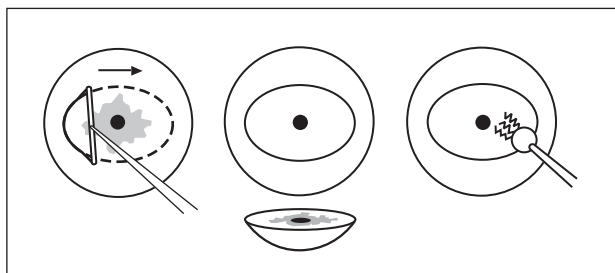

LEEP is a relatively simple surgical procedure, but it should only be performed by a trained health-care provider with demonstrated competence in the procedure and in recognizing and managing intraoperative and postoperative complications, such as haemorrhage; e.g. a gynaecologist. LEEP is best carried out in facilities where back-up is available for management of potential problems; in most cases, this will limit LEEP to at least the secondary-level facilities (i.e. district hospitals).

Eligibility criteria: Screen-positive women (such as with VIA screening), or women with histologically confirmed CIN2+ are eligible for LEEP if the lesion is not suspicious for invasive cancer.

Post procedure: The patient should be advised to expect mild cramping for a few days and some vaginal discharge for up to one month. Initially, this can be bloody discharge for 7–10 days, and then it can transition to yellowish discharge. It takes one month for the tissue to regenerate, and during this time the patient should avoid sexual intercourse or use a condom if intercourse cannot be avoided.

See Practice Sheet 5.11 for further details on LEEP.



5.5.3 Cold knife conization

CKC is the removal of a cone-shaped area from the cervix, including portions of the outer (ectocervix) and inner cervix (endocervix) (see Figure 5.6). The amount of tissue removed will depend on the size of the lesion and the likelihood of finding invasive cancer. The tissue removed is sent to the pathology laboratory for histopathological diagnosis and to ensure that the abnormal tissue has been completely removed. A CKC is usually done in a hospital, with the necessary infrastructure, equipment, supplies and trained providers. It should be performed only by health-care providers with surgical skill – such as gynaecologists or surgeons trained to perform the procedure – and competence in recognizing and managing complications, such as bleeding. The procedure takes less than one hour and is performed under general or regional (spinal or epidural) anaesthesia. The patient may be discharged from hospital the same or the next day.

Figure 5.6: Removal of a cone-shaped area of the cervix

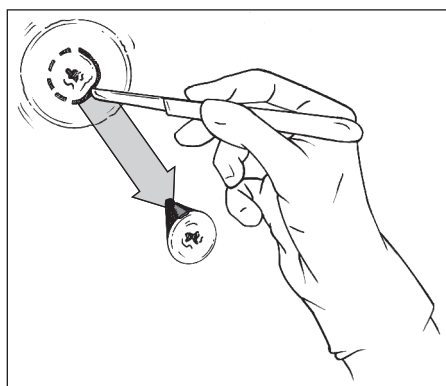

Eligibility criteria: CKC should be reserved for cases that cannot be resolved with cryotherapy or LEEP. It should be considered in the presence of glandular pre-cancer or microinvasive cancer lesions of the cervix (see Chapter 6).

Post procedure: Following CKC, patients may have mild cramping for a few days and a bloody vaginal discharge, transitioning into a yellow discharge for 7–14 days. It takes 4–6 weeks for the cervix to heal (depending on the extent of the procedure) and during this time the patient should avoid sexual intercourse or use a condom if intercourse cannot be avoided.

See Practice Sheet 5.12 for more information on CKC.



5.5.4 Comparison of methods for treatment of cervical pre-cancer

Table 5.3 provides a summary and comparison of the procedures, strengths and limitations of the three treatment methods for cervical pre-cancer: cryotherapy, LEEP and CKC.

Table 5.3: Comparison of the characteristics of treatment methods for cervical pre-cancer

Method	Procedure	Strengths	Limitations
Cryotherapy	A highly cooled metal disc is applied to the cervix for the purpose of freezing and therefore destroying precancerous lesions, with subsequent regeneration to normal epithelium.	<ul style="list-style-type: none"> •The equipment is simple and relatively inexpensive. •It can be performed by trained and competent physicians and nonphysicians. Training takes a few days. •Cryotherapy is an outpatient procedure, and can be performed in a primary care setting. •It is fast; about 15 minutes for the double-freeze method. •Anaesthesia is not required. •Electricity is not required. •In the context of a screen-and-treat approach, a screen-positive result can be followed by an offer of treatment at the same visit, maximizing treatment coverage and reducing loss to follow-up. 	<ul style="list-style-type: none"> •No tissue sample will be available for histopathological examination. •It requires a reliable supply of carbon dioxide or nitrous oxide. •It causes profuse watery discharge for up to one month.
Loop electrosurgical excision procedure (LEEP)	Abnormal areas are removed from the cervix using a loop made of thin wire powered by an electrosurgical unit.	<ul style="list-style-type: none"> •A specimen will be obtained from the procedure for histopathological examination, which allows invasive cancer to be ruled out. •It can be performed on an outpatient basis at a secondary care level. •It is fast (10–15 minutes) and technically simple for a trained provider to perform. •In the context of a screen-and-treat approach, a screen-positive result can be followed by an offer of treatment at the same visit, maximizing treatment coverage and reducing loss to follow-up. 	<ul style="list-style-type: none"> •LEEP requires intensive training. •It requires a facility where treatment is available in case of complications. •The histology specimen can have charred borders, making lesion margins difficult to interpret. •The equipment needed is quite sophisticated and needs maintenance. •LEEP requires electricity. •It requires local anaesthesia.

continued next page

Method	Procedure	Strengths	Limitations
Cold knife conization (CKC)	A cone-shaped area is removed from the cervix, including portions of the outer and inner cervix.	<ul style="list-style-type: none"> • A single surgical specimen, with “clean” edges is removed, which facilitates the evaluation of the margins for complete excision of the diseased area, and allows invasive cancer to be diagnosed or ruled out. 	<ul style="list-style-type: none"> • CKC requires spinal or general anaesthesia. • It requires a highly skilled, surgically trained provider. • It requires an operating theatre.

5.6 Possible complications and follow-up after treatment

5.6.1 Possible complications

All three treatment modalities may have similar complications in the days following the procedure. All of these complications may be indications of continuing bleeding from the cervix or vagina or an infection that needs to be treated. See Annex 12 for information on treatment of cervical infections and pelvic inflammatory disease.



Patients should be advised that if they have any of the following symptoms after cryotherapy, LEEP or CKC, they should seek care at the closest facility without delay:

- bleeding (more than menstrual flow)
- abdominal pain
- foul-smelling discharge
- fever.

5.6.2 Follow-up after treatment

A follow-up visit including cervical cancer screening is recommended 12 months after treatment to evaluate the woman post-treatment and detect recurrence. If this follow-up rescreen is negative, the woman can be referred back to the routine screening programme.

An exception is if the patient has a histopathological result at the time of treatment that indicates CIN3 or adenocarcinoma in situ (AIS) based on a specimen from LEEP or CKC. In this case, rescreening is recommended every year for three years. If these rescreens are negative, she is then referred back to the routine screening programme.

If the patient treated for pre-cancer has a positive screen on her follow-up visit (indicating persistence or recurrence of cervical pre-cancer), retreatment is needed.

If the initial treatment was with cryotherapy, then retreatment should be performed using LEEP or CKC, if feasible.

If a histopathological result from a specimen obtained from a punch biopsy, LEEP or CKC procedure indicates cancer, it is critical that the patient be contacted and advised that she must be seen at a tertiary care hospital as soon as possible.

5.7 Linking screening and treatment in practice

For cervical cancer prevention to be effective, positive screening must be linked with effective treatment. WHO has considered the evidence for two approaches to linking screening and treatment for pre-cancer of the cervix:

1. Screen, diagnose and treat
2. Screen-and-treat.

5.7.1 Screen, diagnose and treat approach

The approach involves conducting the screening test and following up on a positive result by using diagnostic steps, such as colposcopy and biopsy, to histologically confirm the pre-cancer diagnosis and its severity. Treatment is then based on the results of the histological confirmation. For example, if a woman has histologically confirmed CIN2+, she receives treatment (see section 5.5 and Box 5.1), but if cancer is found on histology, she is referred to the tertiary care hospital (see Chapter 6).

a. Recommendations for treatment in the screen, diagnose and treat approach

Box 5.1 presents WHO's evidence-based summary treatment recommendations for histologically confirmed CIN2+. These recommendations have been derived from WHO guidelines for treatment of cervical intraepithelial neoplasia 2–3 and adenocarcinoma in situ (2014) – please see that publication for the complete recommendations with remarks and considerations.⁵ These recommendations are meant for health-care providers and to assist programme managers in designing cervical cancer prevention and control strategies.

⁵ Available at: http://www.who.int/reproductivehealth/publications/cancers/treatment_CIN_2-3/en/

Box 5.1: Summary treatment recommendations

For women with histologically confirmed CIN2+ disease, regardless of HIV status

The expert panel recommends (STRONG recommendation):

1. Use cryotherapy over no treatment.
2. Use loop electrosurgical excision procedure (LEEP) over no treatment.
3. Use cold knife conization (CKC) over no treatment.

The expert panel suggests (CONDITIONAL recommendation):

4. Use either cryotherapy or LEEP in women for whom either cryotherapy or LEEP is appropriate to use and available.

The expert panel recommends (STRONG recommendation):

5. Use cryotherapy over CKC in women in whom either cryotherapy or CKC is appropriate to use.
6. Use LEEP over CKC in women in whom either LEEP or CKC is appropriate to use.

For women with histologically confirmed AIS disease, regardless of HIV status

The expert panel suggests (CONDITIONAL recommendation):

7. Use CKC over LEEP.

5.7.2 Screen-and-treat approach

Adding a diagnostic step after screening, before treatment of pre-cancer, can result in high loss to follow-up because additional patient visits are required as well as a longer time interval between screening and treatment. To reduce such loss to follow-up, the screen-and-treat approach has been developed and this strategy is increasingly being adopted worldwide.

The screen-and-treat approach utilizes a screening test that gives either immediate or rapid results that can be followed closely by treatment of those women who screen positive for pre-cancer. Ideally, the treatment can occur on the same day and at the same location (i.e. the single visit approach). If this is not possible or the patient declines, then treatment can be offered shortly after screening at an arranged time and location easily accessible to the patient. The screen-and-treat approach eliminates the extra visits and time required for the diagnostic step.

A limitation to the screen-and-treat approach is that the lack of a diagnostic step can result in false-positive results and overtreatment. However, concerns about overtreatment must be weighed against the low morbidity associated with treatment

using cryotherapy and the overall benefit of ensuring higher rates of treatment. Another concern about the screen-and-treat approach is that when cryotherapy is done immediately after positive VIA or HPV results, no tissue sample would be available if needed for histological examination at a later time.

To try to reduce overtreatment while still retaining the benefits of the screen-and-treat approach, another strategy is to follow an initial positive screening test with a second test, and then only treat the patient if both tests are positive. For instance, when HPV testing is used as a single screening test in a screen-and-treat approach, women who have a positive HPV test will be treated. Some of these women with a positive HPV test had pre-cancer and were appropriately treated, but some did not have pre-cancer and hence were unnecessarily treated (overtreatment). In a strategy that uses a second test, such as VIA, a woman who is HPV positive would then undergo VIA, and would only be treated if the VIA is also positive. If the VIA is negative, she would not be treated, but would be followed up with another HPV test in 12 months. However, adding a second test does not always result in a better outcome, since false-negative results can occur on the second test. If the first test was in fact a true positive and the second test was a false negative, then the woman would not be treated even though she had pre-cancer. Hence the use of a second test must be carefully considered. In the case of an initial test being positive and a second test being negative, another screen 12 months later may be recommended.

a. Recommendations for treatment in the screen-and-treat approach

The following recommendations for screening and treatment of pre-cancer of the cervix have been derived from the WHO guidelines for screening and treatment of precancerous lesions for cervical cancer prevention (2013).⁶ These recommendations are to help health-care providers understand, explain and treat pre-cancer and to assist programme managers in designing cervical cancer prevention and control programmes. Easy-to-follow screen-and-treat algorithms are available as flowcharts in Annexes 7–9 and detailed recommendations are in the full published guidelines, available online. Box 5.2 presents WHO's evidence-based screen-and-treat summary recommendations, which should be used when making case management decisions. Please see the full publication for the complete recommendations with remarks and considerations.

Programme managers should also consult Chapter 2, which contains information about many other factors to consider when creating a cervical cancer prevention and control programme.

⁶ Available at: http://www.who.int/reproductivehealth/publications/cancers/screening_and_treatment_of_precancerous_lesions/en/

Box 5.2: Screen-and-treat strategy summary recommendations

These recommendations apply to all women regardless of HIV status, but specific recommendations for women living with HIV have also been developed (see Annex 9).

The expert panel recommends⁷ against the use of cold knife conization (CKC) as a treatment in a screen-and-treat strategy. Therefore, all screen-and-treat strategies below involve treatment with cryotherapy, or loop electrosurgical excision procedure (LEEP) when the patient is not eligible for cryotherapy.

The expert panel suggests:

- Use a strategy of screen with an HPV test and treat, over a strategy of screen with VIA and treat. In resource-constrained settings, where screening with an HPV test is not feasible, the panel suggests a strategy of screen with VIA and treat.
- Use a strategy of screen with an HPV test and treat, over a strategy of screen with cytology followed by colposcopy (with or without biopsy) and treat. However, in countries where an appropriate/high-quality screening strategy with cytology followed by colposcopy already exists, either an HPV test or cytology followed by colposcopy could be used.
- Use a strategy of screen with VIA and treat, over a strategy of screen with cytology followed by colposcopy (with or without biopsy) and treat. The recommendation for VIA over cytology followed by colposcopy can be applied in countries that are currently considering either programme or countries that currently have both programmes available.
- Use a strategy of screen with an HPV test and treat, over a strategy of screen with an HPV test followed by colposcopy (with or without biopsy) and treat.
- Use either a strategy of screen with an HPV test followed by VIA and treat, or a strategy of screen with an HPV test and treat.
- Use a strategy of screen with an HPV test followed by VIA and treat, over a strategy of screen with VIA and treat.
- Use a strategy of screen with an HPV test followed by VIA and treat, over a strategy of screen with cytology followed by colposcopy (with or without biopsy) and treat.
- Use a strategy of screen with an HPV test followed by VIA and treat, over a strategy of screen with an HPV test followed by colposcopy (with or without biopsy) and treat.

⁷ The expert panel includes all members of the WHO Steering Group, the Guideline Development Group (GDG), and the External Review Group (ERG). See full guidelines for further details: http://www.who.int/reproductivehealth/publications/cancers/screening_and_treatment_of_precancerous_lesions/en/

6

CHAPTER 6. DIAGNOSIS AND TREATMENT OF INVASIVE CERVICAL CANCER

Chapter 6. Diagnosis and treatment of invasive cervical cancer

Key points

- Women diagnosed with early invasive cervical cancer can usually be cured with effective treatment.
- It is important for health-care providers at all levels to be able to recognize and promptly manage common symptoms and signs of cervical cancer.
- The definitive diagnosis of invasive cervical cancer is made by histopathological examination of a biopsy.
- Women with invasive cervical cancer benefit from referral for treatment at tertiary-level cancer facilities.
- Treatment options include surgery, radiotherapy and chemotherapy; these may be used in combination.
- Patients should be made aware of the potential side-effects of treatment, such as infertility, menopause, discomfort or pain with intercourse and possible bowel or bladder changes.
- Patients need to be informed that they will need long-term follow-up and contact with the cancer unit where they received their treatment.
- Tertiary-level providers should send complete written records of the treatment and ongoing care plan to providers closest to the patient's home who will be charged with facilitating her follow-up care.
- If left untreated, invasive cervical cancer is almost always fatal.

About this chapter

This chapter is based on the following WHO guidelines:

Surgical care at the district hospital. Geneva: WHO; 2003 (<http://www.who.int/surgery/publications/en/SCDH.pdf>).

Comprehensive cervical cancer prevention and control: a healthier future for girls and women: WHO guidance note. Geneva: WHO; 2013 (<http://www.who.int/reproductivehealth/publications/cancers/9789241505147/en/>).

Implementation tools: package of essential noncommunicable (PEN) disease interventions for primary health care in low-resource settings. Geneva: WHO; 2014 (<http://www.who.int/nmh/ncd-tools/en/>).

The provider at first or second health care levels may have diagnosed invasive cancer in the patient and referred her to a tertiary-level facility. This provider is responsible for making a link between the tertiary care level (where the patient undergoes staging and treatment for invasive cancer) and the patient herself, her family and her community. This chapter is not primarily intended to be used by tertiary-level providers, but rather to help first- and second-level providers to understand how cervical cancer is managed, to explain it to the patient and her family, and to communicate with carers at tertiary and community levels. In addition, the providers will be responsible for identifying and managing side-effects and complications of treatment, and referring the patient back to the treatment facility when necessary.

The main purpose of this chapter is to help primary- and secondary-level providers understand how cervical cancer is diagnosed, how it may be managed, and how to explain the process to the patient and her family, as well as how best to communicate with tertiary-level and community-based health-care providers. This is covered in section 6.2, in addition to some suggestions for tertiary-level providers on how to talk with a patient in their care, in nontechnical language, when discussing the implications of a diagnosis of cervical cancer.

This chapter continues with an explanation of cervical cancer staging (section 6.3), and goes on to give an overview of issues surrounding cervical cancer treatment (section 6.4). Section 6.5 provides short descriptions of each type of treatment that may be available at tertiary-level facilities, in order to help providers explain these treatments to patients. Section 6.6 describes the special considerations when cervical cancer must be managed during pregnancy and in women living with HIV. Finally, if a point is reached when the treatment is determined to be ineffective and the patient's illness is not curable, section 6.7 of this chapter suggests how tertiary-level providers can discuss this with the patient and her chosen companions, including how to explain that it would be better for her to be cared for at home during the time she has left, by her family and community, with the support of providers at all levels, as needed.

The practice sheets for this chapter contain helpful, nontechnical language for providers at all levels to use when communicating with a patient (and those she chooses to be with her) about her illness and her treatment. The specific topics for discussion include: symptoms and diagnosis, possible treatments at the tertiary-care hospital and their side-effects, prognosis, needed medical follow-up and how the patient can care for herself at all stages with help from her family, the community and her primary care providers. There are also practice sheets on each of the main treatment methods: hysterectomy, pelvic teletherapy and brachytherapy.

Betty's story

Betty, aged 42, has five children. She went to her primary care provider when, after some months of vaginal discharge, she started having heavy vaginal bleeding after intercourse. The nurse, who had previously seen Betty for other health problems, gave her some pills and asked her to return if they did not have any effect. The bleeding and discharge did not improve, and Betty returned with her partner to the clinic. All the nurse could do was to conduct a vaginal examination without a speculum; when she introduced a finger into Betty's vagina, she felt a hard, irregular mass at the top. Now, the nurse informed Betty and her partner that they needed to go to the secondary care hospital for a gynaecologic evaluation and that she would make an appointment for her as soon as possible.

At the hospital, Betty was examined by the intern, who noted a large cauliflower-like (fungating) mass at the top of the vagina; she immediately suspected cancer so she took a confirmatory biopsy and ordered other tests. The biopsy confirmed the intern's suspicion of cancer and the blood tests showed that Betty was quite anaemic. Betty received a blood transfusion and was urgently referred to the specialists at the tertiary care hospital.

After examining Betty and doing additional tests, doctors explained to her and her partner that she had a cancer which had spread to the tissue around her cervix but had no involvement of other organs or distant metastases. They explained that they believed she had a good chance of being cured by five weeks of daily radiotherapy treatments on an outpatient basis. They explained how radiotherapy works and described the external and internal radiotherapy treatments they could provide. She was told that as a result of radiotherapy she would most likely enter her menopause, meaning that she would have no more menstrual periods, she would be unable to become pregnant (infertility), and she could expect to experience hot flushes. She and her partner might also find sexual intercourse uncomfortable. The doctors explained that they would help to relieve Betty's symptoms, and they responded to Betty's and her partner's questions and made sure Betty understood what they had explained. The doctors told her she could start treatments very soon, if she was ready, but they explained that before starting she needed to sign an informed consent form provided by the hospital. They reassured her that signing this form would not prevent her from changing her mind for any reason at any time before or during the treatments. She chose to start treatment and her partner supported her decision and promised to help her get through this time.

continued next page

Betty rented a room near the hospital and her partner returned home to care for their children and paid frequent short visits. Betty was able to tolerate her treatments and after five weeks she was able to return home. Her partner and older children helped with household duties until she recovered.

The specialists sent a detailed report to the regional hospital doctor who was charged with providing follow-up care for Betty every three months, and more often if needed. Her doctor communicated with the treating specialist about emerging problems during follow-up and how to manage them. Betty's side-effects were just as expected and she received advice on how to manage them. Betty's cancer showed no signs of recurrence during two years' follow-up.

At the end of two years, Betty returned to the tertiary care hospital where she had been treated and saw the specialist for a thorough examination and discussion. Here it was confirmed that there was no recurrence and Betty was told that she only needed yearly examinations as long as she did not have any new symptoms. She was given a brochure with all this information and a detailed note to give to her primary care doctor.

Please note that Chapter 7 and its practice sheets provide detailed information on palliative care and should be consulted as needed in conjunction with the information in this chapter.

6.1 Presentation and diagnosis of cervical cancer

Occasionally, a patient who attends a pre-cancer screening clinic will be noted to have a visible abnormality on her cervix. If a trained provider and necessary equipment and supplies are available at the clinic, a biopsy can be taken and sent to the laboratory for diagnosis. If this is not feasible, the patient will be referred to a secondary-level facility for biopsy and diagnosis (see Practice Sheet 5.9 on biopsy and endocervical curettage).

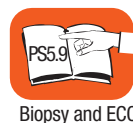

More often, a woman will present to her primary care provider with abnormal symptoms suspicious for cervical cancer. If the primary care provider is trained and has the needed equipment and supplies she may take a biopsy, but in most cases she will refer the patient to the secondary care hospital to be examined by a gynaecologist who will take the biopsy and send it to the laboratory for histopathological examination. If positive results are returned, the patient will be referred to a tertiary care hospital to see a specialist for further testing and treatment.¹

¹ Please also refer to WHO's 2014 publication *Implementation tools: package of essential noncommunicable (PEN) disease interventions for primary health care in low-resource settings*, available at: <http://www.who.int/nmh/ncd-tools/en/>

Unfortunately, many women may remain asymptomatic until the disease is advanced, especially women who are not currently sexually active.

Presenting symptoms of invasive cervical cancer by level of severity (early and advanced) are listed in Table 6.1 (see also section 6.3, including Table 6.2 and Figure 6.1, for more information on the FIGO staging system).

Table 6.1: Symptoms of invasive cervical cancer

Early	<ul style="list-style-type: none"> • vaginal discharge, sometimes foul-smelling • irregular bleeding (of any pattern) in women of reproductive age • postcoital spotting or bleeding in women of any age, even young women • postmenopausal spotting or bleeding • in the case of abnormal perimenopausal bleeding, cervical cancer should always be considered, particularly if the bleeding fails to respond to appropriate treatment
Advanced	<ul style="list-style-type: none"> • urinary frequency and urgency • backache • lower abdominal pain • severe back pain • weight loss • decreased urine output (from obstruction of the ureters, or renal failure) • leakage of urine or faeces through the vagina (due to fistulae) • swelling of the lower limbs • breathlessness (due to anaemia or, rarely, lung metastases or effusion)

For more information on managing a patient who has symptoms that may be due to cervical cancer, see Practice Sheet 6.1.



Symptoms: maybe due to cancer

6.2 The role of the health-care provider

6.2.1 Provider roles at the primary and secondary levels

When a patient experiences any of the abnormal symptoms listed in Table 6.1, she may first discuss her situation with a community health worker or traditional healer. She may be given a remedy and, if symptoms continue, she will likely be advised to consult her primary care provider, often a nurse.

a. When a woman presents at the primary- or secondary-level facility with abnormal symptoms

If a provider at a **primary-level facility** is trained and has all the essential equipment and supplies, she may perform a pelvic examination and take a biopsy of any abnormality noted on the cervix. If the result of the biopsy is invasive cervical cancer, the primary care provider will probably refer the patient directly to the tertiary care hospital for further tests and management. However, many primary care centres

do not have the necessary equipment or lack a trained provider to perform a pelvic examination. Therefore, most often a woman presenting with symptoms will be informed that she needs to see a gynaecologist at the closest secondary-level facility without delay. In rare cases, a patient may present at a primary care centre with severe vaginal haemorrhaging; these patients will probably be sent directly to a tertiary-level facility for evaluation and treatment.

At the secondary-level hospital, the provider who manages patients with abnormal symptoms is advised to first establish or reinforce a trusting relationship and rapport with the patient. The provider will take a full history and perform a thorough examination to determine if there are any cervical lesions and note the presence of any indurations, swellings and other abnormalities in the cervix and the surrounding tissues and organs (see Practice Sheet 5.2).

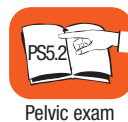

If appropriate for the patient, pregnancy and HIV tests will also be done before taking a biopsy of a cervical lesion at the secondary care facility. If both tests are negative and an experienced provider and needed equipment are available, a biopsy will be taken and sent to the laboratory for histopathological examination. If, on the other hand, the woman is pregnant and/or is living with HIV, it is advisable to send her to the tertiary-level hospital to have the biopsy taken and, depending on results, have her treatment planned.

The histopathology of the biopsy specimen will confirm or rule out the diagnosis of cervical cancer, which is an essential step before more extensive examinations are done. If the biopsy is positive for cancer, the patient will again be referred, this time from the secondary- to the tertiary-level facility for further tests and investigations and determination of the most appropriate available treatment (see section 6.2.2 on the roles of tertiary-level providers).

Providers should keep in mind that the biopsy results may also identify a few other possible diagnoses for women with similar symptoms (this process is called differential diagnosis). Other possibilities include infectious diseases, such as herpes, which can change the appearance of the cervix and be confused with early cervical cancers, or metastatic cancer from other sites, including from the lining of the uterus (i.e. uterine or endometrial cancer).

b. When a woman is diagnosed with cervical cancer at the primary- or secondary-level facility

When a definitive diagnosis of cervical cancer is reported, the provider who performed the biopsy needs to gently explain the diagnosis to the woman, allowing

time for her to reflect and understand the seriousness of her disease and ask questions. If she is not already at a tertiary care hospital, she will be referred to the closest specialist hospital, where cancer specialists and sophisticated equipment are available to provide treatment. See Practice Sheets 6.2 and 6.3 for further advice on communicating with patients at this stage.



Counseling:
Cancer diagnosis



What will happen
at the hospital

c. When a woman is discharged from hospital after treatment

An additional role for primary and secondary care providers is to provide care and support to women who have been discharged from the hospital either because treatment was successful and she can begin her recovery, or because treatment was not effective and she is returning home for palliative care. The primary and secondary care providers, if possible, will maintain communication with the tertiary-level specialists and conduct prescribed periodic follow-up examinations, identify and manage side-effects and complications secondary to the disease and/or treatment, and, if needed and possible, refer the patient back to the treatment facility.

If the patient is receiving palliative care, the primary and secondary care providers are her main medical support, in consultation with the specialists at the tertiary care facility and, if desired, with traditional medicine providers. This medical support may include maintaining the patient free of pain and treating many of the common problems developed by patients who have been treated for cancer.

d. Other important roles

Primary- and secondary-level providers also have other important collaborative roles as members of the cervical cancer team. These may include:

- educating and training communities;
- training community health workers, including to dispense medicines for pain-relief (if this is permitted by the national regulations);
- training staff who have recently joined the care team;
- instructing the patient's close family and friends on how to provide special care to prevent serious symptoms and treat these if they occur;
- establishing links between the patient and her family and faith-based or other assistance agencies that may provide broad nonmedical support, including donations of funds, food and nonmedical supplies;
- aiding the patient and her family as much as possible during the terminal stages of disease;
- doing home visits during severe or terminal phases of the disease, if feasible.

For further details on palliative care, see Chapter 7 and its practice sheets.

6.2.2 Understanding provider roles at the tertiary level

At the tertiary care hospital, there are cancer care and management specialists, and advanced testing and treatment options are available. This section is mainly intended to help primary- and secondary-level providers understand and explain what a patient can expect when she is referred to a tertiary-level facility.

Tertiary-level provider roles include the following:

- Assess the stage of the woman's cancer using a complete physical examination and a series of tests; this will inform the best management for the patient including treatment and follow-up (see section 6.3 for further information on cancer staging as well as comments on how tertiary care providers can talk about this with the patient).
- Determine the best treatment(s) available for the patient at the facility, taking into account the availability of specialists and equipment.
- Monitor the patient during and after treatments to determine the effect of the treatment on the cancer and to manage any side-effects.
- If communication between local and tertiary care providers is possible, the specialist may assist the local providers in the patient's community to offer follow-up care after the patient is discharged from hospital. If needed, the specialist will provide advice on additional tests to be ordered and on management of side-effects and other emerging problems.
- Provide continuity of support for follow-up care for patients discharged to receive home-based palliative care; this support may take place via telephone, email or other available channels with the primary- and/or secondary-level providers. In some cases, due to severe, intractable symptoms (e.g. pain, severe bleeding), the patient may be referred back to the hospital for additional palliative treatment (see Chapter 7).

6.3 Cervical cancer staging

Cervical cancer staging is undertaken using one of the existing international staging systems to determine the extent of the cervical cancer invasion and the presence or absence of distant metastases. The stage of the patient's cancer is used by the specialists to select and plan the most appropriate available treatment for her (see Annex 10 on cervical cancer treatment by stage).



Treatment
by FIGO stage

At some tertiary-level facilities, speculum, vaginal and rectal examinations and possibly tests to examine the urinary system (cystoscopy) and intestinal system (proctoscopy) may be the only available tools for staging. Based on this limited number of tests, an experienced specialist will know the location of the tumour, whether it is growing outwards or inwards from the tissues of the cervix, its size, its

extension to the tissues next to the cervix and to the uterus and the ligaments holding the uterus in place, as well as to the pelvic walls. Involvement of the urinary bladder and rectum can also be determined.

At most tertiary-level facilities, more advanced tests are also available and will be used to obtain a more detailed description of the disease, which will assist in determining the best treatments available for the patient (see Table 6.2). The assessment can be done under general anaesthesia if the investigations for the full diagnosis and staging are too uncomfortable and/or painful.

Table 6.2: Investigations for staging and treatment for cervical cancer

Mandatory for staging	Supplementary for staging
<ul style="list-style-type: none"> • Speculum, vaginal and rectal examination • Intravenous pyelogram (IVP) or abdominal ultrasound 	<ul style="list-style-type: none"> • Cystoscopy • Proctoscopy • Cone biopsy • Endocervical curettage or smear • Chest X-ray • Skeletal X-ray or bone scan (if bone pain)

Source: This information is according to the International Federation of Gynaecology and Obstetrics (FIGO).

In addition to the tests suggested by the International Federation of Gynaecology and Obstetrics (FIGO) in Table 6.2, the specialist(s) at the hospital may conduct additional tests to further investigate the extent of the cancer. These may include:

- blood tests, including full blood count and haemoglobin levels (to assess the presence of anaemia caused by blood loss, which, if present, can impact the effectiveness of radiotherapy), in addition to pregnancy and HIV tests when appropriate;
- kidney and liver function tests;
- computerized tomography (CT) scan or, better yet, magnetic resonance imaging (MRI) of the abdomen and pelvis (to help plan radiotherapy); however, treatment can be planned in the absence of these procedures if they are not available, affordable or feasible.

All investigations undertaken for the purpose of staging, and their results, must be carefully documented in the case record. A descriptive diagram can be included and provided to all health-care providers who will be involved in the patient's care.

a. FIGO staging system

A number of systems are used for cervical cancer staging. FIGO's staging system, based on tumour size and the extent of spread of the disease within the pelvis and to distant organs, is the most commonly used system (see Figure 6.1).

Figure 6.1: Revised FIGO staging system (2009)

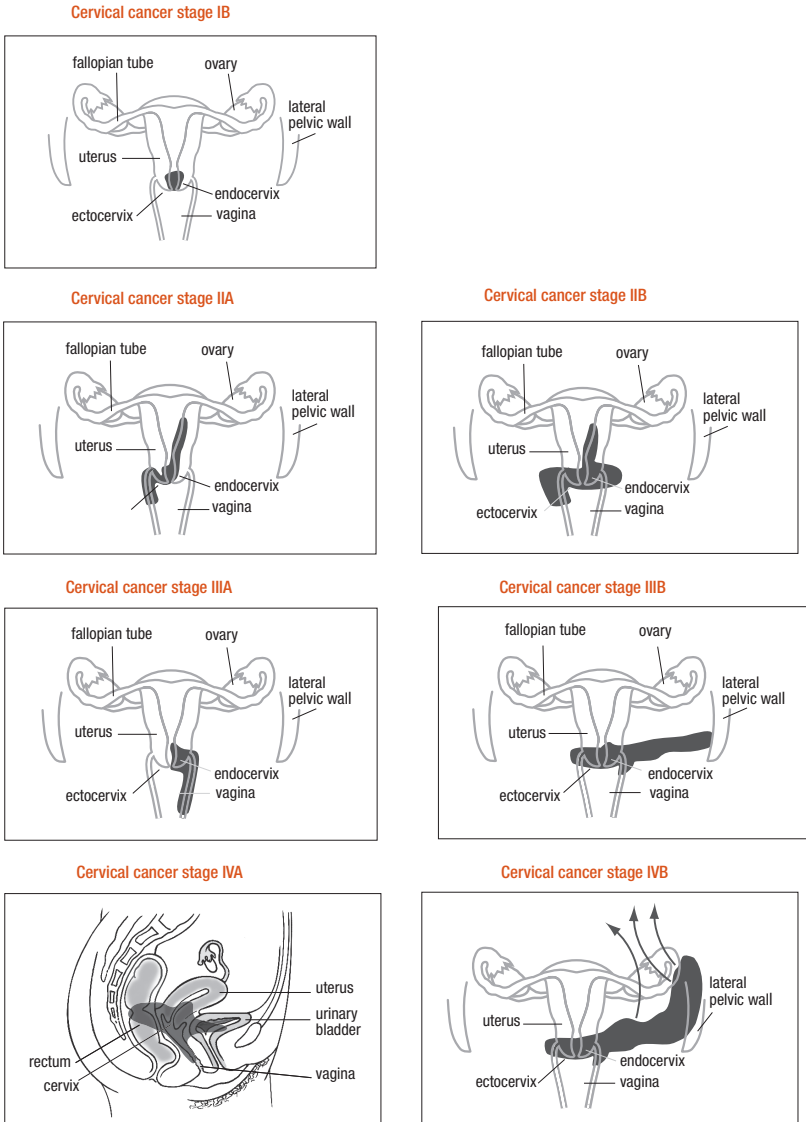

Sources: Edge et al. (2010), Gold et al. (2008), Pecorelli (2009); see Further reading

The FIGO staging system (2009 revision) describes four progressively more advanced stages of cervical cancer, from stage I to stage IV.

Summary of the FIGO stages and substages (as shown in Figure 6.1):

Stage I: The disease is confined to the cervix (includes substages IA1, IA2, IB1 and IB2).

Stage II: Cancer has spread outside the cervix into the upper vagina or to the tissue beside the cervix (parametrium), but not to the sidewall(s) of the pelvis (includes substages IIA1, IIA2 and IIB).

Stage III: Cancer has spread to the lower part of the vagina or all the way through the parametrium to the sidewall(s) of the pelvis (includes substages IIIA and IIIB).

Stage IV: Cancer has spread to surrounding organs or distant tissue, such as the lungs and distant lymph nodes (includes substages IVA and IVB).

b. Suggestions for tertiary care providers on how to talk with the patient about the importance of staging before it is conducted and after tests results are available

These conversations can be very emotional and may need more than one session. The utmost sensitivity and respect for the woman's clear understanding and reactions are essential. The patient should be offered the option of having with her one or more close family members or friends for support during this conversation. During this session, stop frequently and encourage the patient and her companions to ask questions. From time to time, assure yourself that she understands what you are saying and correct any misunderstandings, using different words.

In all conversations regarding cervical cancer, be mindful of cultural aspects of the patient's community.

See Box 6.1 on factors that influence prognosis and survival rates, and see Practice Sheet 6.4 for more specific suggestions for cancer specialists who need to speak with patients about their cancer and treatment.



Cancer specialists

Box 6.1: Factors influencing cervical cancer prognosis or five-year survival rates for women after completing the best treatment*

The single most important predictor of long-term survival is the clinical stage of the disease when first diagnosed.

The following additional factors also influence the chances a woman will survive for more than five years after treatment:

- access to treatment
- involvement of the lymph nodes (presence of cancer)
- presence of other chronic or acute diseases/conditions
- general health and nutritional status, including presence of anaemia
- degree of immunosuppression (e.g. HIV status).

*In countries where the best treatment is either not available or inadequate, survival rates are, obviously, significantly lower.

6.4 Treatment of invasive cervical cancer: overview

6.4.1 The principles of treatment

Each country or region has referral plans in place for women diagnosed with invasive cervical cancer to be seen and treated at tertiary-level institutions.

The therapeutic options offered to a patient should draw on international, national or institutional guidelines, based on the availability of qualified health-care professionals (i.e. surgeons, medical oncologists and/or radiotherapists/medical physicists) as well as the availability and condition of needed equipment. As described later, in section 6.6, there are some special treatment considerations for women who are pregnant or living with HIV.

In all cases, health-care providers should ensure that the chosen treatment, while reducing the extent of the cancer, will also probably reduce the patient's pain and suffering. If the treatment and/or its side-effects carry greater risks than the disease (i.e. more likely than the disease to shorten the patient's life, or likely to worsen the quality of her entire remaining life), then that treatment should not be considered.

Treatment should be individualized for the patient. The treatment plan is best decided by a team composed of gynaecologists, oncologists and radiotherapy specialists. Once this team is in place, they will consider the best interests and preferences of the patient and use this information to plan her treatment, selecting the best option or options based on the extent of her disease and her overall state of health. This treatment plan then needs to be discussed with the patient and conveyed to her

primary and secondary care providers using language appropriate for that patient (so that the providers can also reinforce the contents of the conversation using the same language) (see Practice Sheet 6.3).



What will happen at the hospital

Not all treatment options described in this chapter (section 6.5) are available at all tertiary-level facilities; the necessary equipment may not be in an acceptable condition, supplies may be lacking, or the providers' qualifications may not be up-to-date for provision of a particular treatment. Based on the availability and quality of services, the health-care provider charged with management of the patient will be able to explain the best option or options to her. If there is a choice between two treatment options with similar outcomes, or a choice between a single treatment and a combination of treatments, the patient and her support circle should be given details of each option as a basis for making an informed decision.

Once conversations and exchange of information about the extent of the disease and the treatment plan have taken place (see Practice Sheet 6.4), the provider will explain and review all the contents of the informed consent form used in the hospital and make certain that the patient understands what her signature means. Reassure her that she has the power to change what she has consented to if she wishes to do so for any reason. After this, the patient is asked if she is ready to sign and have witness signatures added (see Practice Sheet 5.1 on obtaining informed consent).



Cancer specialists



Informed consent

6.4.2 Choosing whether to treat and when to start treatment: the patient's own decision

The patient, once fully informed, is the person who has the power to choose whether to be treated, which treatment she prefers (if she is given a choice), and when to start. To do this, she will probably need to take into account:

- her personal and family situation
- her commitments at home
- the time needed for treatment
- expected treatment effectiveness and side-effects
- whether the treatment is included in her health insurance
- any out-of-pocket costs for her and her family if not covered by health insurance
- the consequences of no treatment.

In this process, the patient may also wish to consider the advice of people who are close to her.

6.4.3 Patient barriers to care

Treatment is often only available at tertiary care hospitals, which may be far from the woman's home, necessitating long periods away from home. The costs to the woman and her family and the disruption associated with treatment may be considerable and may even cause some women to refuse or stop treatment. If this is a possibility, providers at all levels of care can help by mobilizing support from the patient's family and community, and from the government and nongovernmental organizations. Some countries offer disability grants for women undergoing cancer treatment, while others offer accommodation close to regional cancer treatment centres; in other countries there is no support available. In some countries, that have no facilities for cancer treatment, women are referred to neighbouring countries for treatment and this may cause further hardship for her and her family. All of these issues need in-depth exploration in order to find solutions that will enable each woman to have the treatments that may cure her cancer or prolong and improve her life.

6.5 Treatment options

Cervical cancer treatment options include surgery, radiotherapy and chemotherapy, and these may be used in combination. Each option will be discussed in this section in sufficient detail to assist providers at all levels of the health system in keeping patients informed, always paying attention to use of appropriate nontechnical language. The terminology used here is intended to assist the provider in describing these therapies to a patient.

Depending on the stage of the cancer, the general health of the woman, and the availability of facilities and expertise, the primary therapy may be surgery or radiotherapy, with or without chemotherapy. Primary therapy (also called first-line therapy or primary treatment) is the first treatment for invasive cancer, usually with the objective of curing the disease. Adjunctive therapy is another treatment used with the primary treatment to assist the primary treatment. Secondary therapy refers to a treatment that can be given after another (primary) treatment has been used.

6.5.1 Surgery

Surgery consists of removal of varying amounts of tissue from the area involved with cancer and its surroundings. It can be done via the vagina or through an opening in the abdomen.

Surgery can be used as primary therapy as well as secondary therapy, after another treatment has been used.

The first two surgical procedures described here (cone biopsy and simple hysterectomy) remove less tissue while the third (radical hysterectomy) removes more tissue.

a. Surgery as primary therapy

Surgery as primary therapy for cervical cancer consists of the removal of a varying amount of tissue based on the extent of the cancer spread within the pelvis and other individual case characteristics.

Cone biopsy is the removal of a wide circle of tissue that surrounds the opening of the uterus and includes the lower portion of the cervical canal (see Figure 6.2). Microinvasive cancers (those that are entirely contained within the cervical epithelium) can be treated with cone biopsy, particularly if retaining fertility is an issue.

Figure 6.2: Cone biopsy – removal of a cone-shaped area of the cervix

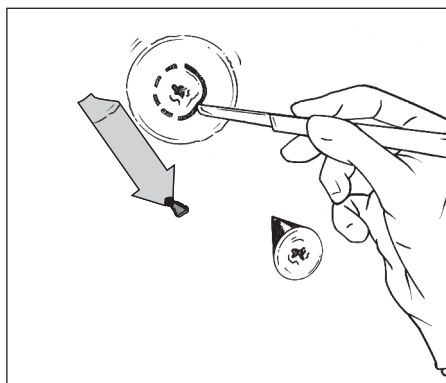

Simple hysterectomy is the surgical removal of the entire uterus, including the cervix, either through an incision in the lower abdomen or through the vagina with or without using laparoscopy (see Figure 6.3). The tubes and ovaries are not routinely removed, but they may be in postmenopausal women or if they appear abnormal. Simple hysterectomy is indicated for the treatment of early microinvasive cervical cancers in postmenopausal women and younger women who are not interested in preserving fertility.

Figure 6.3: Removal of the uterus by simple hysterectomy

Radical hysterectomy is the most common surgery for early invasive cancers. This surgery removes tissue to the side of the uterus and often lymph nodes in the pelvis and around the aorta (see Figure 6.4). The tubes and ovaries are not routinely removed unless they appear abnormal. See Annex 14 for information on how to process and record a radical hysterectomy specimen, including a sample pathology report form (Sample Form 14.1).

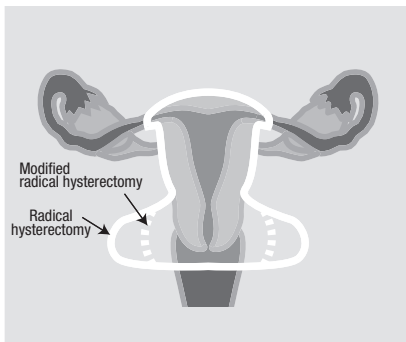

Pathology reporting
Cervical carcinoma

Figure 6.4: Radical and modified radical hysterectomy

b. Surgery as secondary therapy

Salvage surgery can still have the objective of curing the patient. It consists of radical hysterectomy including removal of a portion of the upper vagina to decrease chances of recurrence of the cancer. It is performed when:

- the patient has had primary surgery, but microscopic examination of the removed tissue shows that the margin of normal tissue around the cancer is too thin; or

- the patient has undergone radiotherapy and/or chemotherapy, but early recurrences or incomplete destruction of the cancer are noted on follow-up.

Palliative surgery is sometimes done in advanced cancer to relieve obstruction of the bowel, or to treat fistulae (abnormal channels between the vagina and the urinary organs or rectum) that result from radiation or extension of the primary disease.

c. Possible side-effects and complications of cervical cancer surgery

Possible side-effects and complications apply to all surgical interventions; the risks are generally small and mostly manageable. They include:

- a small risk of infection in the area of the surgery;
- bleeding;
- damage to the organs around the surgery (e.g. the bowel or bladder);
- a risk of clots in the deep veins of the legs if the patient is kept in bed and relatively immobile for days after surgery; this must be detected and treated early to prevent the clots from dislodging and travelling to the lungs.

In addition to the above general complications, surgery for cervical cancer has the following risks:

- Cone biopsy is associated with an increased risk of preterm labour and/or miscarriage when performed in pregnant patients.
- Hysterectomy results in infertility.
- Radical hysterectomy results in infertility and is also associated with bladder and/or bowel dysfunction.

For more information on hysterectomy as a treatment for cervical cancer, see Practice Sheet 6.5.



Hysterectomy

6.5.2 Radiotherapy

Radiotherapy (or radiation therapy) uses sophisticated equipment to produce invisible rays – similar to a ray of light but with higher energy – that are beamed onto the cancer and the surrounding affected areas. The rays penetrate the body and destroy cancer cells so that the cancer is fully or partially eliminated. Destroyed cancer cells are eliminated from the body.

Radiation itself is not painful but it may cause significant side-effects (refer to the end of this section).

a. Radiation as primary therapy

Primary radiotherapy, with or without chemotherapy, is used with curative intent, for women with cancer at stage IIA2 or greater (see Figure 6.1). It may be offered to women with cancers greater than 4 cm in diameter confined to the cervix, and for cancers that have spread beyond the cervix. Primary radiotherapy, intended to cure earlier cancers, is provided with daily treatments for 5–6 weeks using two modes of delivery:

- External-beam radiotherapy, or teletherapy, uses radiation originating from a machine located outside the body (see Practice Sheet 6.6).
- Internal radiotherapy, also called brachytherapy, uses radiation originating from radioactive material placed inside the vagina, close to the cancer (see Practice Sheet 6.7).



Pelvic teletherapy



Brachytherapy

b. Radiation as adjunctive therapy

Radiotherapy, with or without chemotherapy, may be given as adjunctive therapy in combination with primary surgery for the following indications:

- if, during primary surgery, the surgeon discovers that the cancer has spread beyond the cervix to the parametria (tissues between the uterus and the pelvic wall) or to other pelvic organs;
- after hysterectomy, if the pathology report indicates less than 5 mm of disease-free tissue around the cancer;
- if, during primary surgery, involvement of lymph nodes with cancer was found.

c. Radiation as secondary therapy

Radiotherapy, with or without chemotherapy, may be given as secondary therapy for the following indications:

- for recurrent disease located only in the pelvis in women who underwent primary surgery.

d. Radiation as palliative therapy

Palliative radiotherapy, usually without chemotherapy, may be used in a variety of settings (see also Chapter 7):

- as the only therapy in women with very advanced cancer;
- to control severe symptoms, such as bleeding, offensive discharge and/or pain;
- to assist a patient who is too ill to tolerate full-dose chemotherapy or radiotherapy (e.g. severe renal failure secondary to ureteric obstruction, liver failure, etc.);
- for treatment of isolated metastases (e.g. to vertebrae or lymph nodes without evidence of widespread metastases).

e. Side-effects of radiation for cervical cancer

Radiotherapy also affects multiple systems but only those directly exposed to radiation; in the case of cervical cancer this is usually the lower abdomen, including the urinary bladder, rectum and regional bone marrow. Other possible side-effects include menopause, infertility, discomfort or pain with intercourse, and possible bowel or bladder changes. Fistula is a rare side-effect.

6.5.3 Chemotherapy

Chemotherapy is the administration of repeated treatments with toxic drugs. A series of several treatments with one or more chemicals is given intravenously to kill rapidly dividing cells (a hallmark of all cancers).

a. Chemotherapy as primary therapy

Chemotherapy is rarely used alone as the primary treatment for cervical cancer; rather, it is used in combination with radiotherapy and less often with surgery.

b. Chemotherapy as primary therapy combined with radiotherapy

Chemotherapy is used first in women with very large and bulky tumours, to reduce the cancer size, and then followed by radiotherapy. Treatment is done in this sequence because cancer is shown to respond better to radiation when the tumour is less bulky.

c. Chemotherapy as palliative care

Palliative chemotherapy is sometimes used, after careful consideration of the expected benefits versus the adverse side-effects, to relieve symptoms in women with widespread metastases to liver, lung and bone.

d. Side-effects of combination therapy (chemotherapy and radiotherapy)

The side effects of combination therapy may be additive: those caused by the chemotherapy and the radiation. Because the toxic chemotherapy drugs circulate with the blood around the entire body, side-effects of chemotherapy will be widespread in the body. On the other hand, those caused by radiation will be limited to the pelvic area (see section 6.5.2 on radiotherapy).

Chemotherapy treatments affect not only cancer cells but also rapidly dividing cells in systems of the entire body: bone marrow, digestive system, urinary system, skin and other organs lined by epithelia. This means that there is a risk of anaemia, low white blood cell counts and infections, or bleeding from low platelet counts. Chemotherapy can also cause nausea and diarrhoea or allergic reactions to the drug. These are usually very short-lived and do not imply increased risks.

6.6 Special situations: cervical cancer in pregnancy and in women living with HIV

6.6.1 Managing cervical cancer in pregnant women

Although rare, cancer of the cervix is sometimes diagnosed in pregnant women. Cervical cancer does not cross the placenta, so the fetus is only affected by the direct spread of a very large cervical tumour or by complications from the methods used for the evaluation and treatment of the cancer.

Counselling a pregnant woman with cervical cancer requires particular skill and sensitivity. The issues are a great deal more complex and include helping her decide if she wishes to attempt to preserve her pregnancy. It is helpful to involve a multidisciplinary team of health-care providers and the woman's support circle in order to create a management plan that meets all needs and takes into account the complexities of decision-making in this context. It is often a heartbreaking set of choices for a couple and support may be required for both partners before, during and after treatment.

a. If the patient wishes to maintain the pregnancy

If the patient and her partner (if she wishes him to be involved in this decision) express hope to maintain the pregnancy, then most treatments will occur after delivery. Patients should be informed in advance that to avoid delivery complications caused by cervical dilation (such as haemorrhage), her delivery will be by planned caesarean before her labour initiates.

However, it is still important to perform a confirmatory biopsy of the lesion without delay. Performing a biopsy of the cervix in pregnancy is not contraindicated, but heavier bleeding than usual should be anticipated. For this reason it is advised that the biopsy be performed at the tertiary-level facility. Patients should be counselled that although biopsies are generally safe in pregnancy, as with any procedure during pregnancy, a biopsy has a small risk of being associated with a miscarriage.

b. If the patient does not wish to maintain the pregnancy

In this case, treatment is determined based on the stage of the cancer, in exactly the same manner described for nonpregnant women. If the patient's condition is suitable for simple or radical hysterectomy and disease is confined to the cervix, surgical options may be considered depending on the gestational age. Primary radiotherapy (with or without chemotherapy) may be another option; in this case, the patient needs to be informed that treatment will cause loss of the fetus.

6.6.2 Managing cervical cancer in women living with HIV

Because there are no well-designed or longitudinal studies on the treatment of cervical cancer in women living with HIV, there are no evidence-based guidelines on this subject to include in this guide. In their absence, this section presents some practices that are commonly used in the international and national arenas.

It is best for women living with HIV who have cervical cancer to be fully diagnosed, staged and treated at a tertiary-level institution with the appropriate expertise. Most institutions treating women living with HIV use multidisciplinary teams; each woman will be evaluated individually and an assessment made of her overall health and the existence of other chronic illnesses that may further compromise her immune system and her ability to tolerate immunosuppressive anti-cancer therapy (e.g. tuberculosis).

Both radiotherapy and chemotherapy are immunosuppressive therapies and surgery requires women to be relatively healthy in order to avoid complications such as postoperative sepsis, bleeding or wound problems. Therefore, a baseline CD4 count is a key element of care for women living with HIV and should be one of the initial evaluative tests obtained, regardless of the extent of the cancer. CD4 counts will also be needed to monitor the patient's immune status throughout treatment. If the CD4 count is or becomes low during therapy, she may be started on antiretroviral therapy, which may delay treatment to allow for recovery of her immune system.

6.7 Patient support and follow-up

6.7.1 Patient support during treatment

At all stages of disease diagnosis and treatment, it is important to assess and adequately treat pain and other symptoms. Additionally, women undergoing radiotherapy and/or chemotherapy will require regular blood counts and renal and liver function tests to identify and, if possible prevent, risks for infection.

Many cancer patients suffer from moderate to severe blood loss and chronic malnutrition, which may be improved by a healthy diet and provision of iron and folate supplements. Treating anaemia is also important because anaemia diminishes the effectiveness of radiotherapy.

Gentle vaginal douching and antibiotics such as metronidazole may reduce or eliminate the foul-smelling discharge often associated with treatment of advanced disease.

See Chapter 7 and its practice sheets on palliative care for more advice on managing common problems found in advanced cancer.

6.7.2 Patient follow-up

When a woman has completed treatment for cervical cancer, she is discharged from the hospital or outpatient unit. Before discharge, follow-up care is usually discussed at a meeting of all those who have been and will be involved in the patient's care; this discussion should include input from the woman herself and her family. Although follow-up would be best conducted at the tertiary-level cancer treatment centre, in reality most of these centres are tertiary-level hospitals located in major cities; if this is too far from the woman's home then the distance may prevent her from attending due to lack of time, transportation or money, or other personal constraints. Many women will thus chose to have follow-up at a facility closer to home. If this is the case, it would be beneficial for the gynaecologist from the secondary-level (regional) hospital to be present and participate in this important meeting about follow-up care.

When follow-up will take place at a distance from the treatment centre, a primary or secondary care physician with the skills to detect and manage problems or recurrence of cancer (often a gynaecologist) will have received a comprehensive report detailing the cancer stage, treatment administered and prognosis, as well as information about common problems that may occur and how to prevent or treat them. It is best to always include contact information (phone, fax, email, address) of the treatment centre in this report, to encourage those who are charged with the patient's follow-up care to provide regular feedback and seek advice from cancer experts if the patient presents with unexpected symptoms.

a. Follow-up for women treated with primary surgery and/or radiotherapy, with or without chemotherapy

It is advisable for women who have had any of these treatments to be seen and examined every three months post-treatment for a period of at least two years, which is the period during which most persistence or recurrence of disease will present or be detected. In addition, this is the period during which side-effects of treatment are most acute and need management.

During the follow-up consultations, the following activities need to be undertaken and fully documented in the patient's record:

- a thorough history to elicit and discuss all physical symptoms experienced by the patient;
- an assessment of her social, psychological/emotional and economic situation, and the impact of her illness and treatment on all of these factors;

- a full examination, including general systems and abdominal examination plus palpation of lymph nodes, with particular attention to the neck and groin;
- a speculum examination and visualization of the vaginal vault;
- an annual cytological smear of the vaginal vault for women who have only been treated with surgery (the role of VIA or HPV testing in this setting is unknown and has not been examined in clinical trials) – if the patient was treated with radiotherapy (with or without chemotherapy), then cytology will not add value to the post-treatment examination;²
- bimanual vaginal and rectal examination to palpate for recurrence of disease in the pelvis;
- other investigations will be determined by the patient's symptoms and the clinical findings, as well as the availability of resources.

Persistent or recurrent disease in women who have been treated with surgery alone may be treated (and potentially cured) using secondary treatment with radiation, with or without chemotherapy. However, if a woman had received primary radiotherapy, repeating it needs to be carefully planned to ensure that the area previously treated will not be exposed to more than the maximum allowable dose, which would cause serious damage and future complications.

6.7.3 Making a choice to stop treatment

For women undergoing chemotherapy and/or radiotherapy, it is very important to constantly monitor their response to the treatment. When it becomes clear that there is progression of disease or no relief of pain and other symptoms, then treatment focused on the disease is stopped. Maximal attention to providing control of pain and other symptoms remains the major focus of palliative treatment once the patient returns home. See Practice Sheet 7.1 on the evaluation of pain and Practice Sheet 7.2 on the management of symptoms.



Pain



Management of symptoms

Ensuring pain control and management is a prime goal both in and out of the hospital, when disease is curable and when it is not. It is discussed in great detail in Chapter 7.

When treatment is stopped, this is the time for the specialist provider(s) to contact local health-care providers and other caregivers who will be charged with the patient's palliative care. A report needs to be sent and should include contact information (phone, fax, email, address) of the treatment centre. Advice will be provided about how to provide the follow-up care for the patient and the treatment centre will request regular feedback on the patient's status. The local caregivers

² Novetsky et al. (2013), Rimel et al. (2011), Zanagnolo et al. (2009); see Further reading

may need additional training and, once trained, should be allowed to provide palliative support, pain control and care for patients in the local setting as the cancer progresses. Finally, the tertiary care providers should encourage the local caregivers to contact them to discuss any concerns, including for advice if the patient presents with any unexpected symptoms or if symptoms do not improve with specific treatment.

Further reading

- Barakat RR, Berchuck A, Markman M, Randall ME. Principles and practice of gynecologic oncology, 6th edition. Philadelphia (PA): Wolters Kluwer/Lippincott Williams & Wilkins; 2013.
- Edge S, Byrd DR, Compton CC, Fritz AG, Greene FL, Trotti A., editors. AJCC Cancer Staging Manual, 7th edition. New York (NY): Springer; 2010:395–402.
- Gold MA, Tian C, Whitney CW, Rose PG, Lanciano R. Surgical versus radiographic determination of para-aortic lymph node metastases before chemoradiation for locally advanced cervical carcinoma: a Gynecologic Oncology Group Study. *Cancer*. 2008;112(9):1954–63. doi:10.1002/cncr.23400.
- Novetsky AP, Kuroki LM, Massad LS, Hagemann AR, Thaker PH, Powell MA, et al. The utility and management of vaginal cytology after treatment for endometrial cancer. *Obstet Gynecol*. 2013;121:129–35. doi:http://10.1097/AOG.0b013e31827499a9.
- Pecorelli S. Revised FIGO staging for carcinoma of the vulva, cervix, and endometrium. *Int J Gynaecol Obstet*. 2009;105(2):103–4.
- Rimel BJ, Ferda A, Erwin J, Dewdney SB, Seamon L, Gao F, et al. Cervicovaginal cytology in the detection of recurrence after cervical cancer treatment. *Obstet Gynecol*. 2011;118(3):548–53.
- Wiebe E, Denny L, Thomas G. Cancer of the cervix uteri. *Int J Gynaecol Obstet*. 2012;119(Suppl 2):S100–9. doi:10.1016/S0020-7292(12)60023-X.
- Zanagnolo V, Ming L, Gadducci A, Maggino T, Sartori E, Zola P, et al. Surveillance procedures for patients with cervical carcinoma: a review of the literature. *Int J Gynecol Cancer*. 2009;19:194–201.

7

CHAPTER 7: PALLIATIVE CARE

Chapter 7. Palliative care

Key points

- Palliative care is an essential element of cervical cancer control.
- Palliative care improves the quality of life of patients and their families facing the problems associated with life-threatening illness.
- Palliative care consists of the prevention and relief of suffering by means of early identification and assessment and treatment of pain and other forms of physical, psychosocial and spiritual suffering.
- Palliative care can help people with advanced disease to have dignity and peace during difficult and final phases of life.
- Palliative care is best provided using a multidisciplinary team approach involving the patient, her family and close support persons, community health workers and special palliative care workers in the community, as well as health-care providers at all levels of facilities.
- The mechanisms for palliative care implementation, including education and the availability of medicines, need to be strengthened.
- By using a broad combination of medical and non-medical methods, most pain can be effectively controlled.
- Nurses with appropriate training may be allowed to prescribe strong oral opioids, subject to the national norms and guidelines.
- Quality of palliative care very much depends on adequate training and supervision for health care providers and, if possible, for community-based caregivers.
- Access to all necessary medicines, equipment and supplies is critical for symptom management, both at the health-care facility and in the patient's home.

About this chapter

This chapter deals with essential and often neglected components of a comprehensive cervical cancer control programme and builds on the following WHO publications about palliative care and pain treatment:

Cancer pain relief: with a guide to opioid availability, 2nd edition. Geneva: WHO; 1996 (<http://whqlibdoc.who.int/publications/9241544821.pdf>).

WHO guidelines for the pharmacological treatment of persisting pain in children with medical illness. Geneva: WHO; 2012 (http://whqlibdoc.who.int/publications/2012/9789241548120_Guidelines.pdf).

Ensuring balance in national policies on controlled substances: guidance for availability and accessibility of controlled medicines. Geneva: WHO; 2011 (http://www.who.int/medicines/areas/quality_safety/guide_nocp_sanend/en/, accessed 18 July 2014).

World Health Organization (WHO), U.S. President's Emergency Plan for AIDS Relief (PEPFAR), the Joint United Nations Programme on HIV/AIDS (UNAIDS). Task shifting: rational redistribution of tasks among health workforce teams: global recommendations and guidelines. Geneva: WHO; 2008 (<http://www.who.int/healthsystems/TTR-TaskShifting.pdf>, accessed 23 October 2014).

While no new recommendations are included in this chapter, please note that new recommendations on pain and palliative care are forthcoming following passage of a resolution on palliative care at the 2014 World Health Assembly.¹

The chapter is presented in five main sections. Section 7.1 provides an overview of palliative care and emphasizes the importance of having a multidisciplinary team of trained, home-based, community-based and facility-based palliative care providers, who can make the progression of a patient's advanced cervical cancer more comfortable. Section 7.2 reviews the role of the family, who are considered part of the care team. Section 7.3 details the roles of health-care providers at all levels of the health system. Section 7.4 provides advice on the management of symptoms, especially pain. The final section, section 7.5, focuses on the important issue of keeping the patient and her support circle informed at each stage.

Most of the issues addressed in this chapter are also relevant to patients who need palliative care for other incurable diseases.

The practice sheets for this chapter provide detailed instructions on the evaluation of pain, home-based management of pain and other distressing symptoms and problems encountered in patients with cervical cancer, and advice on talking to patients who are returning home under palliative care.

¹ WHO (2014), see Further reading

Amelia's story

Amelia is a 57-year-old Angolan woman, with six children and many grandchildren. She was taken to the nearest district hospital, 95 km away from her home, by her eldest daughter, after she developed a vaginal discharge with a very bad odour, which persisted for many months. The doctor who examined her did some tests, and explained that she had advanced cervical cancer that had spread from her cervix to her vagina and bladder and the walls of her pelvis. The bad odour was caused by urine leaking from her bladder into her vagina and mixing with discharge from the tumour. The doctor said that unfortunately, at this stage, there was no treatment or cure for her cancer, but that she could be cared for and made comfortable at home. She also gave Amelia and her daughter instructions for managing and reducing the vaginal discharge and odour. She added that she worked with community health workers near Amelia's village, who provide home-based care for people who are very sick with AIDS, cancer or other illnesses. Then the doctor wrote a referral note to the woman in charge of the home-based care organization, explaining Amelia's condition and asking her to visit her at home. The doctor said she would work from a distance with the local health workers closer to Amelia's village to make sure that Amelia would have the medicines she needed, including medicine for pain, which might get worse as the cancer progressed.

Although Amelia and her daughter were shocked and saddened by the news, the doctor's kindness and concern reassured them. Her promise to watch over her care with the local health workers made them both feel more confident and hopeful.

The local health worker came to visit Amelia as promised. She told and showed Amelia and her daughter how to deal with some of the problems they were facing: how to prepare pads from old, clean clothes to absorb the vaginal discharge; how often to change them and how to wash them; how to apply petroleum jelly to the vaginal area as the skin was beginning to get irritated from the constant moisture; how to gently wash the area daily with soap and water, and have sitting baths. With Amelia's permission, she spoke to the family about supporting Amelia and each other during her illness, and emphasized the importance of sharing the work as Amelia's condition got worse. There would be more laundry, as bedding and underwear would need to be washed often; the bed should be protected from discharge and urine with a plastic sheet; medicines for pain could be bought at low cost from the local mission hospital, and someone would need to fetch them regularly; other help at home was available through Amelia's church. Amelia's family was poor, but the health worker helped to organize support from the community, the church and the local mission so that the needed supplies were usually there.

Continued on next page

Amelia's story *(Continued)*

The local health worker helped Amelia's family to understand the importance of keeping Amelia involved in their daily lives, and the life of the community. The family arranged for friends to visit when Amelia felt well enough, they took turns preparing food and, when she became too weak to leave her bed, they made sure that someone was always there for her. Amelia felt that she was not cast aside because of her illness. Even as she approached death, conversation and good spirit kept the house full of life and Amelia felt loved and needed until the end of her life.

7.1 A comprehensive approach to palliative care

Palliative care for patients with long-lasting incurable diseases, including advanced cervical cancer, offers medical, emotional, social and spiritual support. The palliative care team includes health professionals such as physicians and nurses, community health workers, and many family caregivers. Caregivers at all levels and in all settings are part of a holistic approach to serious illness and approaching death. In addition to managing pain and other cancer symptoms, palliative care includes providing support at the community level to mobilize local resources and establish links to treatment centres.²

7.1.1 What is palliative care and why is it necessary?

Palliative care aims to improve the quality of life of patients and their families facing problems associated with life-threatening illnesses and conditions. Palliative care is not only end-of-life care, but also includes interventions applied throughout the disease trajectory (see Figure 7.1) to manage all distressing symptoms, including pain, as well as helping to address the emotional and spiritual needs of patients and their families. The patient's future needs should be considered at the time she is diagnosed with advanced cancer, so that problems can be anticipated, and prevented or managed. Palliative care can be provided by people in the community, by local health centres and by hospitals, and is provided both in the home and at health-care facilities or community-based institutions. Palliative care is a basic human right, recognized under international human rights law.³

Palliative care is characterized by the following features:

- It provides relief from pain and other distressing symptoms.
- It affirms life and regards dying as a normal process.

² WHO (2004), see Further reading

³ OSF (2011), see Further reading

- It is intended neither to hasten nor to postpone death.
- It integrates the physical, psychological and spiritual aspects of care.
- It gives the patient and her family as much control and decision-making power as they desire and are able to accept.
- It offers a support system to help patients live as actively as possible until death.
- It offers a support system to help the family cope during the patient's illness and in their bereavement.
- It uses a team approach.
- It will enhance quality of life, and may also positively influence the course of the illness.
- It is applicable early in the course of illness, in conjunction with other therapies that are intended to prolong life, such as surgery and radiotherapy.

Figure 7.1: The role of palliative care throughout the disease trajectory: the continuum of care

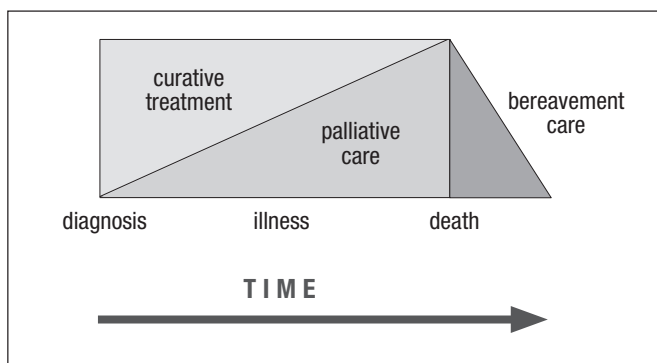

As indicated in Figure 7.1, at the time of diagnosis of advanced cancer, treatment takes priority and the role of palliative care, although present, is secondary. As the illness advances further, palliative care gradually takes precedence. Bereavement care with the extended family is part of the continuum of care after the patient dies.

Palliative care is necessary even though cervical cancer is a preventable and curable disease. Ideally, the appropriate resources, training and education should be available and implemented for the prevention of premature and unnecessary deaths from cervical cancer. Unfortunately, many women are still being diagnosed with cervical cancer when symptoms develop, which is usually in the advanced stages of the disease (see Chapter 6). In addition, in low-resource settings, facilities for the treatment of cervical cancer may not exist or may not be accessible to many women; as a result, some women with relatively early cancers will not receive effective

treatment, resulting in progression of the disease. In these settings and situations, palliative care should be made available as the most effective treatment.

Patients with other chronic life-threatening conditions also need palliative care as an integral part of the health-care continuum, and efforts should be made to create a team of health-care providers at all levels of the health system with the necessary knowledge and skills. Patients' families should be included in palliative care as they will need to both give and receive care.⁴

The World Health Assembly (WHA) 2014 resolution on palliative care is a commitment by governments worldwide to further develop national norms and services in order to increase access to palliative care for all patients in need.⁵

7.1.2 Essential components of palliative care

Essential components of palliative care include prevention and management of symptoms, pain relief, and psychosocial and spiritual support. Effective pain control can be achieved in most cases using medical management, together with ancillary non-medical methods. Psychosocial and spiritual support are important components of palliative care and require trained providers with good communication skills. In addition, at the community level, palliative care needs to include all elements that will keep patients well nourished, clean, and as active as they wish to be. The patient's family members also need to be trained in their roles, including how to obtain and use needed supplies to care for her.

At tertiary-level facilities, prevention and management of symptoms may include palliative radiotherapy to reduce the size of the tumour, as well as treatment for vaginal discharge, fistulae, vaginal bleeding, nutritional problems, bedsores, fever and contractures.

If possible, family members and community workers should be trained in palliative care while the patient is still in the hospital. This training and advice should cover prevention and management of problems, and how to offer the patient support in her daily activities, such as bathing, going to the toilet and moving around. If the patient's symptoms cannot be managed, the family needs to ask local providers to make home visits to provide support and advice and, if necessary, arrange for admittance to the appropriate level facility.

⁴ Connor et al. (2002), see Further reading

⁵ WHO (2014), see Further reading

7.1.3 A team approach to palliative care

Providers at all levels of care, from specialists to home-based care providers, work together to ensure the best quality of life and outcome for patients with advanced cervical cancer. At tertiary care settings, the team might include a gynaecologist, a radiotherapist, a radiotherapy technician, a psychologist or counsellor, a nutritionist, a physiotherapist, an oncology nurse, a pharmacist, a social worker and a palliative care nurse. In resource-poor settings it is unlikely that such a highly specialized team can function down to the level of the community where the woman lives. In such settings, community health workers – supported, trained and supervised by primary- and secondary-level health-care professionals – are the principal providers of palliative care.

There should be a smooth transfer of medical information among the various health-care professionals responsible for patient care. Where appropriate, this involves efficient exchange and sharing of medical records between community-level and tertiary care teams.

All patients and family caregivers should be informed whom they can contact at which facility, if needed, and how they can reach him or her. Strategies need to be devised to allow community health workers to link the patient and her family with staff at the primary-, secondary- and tertiary-level facilities.

Communication is best if a system is formally established and willingly implemented by all team members, including tertiary care specialists, before the patient is discharged from the treatment facility. Health-care providers at all levels need to be trained to use the same words and nontechnical, culturally sensitive language when in the presence of patients and their family and community members, and to have the resources necessary to manage the most common physical and psychosocial problems, with special attention to pain control.

7.2 The role of the family in palliative care

7.2.1 Involving the family⁶

The family plays a unique and essential role in palliative care. The health-care provider should ensure that the patient and her family understand the nature and prognosis of the disease and the recommended treatment.

With the help of community health workers, the family will be empowered to participate in the decision-making, and will be kept informed of medical decisions,

⁶ In this context, “family” includes anyone the patient considers to be significant to her.

including changes in caregivers and treatment, and should be guided in best practices of palliative care. The patient's family and other caregivers can be taught to provide home-based care. Clinical care can be provided by health workers trained in the use of recommended medicines within the national legal framework. Providers of palliative or home-based care, with continual back-up from the primary care provider (i.e. physician, clinical officer or nurse), will be able to take care of most of the patient's needs.

7.2.2 Accessing local resources for care at home

When the patient is no longer able to work or care for her family, meagre resources may become further stretched. In this case, money for food, supplies and medicines for her care may be obtained by the family from local and regional nongovernmental and faith-based organizations. It is very useful for community health workers to have established links with these organizations before they are needed, so that patients can be referred to them as needed.

7.3 The roles of health-care providers

Providers at all levels of the health system need to work as a team, to provide treatment, comfort and care, and to convey accurate information and skills to the patient, her family and the community. To be able to do this, providers need specialized training in management and treatment of both physical and emotional problems, as well as in communication skills. Also there is an immense range of behaviours, feelings and beliefs regarding death that are affected by cultural context and that should be taken into consideration. See Chapter 3, sections 3.1 and 3.5 for information on communication and counselling skills, and section 7.5 later in this chapter, which discusses keeping the patient and her support circle informed. Also refer to Practice Sheet 3.4 on counselling, Practice Sheet 6.4 for tertiary-level providers on talking to patients about their cancer and treatment, and Practice Sheet 7.3 on having a conversation with a patient who is returning home under palliative care.



Counselling



Cancer specialists

Counselling:
Palliative care

A trained palliative care worker enables the patient and her support circle to make decisions about the patient's care. The patient and her family will feel that they are in control, with full support from the health-care team, whose task it is to provide appropriate information and advice and to support informed decisions.

7.3.1 The role of community health workers

Community health workers (CHWs) and other special members of the community who are dedicated to assisting with palliative care, in coordination with primary- and secondary-level providers, have a role in the following:

- Develop a personal care plan in order to provide the patient with home visits on a regular, scheduled basis, to anticipate and, if possible, prevent and manage any problems.
- Provide treatments, instruct the family in this task, and train the patient and her family on care and comfort-giving procedures, and check that these are being done.
- Facilitate access to supplies and medicines.
- Routinely conduct assessment of the patient's physical, psychosocial and spiritual needs, and inform the patient's primary care provider (physician) of the findings.
- Based on the assessments and feedback from the patient's primary care provider (physician), pay particular attention to ensuring as far as possible the availability of treatment, including for pain management.
- Answer questions, provide information and keep records.
- Encourage the family to keep the patient involved in their daily lives as much as possible.

7.3.2 The roles of physicians and authorized prescribers at primary- and secondary-level facilities

Physicians and authorized prescribers have the following roles:

- Visit the community on a regular basis to conduct training sessions for community health workers; this also provides an opportunity to learn about the conditions in which they work, and in which their patients live.
- When visiting the patient, counsel and educate her and her family on how to prevent common problems, such as contractures and bedsores and, if they occur, how to manage them.
- Support and supervise the community team and the patient and her family on matters of treatment and care.
- Attend training courses in palliative care organized at primary- or secondary-level facilities.
- Write prescriptions for analgesics, including oral morphine where available, and for medicines to treat pain and other symptoms.

- Prescribe, provide, supervise, support and maintain supplies (including medicines) for those community health workers who do home visits for women with cervical cancer, or directly for patients and their caregivers for immediate use or to be used if and when needed.
- Provide emergency or routine follow-up care for problems after diagnosis or treatment for invasive cancer.
- Refer patients where possible to higher-level facilities for inpatient care for acute problems that are best managed there, such as severe vaginal bleeding and intractable pain (the latter by the use of radiotherapy).
- Help arrange transportation for patients to these locations if possible.
- Maintain contact with community health workers and palliative care providers, and follow up on the care of patients referred by them.
- Provide distance supervision and assistance by being available for consultations as appropriate.

7.3.3 The role of providers at tertiary-level facilities

Providers at the tertiary-level hospital have a role in the following:

- Provide tertiary-level, inpatient care for patients with intractable pain and other symptoms, including radiotherapy and other treatments only available at this level.
- Provide emergency care on an outpatient basis for symptoms causing great distress (e.g. vaginal bleeding), if feasible.
- By using national pain and palliative care guidelines, keep the patient pain-free with adequate medications, including morphine.
- Report back to referring providers and be available for further distance consultations.

The delegation of some tasks to primary-level providers must only be implemented if there are adequate systems in place to legally protect both health-care providers and patients. Some countries have already changed their policies and regulations in order to allow nurses and clinical officers to prescribe opioid medicines in order to provide improved coverage for pain relief.

Additional documented evidence is needed to inform policy-makers about possible strategies for increasing coverage of services while maintaining quality of care. WHO has developed a series of global recommendations and guidelines on task shifting of HIV services;⁷ the general principles can be adopted for the delegation of other tasks in the health system and therefore may be useful when planning the provision of palliative care to cervical cancer patients.

⁷ WHO, PEPFAR, UNAIDS (2008), see Further reading

7.3.4 The role of health-care providers in anticipating death and dying

The topics of death, dying and bereavement must be understood and addressed within the context of local cultural and regional knowledge, beliefs, practices and behaviours. Use compassionate and culturally sensitive language when addressing death and dying with patients, families and their communities.

a. Anticipating practical issues

It may be difficult for many families to prepare for the likelihood that their ill relative will die while they are still hoping for remission or prolongation of life. Health-care providers should be very sensitive to the patient's and the family's ability to deal with the reality of the situation and should adjust their interventions depending on the readiness of the patient and her family to take practical steps to prepare for anticipated death.

Acknowledging the need for hope while planning for the worst do not have to be mutually exclusive. It is helpful to discuss important issues with the patient and with her family, if she consents to this. Topics to be discussed are:

- the goals of care (e.g. prolonging conscious life until distant family can come to say goodbye, reducing distress and pain);
- how to go about putting personal affairs in order, such as wills, funeral arrangements, family finances and completion of obligations, which may help patients and their families gain a sense of greater control in this difficult situation;
- what to do when death occurs, including avoidance of unnecessary resuscitation and prolonging of life if it is against the patient's wishes.

Discussing and assisting with these practical steps, according to the prevailing cultural context, may also allow for the completion of the family's emotional tasks.

b. Preparing for death

Encouraging communication within the family can make a death less stressful and ease bereavement (see Chapter 6, section 6.7.3, and also section 7.5.4 later in this chapter, for additional advice on how to talk with the patient and her family when the cancer is incurable). At times, the patient may express anger or other strong emotions towards her closest family members and health-care providers; such outbursts need to be accepted and not taken personally. Reactions to impending death are always affected by the cultural context; thus, sensitive assessment of her willingness to discuss these issues is needed before starting the conversation. Always remember that attentive listening and calming body language can be most important.

Together with the family, the trained health-care provider can contribute to supporting the dying woman by:

- providing comfort and care;
- helping her deal with guilt or regret;
- talking about her impending death (after checking that she wants to discuss this);
- responding to grief reactions, such as sadness, guilt, yearning, anger, despair and avoidance;
- keeping communications open, and giving her the chance to talk about her thoughts and feelings, without pressuring her if she is not ready to talk;
- offering practical support, asking who she wants to care for her, where she wishes to receive care, what limits she wishes to place on visitation, what special requests she has, and so forth;
- asking her if she wishes for pastoral care (by whom and when);
- if appropriate, asking her where and with whom she wishes to be at the time of death;
- assuring her that her wishes and confidentiality will be respected.

When considering the possibility of transferring the patient to the hospital, the patient's wishes are the primary consideration if she is conscious; if she is unconscious, her family's wishes can be considered. It is usually not appropriate to transfer a dying patient. If death is not expected in the immediate future, and the family needs some respite, consideration may be given to transferring her to the secondary-level hospital or to a hospice, if available and affordable.

c. Death

At the time of death, it is essential to respect local rites, rituals and customs, as well as any expressed personal wishes of the patient or family concerning care of the body, funeral arrangements and other issues. A visit to the home at the time of death is usually appreciated.

d. Bereavement

Bereavement care is support given to the family after a patient's death, to help them cope with the loss of their loved one. Home-based and clinic-based care providers involved in a woman's end-of-life care can share the family's sorrow, by encouraging them to talk and express their memories. Workers should not offer false comfort but should be supportive, take time to listen, and try to arrange practical support with neighbours and friends. Palliative care services usually include some ongoing follow-up care with bereaved families to support effective grieving and continuing community support, as well as to assess and assist families where prolonged grief may interfere with adjustment back to adaptive functioning.

7.4 Managing common symptoms in advanced cervical cancer

Women with advanced cervical cancer can suffer a constellation of physical, psychological and emotional problems. Pain is almost always part of the constellation, and its relief should always be part of palliative care.

7.4.1 Pain management

Pain is one of the most common symptoms in advanced cancer. The vast majority of women with cervical cancer will most likely suffer from moderate to severe pain. Moderate and severe pain should always be addressed, and opioid analgesics are often essential for pain treatment.

What is known about provision of pain relief for cancer patients?

- It is vastly underutilized, even in some high-resource settings and, as a result, many patients suffer needlessly.
- Most pain can be relieved satisfactorily.
- The patient is the best source of information on her pain; the pain needs continual assessment (see Practice Sheet 7.1).
- It is very useful to have collaboration and regular communication between patients and their home-based caregivers as well as with clinical providers at all levels of the health system; home-based caregivers are most in touch with the patient's needs, while clinical providers can offer support and medicines.
- There are potential adverse effects of medicines used for pain management.⁸



Pain

The availability of strong pain medicines, including opioids, varies considerably from country to country. Oral morphine is not readily available in many countries, but WHO policy guidelines recommend that all countries adopt policies that allow patients to have access to controlled medicines (medicines that are controlled as drugs, to prevent misuse) when they need them.⁹ Side-effects of the use of morphine, such as constipation, will need to be followed up and treated. Providers will need to use available pharmaceuticals to the extent they can to relieve pain, while continuing to advocate for improved access to all WHO listed medicines for pain and palliative care.¹⁰

7.4.2 Barriers to effective pain relief

The following are the major categories of barriers to effective pain relief:

- **Legislative and policy barriers:** The existence of excessively restrictive laws and policies may prevent ready access to controlled medicines for patients and their caregivers in the community.

⁸ Please refer to the WHO model lists of essential medicines; WHO (2013), see Further reading

⁹ WHO (2011), see Further reading

¹⁰ WHO (2013), see Further reading

- **Out of date national norms and guidelines:** These norms and guidelines may not be regularly updated in accordance with international drug control conventions and guidelines.
- **Inadequately trained health-care providers:** The education of health-care professionals may be deficient due to very limited attention to palliative care in the curricula of medical, nursing and pharmaceutical schools. Graduates of training institutions may not have learnt to feel confident with the use of sufficient opioids to control pain and may lack knowledge on common side-effects and their management.
- **Negative health worker beliefs that are not evidence-based:** There may be persisting beliefs among health workers that cause them to use opioids incorrectly. For example, they may believe that long-term use of opioids will hasten a patient's death and/or cause dependency.
- **Economic barriers:** Low profit margins, high prices and low turnover may lead to a lack of availability of opioid analgesic preparations in a country.

Where opioid analgesics are available, national rules and regulations must be followed. However, they should be carefully checked to see whether they allow pain relief to be administered adequately. If not, medical and non-medical people need to join forces to advocate for patients' palliative care to include freedom from pain.

In 2011, WHO published the policy guidelines *Ensuring balance in national policies on controlled substances: guidance for availability and accessibility of controlled medicines*.¹¹ These guidelines can be used to identify barriers to accessing opioids and other strong medicines and they can also be used as a reference when developing adequate legislation and policies, including for pharmacies, that balance access to opioid analgesics and other controlled medicines for medical use against the risks of diversion and opioid dependence in society.

7.4.3 WHO's analgesic ladder

WHO's three-step ladder of cancer pain relief, which was published in 1986,¹² provides guidance on how to manage cancer pain. Today, in many countries, the approach is, however, to skip the second step and to use low dosages of strong opioids like morphine instead, in order to manage pain in a timely and effective manner. New guidelines on adult cancer pain management will be developed by WHO in the near future and should be consulted once published.

7.4.4 Non-steroidal anti-inflammatory drugs (NSAIDs)

NSAIDs are a class of medicines that reduce pain and inflammation. NSAIDs are often used to relieve mild to moderate pain for all types of cancer, as well as the pain of

¹¹ WHO (2011), see Further reading

¹² WHO (1986), see Further reading

arthritis, menstrual cramps, sore muscles following exercise, and tension headaches. Most NSAIDs are available in over-the-counter formulations. Some of the NSAIDs used in cancer treatment include: ibuprofen, naproxen, nabumetone, ketorolac, sulindac and diclofenac. NSAIDs may be given in addition to opioids in safe doses; for example, to treat bone pain more effectively.

7.4.5 Opioids

From a pharmacological viewpoint, opioids include all chemical substances that work similarly to morphine to relieve pain. Opioids can originate from the poppy plant or they can be synthesized and they can even be made by the body itself (endorphins); they may or may not be chemically related to morphine. The analgesic (pain relieving) effects of opioids are due to a decreased perception of pain and decreased reaction to pain, as well as increased pain tolerance. The more common side-effects of opioids include constipation, nausea, sedation, respiratory depression, euphoria and drowsiness. Opioids can also cause cough suppression, so coughing is another indication for administering an opioid. Systematic review of the evidence suggests that fentanyl, morphine, hydrocodone, oxycodone and methadone are equally effective.¹³ However, patients have a greater preference for transdermal fentanyl. Studies suggest less constipation and urinary retention among patients using fentanyl, while less nausea, sweating and diarrhoea were reported with oral morphine. The local price of medicines is an important consideration when selecting the preparation to be used.¹⁴

Occurrence of opioid dependence in pain patients treated with them is rare and should not be a reason for not treating moderate and severe pain with the most effective doses determined for each patient.¹⁵

A stepwise approach to analgesic treatment should be used, beginning with paracetamol and NSAIDs for mild pain, and strong opioid analgesics for the relief of moderate to severe pain in women with cervical cancer.¹⁶

Analgesics are more effective when administered “by the clock” – at regular fixed intervals – rather than “as needed”. The oral route is preferred for the administration of all medications for pain, including morphine.¹⁷

Oral morphine is effective as the first-line treatment of persisting moderate to severe pain in women with cervical cancer.¹⁸

¹³ WHO (2004), see Further reading

¹⁴ Tassinari et al. (2011), Wiffen & McQuay (2007), see Further reading

¹⁵ Minozzi et al. (2013), see Further reading

¹⁶ WHO (2014), see Further reading

¹⁷ WHO (2004 and 2014), see Further reading

¹⁸ WHO (2014), see Further reading

7.4.6 Non-pharmacologic methods to assist in pain control

Many non-pharmacologic methods appropriate to local customs and culture can help control pain. These methods can be used together with pain medicines but should never take the place of effective pain-relieving medicines. Non-medical pain management may include: emotional support, physical methods (touching and massage), distraction, music, art and other expressive therapies, guided imagery and relaxation therapy, aromatherapy, animal therapy, prayer, meditation and non-harmful local traditional methods. Acupuncture and other Asian or traditional Chinese therapies may also be utilized. Massage therapy has been shown to be an effective adjunctive method for pain control. These pain control methods should be provided by qualified professionals and only with the explicit understanding and approval of the patient and her family. The patient should be encouraged to inform her health-care providers about additional methods she wishes to utilize.

7.4.7 Other problems of advanced disease

In addition to pain, other symptoms and problems that are common in advanced cervical cancer include: vaginal discharge, fistulae, vaginal bleeding, nausea and vomiting, diarrhoea or constipation, fever, loss of appetite, wasting, weakness and fatigue, leg swelling, bedsores, shortness of breath, bowel or bladder incontinence, anxiety and depression. See Practice Sheet 7.2 for information on managing vaginal discharge, fistulae and bleeding at home; this information is aimed at primary-level, community-based and home-based caregivers, and includes relevant information on infection prevention and counselling.



Management of symptoms

7.5 Keeping the patient and her support circle informed

7.5.1 For the tertiary-level provider: informing the patient of the cessation of curative treatment

Patients should be informed about therapeutic options at all stages of the disease and play an active role in decision-making. When it becomes clear that no further curative treatment will be of benefit to the patient because it is not having any positive effect on her health and cancer status, it is best to counsel the patient and family in a sensitive but truthful manner. It is also important to let patients know that even though cancer treatment may not help, you are still committed to her comfort and to treating symptoms that she has, including pain. Try to avoid saying “nothing more can be done”, because caregivers can do many things to help by relieving symptoms, supplying medicines, arranging lower-level care, or just being available. For a patient who has been in hospital and is going home, this is the time to contact local health-care providers who can provide palliative care. Questions about how much time is left should be answered honestly, i.e. that you do not know but it may

be a question of a few days, weeks or months as appropriate for her situation. This will give an indication to the patient and family of what to expect, so that they can make appropriate arrangements.

It is best to be as calm and supportive as possible: this is a very emotional and saddening conversation that must take place. It is not acceptable to have a low-level staff person come and inform the patient that his physicians have decided to discharge her from the hospital.

First enquire about how she is feeling, what symptoms are present and who is in her home and community that she knows can help with her physical, emotional and spiritual needs. When this topic is discussed in detail, you will review with her what has been done in the past few weeks to care for her health and then very carefully approach the topic that no improvement has been achieved in the last X number of weeks or months. Let the patient know that the team of doctors taking care of her at the hospital have all agreed that it would be best for her to return home and be with her family and support circle, who are the best people to provide her with comfort and peace. Inform the patient about the possibility of making advance directives (also known as a “living will”), since this may be helpful later if or when she is not in a condition to take decisions for herself. Also inform her of the assistance that you and the hospital are able to provide for her.

Finally, inform the patient that a complete report will be sent to the primary care providers and community health workers including suggested treatments for her continuing symptoms and for any new symptoms that may be expected, urging these providers to accompany the patient during this stage of her life. The report should include contact information (phone, fax, email, address) of the treatment centre and should request regular feedback on the patient’s status and encourage them to seek advice if the patient presents with unexpected symptoms. Be sure that the patient’s local providers know that you and your team are available to talk with them about any concerns they are having about the near future course of the patient.

7.5.2 For the primary- and secondary-level providers and home-based caregivers: having a conversation with the patient when she returns home

When the patient is released from hospital and returns home, providers in her community and at primary and secondary levels of care should visit her and, if she so wishes, her family, to establish a warm and trusting relationship. After greetings and necessary introductions, you can start by talking about what she loves about being home again and having her close circle around her. Most importantly, assure her that you will be available when needed and inform her of how she can reach you at any time, but also tell her that a lot can be done by caregivers to relieve symptoms, including

providing a supply of medicines and arranging for appointments and transportation to the primary- or tertiary-level facilities, if needed.

After the above, it's important to have a confidential, more detailed conversation. You, the provider, need to be as calm and supportive as possible: this is a very emotional and saddening conversation that must take place. Before initiating this conversation, you should ensure that it is a good time to do it; if the patient prefers another time, try to make plans for a short time after. You must make efforts to always talk truthfully but sensitively. There is no conflict between truthfulness and hopefulness.

Questions about how much time is left should be answered honestly (refer to the same information for tertiary-level providers, section 7.5.1).

For a patient who has been in hospital and is now back home, this is the time for health-care providers and caregivers at all levels to establish communication with each other and be kept informed about the patient and her course.

See Practice Sheet 7.3 for guidance on talking to a patient who is returning home under palliative care.



Counselling:
Palliative care

7.5.3 Discussing pain treatment with the patient and her family

When pain management is started, it is important to discuss this with the patient and her family. In particular the following aspects should be kept in mind:

- Inform the patient and her family that in most cases, pain and other symptoms of cancer can be controlled.
- Encourage the patient and her family to stay in contact with the community-based providers, especially if new symptoms appear or if pain is increasing.
- Describe what medicines are being prescribed for her, based on how severe the pain is, and tell her that she needs to keep you informed of how effective they are, because if they are not fully effective the pain medicines can be changed and/or their dose can be increased.
- Discuss with the patient traditional and non-clinical management options that can be used in addition to medicines.
- Reassure the patient and her support circle that strong pain medicines are being recommended and provided because she is experiencing pain, not because she is about to die.
- Reassure the patient and people in her support circle that dependence on strong pain medicines is rare.

- Provide the patient and her family with information on dosages, frequency of use, effectiveness, speed of expected relief, side-effects and how to prevent and manage them. Provide this information both verbally and in writing:
 - Constipation is almost always experienced. It can be managed by oral laxatives, and can be prevented if these medicines are taken from the beginning of treatment without waiting for the symptoms to start.
 - Nausea is less common, usually transient and can be treated with anti-emetics.
 - Euphoria and drowsiness are also usually transient; if severe or if they don't diminish with time, the provider will assist the patient with this, by very gradual dose reduction.
If these side-effects continues, the provider will seek advice from pain specialists.
- Inform the patient and her family of follow-up appointments, when and where (including at her home), even if there are no problems, and also how to arrange an appointment if they need to consult a doctor.
- Inform them of how they can reach clinical providers any time of the day or night (provide telephone numbers, etc.) in case of urgent questions, or severe or worsening problems.

7.5.4 Discussing approaching death with the patient and her family

It is important that the community and primary-level providers discuss with the patient and, if appropriate, with the patient's family and close support group, the probability that the patient may die very soon.

Cultural specifics have to be taken into account in the way discussions about imminent death are conducted. It is important not to say directly that the patient is dying, but rather to choose the right words with much care and say, for example, that you have noticed that she is becoming frailer and/or that she is noticeably less well. Reassure the patient's family that everybody is doing everything possible to keep her comfortable and that it is very important for her that they be by her side and provide love and anything that will make her feel cared for.

If possible, suggest that the patient's immediate support circle work with the patient to help her to contact people close to her who do not live nearby, and encourage them to assure her that they are willing and able to accomplish anything she feels should be done to make her life more satisfactory (e.g. resolving any present or old conflicts and taking care of commitments).

Keep the community workers who have been helping the patient informed of her status and request that they visit her daily if possible. Ask them to also inform the local primary

care provider about her status and, if necessary, request that the provider visits the patient at home.

7

Chapter 7. Palliative care

Reassure the family that you are and will be constantly available to see them and the patient for whatever reason. Also let the family know that after the patient, their loved one, has died, you will be there for them and support them during the grieving period, if they so wish.

Further reading

- Connor S, Egan K, Kwilosz D, Larson D, Reese D. Interdisciplinary approaches to assisting with end-of-life care and decision-making. *Am Behav Sci*. 2002;46(3):340–56.
- Minozzi S, Amato L, Davoli M. Development of dependence following treatment with opioid analgesics for pain relief: a systematic review. *Addiction*. 2013;108(4):688–98. doi:10.1111/j.1360-0443.2012.04005.x.
- Open Society Foundations (OSF). Public health fact sheet: palliative care as a human right. New York: OSF; 2011 (<http://www.opensocietyfoundations.org/publications/palliative-care-human-right-fact-sheet>, accessed 24 October 2014).
- Tassinari D, Drudi F, Rosati M, Maltoni M. Transdermal opioids as front line treatment of moderate to severe cancer pain: a systemic review. *Palliative medicine*. 2011;25(5):478–87.
- Wiffen PJ, McQuay HJ. Oral morphine for cancer pain. *Cochrane Database Syst Rev*. 2007(4):CD003868.
- World Health Organization (WHO). Cancer pain relief. Geneva: WHO; 1986 (http://apps.who.int/iris/bitstream/10665/43944/1/9241561009_eng.pdf, accessed 18 July 2014).
- World Health Organization (WHO). A community health approach to palliative care for HIV/AIDS and cancer patients in sub-Saharan Africa. Geneva: WHO; 2004 (<http://whqlibdoc.who.int/publications/2004/9241591498.pdf>, accessed 18 July 2014).
- World Health Organization (WHO). WHO model lists of essential medicines. Geneva: WHO; 2013 (<http://www.who.int/medicines/publications/essentialmedicines/en/>, accessed 22 October 2014).
- World Health Organization (WHO). Resolution WHA 67.19. Strengthening of palliative care as a component of integrated treatment throughout the life course. Sixty-seventh World Health Assembly, agenda item 15.5, Geneva, 24 May 2014. Geneva: WHO; 2014 (WHA 67.19; http://apps.who.int/gb/ebwha/pdf_files/WHA67/A67_R19-en.pdf, accessed 18 July 2014).
-



PRACTICE SHEETS

Practice Sheet 2.1: Checklist for planning and implementing a cervical cancer prevention and control programme¹

PLANNING the programme	
Establish a management team	
Engage local stakeholders	
Review and, if necessary, revise/update practice guidelines and protocols	
Assess the needs for providing HPV vaccination, screening and treatment services, and referrals at the local level	
Determine the size of the target populations for vaccination and screening, both in rural and urban areas	
Develop an action plan, including an information, education and communication (IEC) plan, a training plan, a service delivery strategy, local coverage goals for HPV vaccination, and a screening and treatment strategy	
Develop the budget and allocate resources to support implementation of the action plan	
Develop/update the IEC and training materials	
Provide orientation for the community, local stakeholders and staff	
Provide training and refresher training for health workers, supervisors and data managers	
Procure and distribute equipment and supplies	
Establish systems for quality management, including indicators, supportive supervision systems, and information systems to gather, store and communicate data at subnational and national levels	
Strengthen referral systems	
Launch the services	
IMPLEMENTING the programme	
Implement a strategy for community education and awareness-raising	
Deliver clinical services and ensure referrals	
Supervise the work of the providers and arrange on-site training and problem-solving as needed	
Monitor and evaluate the programme performance and outcomes based on the selected indicators	
Modify the strategy based on monitoring and evaluation results	

¹ *Source:* adapted from Planning and implementing cervical cancer prevention and control programs: a manual for managers. Seattle (WA): Alliance for Cervical Cancer Prevention; 2004 (http://www.rho.org/files/ACCP_mfm.pdf).

Practice Sheet 2.2: Key performance and impact indicators for national cervical cancer prevention and control programmes

This practice sheet lists the key performance, result and impact indicators for a cervical cancer prevention and control programme, and how to calculate each.

Core indicators for screening and treatment²

Note: This set of core indicators was developed for visual inspection with acetic acid (VIA) but can be applied to any other cervical screening test, as indicated by the wording below.

Core indicator 1: Screening rate (performance indicator)

What it measures: Percentage of women aged 30–49 years who have been screened for the first time with a cervical screening test in a 12-month period. This is a monitoring indicator that measures how many screenings were performed in a 12-month period targeting women aged 30–49 years.

Calculation:

Numerator: Number of women aged 30–49 years who have been screened for the first time with a cervical screening test in a 12-month period

Denominator: Number of women aged 30–49 years in the population.

Core indicator 2: Cervical screening test positivity rate (performance indicator)

What it measures: Percentage of screen-positive women aged 30–49 years with a positive result.

Calculation:

Numerator: Number of women aged 30–49 years reported positive in a 12-month period

Denominator: Total number of women aged 30–49 years screened in a 12-month period.

Core indicator 3: Treatment rate (performance indicator)

What it measures: Percentage of screen-positive women who have received treatment in a given year.

² Wording adapted from Annex 3 of: Monitoring national cervical cancer prevention and control programmes: quality control and quality assurance for visual inspection with acetic acid (VIA)-based programmes. Geneva: World Health Organization; 2013 (<http://www.who.int/reproductivehealth/publications/cancers/9789241505260/en/>).

Calculation:

Numerator: Number of screen-positive women aged 30–49 years completing appropriate treatment in a 12-month period

Denominator: Number of screen-positive women in a 12-month period.

Core indicator 4: Coverage of the target population (result indicator)

What it measures: Percentage of women aged 30–49 years who have been screened with a cervical screening test at least once between the ages of 30 and 49 years. This indicator measures the effectiveness of the screening programme in reaching the target population at least once.

Calculation:

Numerator: All women aged 30–49 that answered “Yes” to the question in the survey

Denominator: All women aged 30–49 that answered the question in the survey.

Core indicator 5: Age-specific cervical cancer incidence (impact indicator)

What it measures: Number of new cases of cervical cancer that occur in a defined population of disease-free individuals in a specified period of time.³

Calculation:

Numerator: Number of cases in the age group

Denominator: Number of women in the age group (1 person-year per person, if it is an annual measure).

Additional indicators for screening and treatment⁴

Note: This set of additional indicators was developed for visual inspection with acetic acid (VIA) but can be applied to any other cervical screening test, as indicated by the wording below.

1. Percentage of screen-positive women with lesions eligible for cryotherapy treated during the same visit

Calculation:

Numerator: Number of screen-positive women with lesions eligible for cryotherapy treated during the same visit $\times 100$

Denominator: Number of screen-positive women with lesions eligible for cryotherapy.

³ Boyle P, Parkin DM. Statistical methods for registries. In: Jensen OM et al., editors. Cancer registration: principles and methods. Lyon: International Agency for Research on Cancer (IARC); 1991:126–58.

⁴ Wording adapted from Annex 4 of: Monitoring national cervical cancer prevention and control programmes: quality control and quality assurance for visual inspection with acetic acid (VIA)-based programmes. Geneva: World Health Organization; 2013 (<http://www.who.int/reproductivehealth/publications/cancers/9789241505260/en/>).

2. Percentage of screen-positive women with lesions not eligible for cryotherapy referred to colposcopy and who complete adequate treatment

Calculation:

Numerator: Number of screen-positive women with lesions not eligible for cryotherapy referred to colposcopy and who complete adequate treatment $\times 100$

Denominator: Number of screen-positive women with lesions not eligible for cryotherapy.

3. Percentage of women with suspected invasive cancer on a cervical screening test who complete appropriate treatment or appropriate follow-up

Calculation:

Numerator: Number of women with suspected invasive cancer on a cervical screening test who complete appropriate treatment or follow-up $\times 100$

Denominator: Number of women with suspected invasive cancer on a cervical screening test.

Indicators for HPV vaccination

Coverage for HPV vaccination⁵

Fully vaccinated: Percentage of eligible girls in the target population who have received the two recommended doses in the HPV vaccine schedule (or three doses if applicable).

Calculation:

Numerator: Number of girls who received HPV2 (or HPV3 if applicable) $\times 100$

Denominator: Number of girls in the population eligible for HPV vaccination.

Rate of adverse events following immunization (AEFIs) for HPV vaccination

Number and percentage of vaccinated girls experiencing serious adverse events AND non-serious adverse events, as reported spontaneously through routine mechanisms of the country's immunization programme.

⁵ Refer to Annex 6: HPV immunization sample forms.

Indicators for cervical cancer care

Cervical cancer incidence: Age-specific cervical cancer incidence in a defined population of disease-free individuals in a given period of time.

Cervical cancer mortality: The number of deaths from cervical cancer occurring in a given period in a specified population.

Cancer treatment: Proportion of curable cancer patients who get adequate treatment (according to established standards) in a given period.⁶

Opioid access: Percentage of women with advanced cervical cancer who are receiving strong opioids in a given period, by treatment centre.

Calculation:

Numerator: Number of women receiving care at a treatment centre with advanced cervical cancer with pain as an identified problem who are being treated with a strong opioid, such as morphine

Denominator: Number of women receiving care at a treatment centre with advanced cervical cancer with pain as an identified problem.

Community-based care: Percentage of women with advanced cervical cancer who are referred for home-based care, including palliative care, in a given period.

Calculation:

Numerator: Number of women receiving care at a treatment centre with advanced cervical cancer who are referred for and able to receive home-based care, including palliative care

Denominator: Number of women receiving care at a treatment centre with advanced cervical cancer.

⁶ Diagnosis and treatment (Cancer control: knowledge into action: WHO guide for effective programmes: module 4). Geneva: World Health Organization; 2008 (http://www.who.int/cancer/modules/FINAL_Module_4.pdf).

Practice Sheet 3.1: Key messages for cervical cancer outreach and education

This practice sheet provides evidence-based messages for health educators. Providing accurate and easy-to-understand information is the first step in helping women and families access services that can prevent cervical cancer. You can use these messages to develop your health promotion talks.

Health education efforts should result in women and men being able to answer the following questions:

- WHAT is pre-cancer?
- WHAT is cervical cancer?
- HOW can cervical cancer be prevented?
- WHO should be vaccinated?
- WHO should be screened?
- WHICH prevention services are available locally?
- WHERE and WHEN can these local services be accessed?

Five key messages

You can prevent cervical cancer with vaccination, early detection and treatment! The following specific messages are the most important ones to convey within your community. Learn these five simple messages and use them consistently.

1. Cervical cancer is a disease that can be prevented.
2. There are tests to detect early changes in the cervix (known as pre-cancers) that may lead to cancer if not treated.
3. There are safe and effective treatments for these early changes.
4. All women aged 30–49 years should be screened for cervical cancer at least once.
5. There is a vaccine for girls that can help prevent cervical cancer.

More detailed cervical cancer messages to use in your health promotion talks

Who is at risk

- Cervical cancer is a leading cause of cancer death in women.
- Women 30–49 years old are most at risk for cervical cancer.
- Any woman who has had sexual relations is at risk of developing cervical cancer.

HPV infection

- Cervical cancer is caused by infection with a virus called HPV. This virus is passed during sexual relations and is very common among men and women.
- Almost all men and women will be exposed to HPV in their lifetime. Most HPV infections go away in a short time without treatment.
- In some women, HPV infection continues and can slowly change the cells on the cervix. These changes are called pre-cancer. If not treated, they can develop into cancer of the cervix.

Vaccination

- All girls should be vaccinated with the HPV vaccine at some time between the ages of 9 and 13.
- Vaccination prevents infection with the types of HPV that cause most cervical cancers.
- The HPV vaccines are safe and effective. Adverse reactions, when they occur, are usually minor.
- The HPV vaccine has no impact on a girl's fertility and does not affect her capacity to become pregnant and have healthy children later in life.
- The HPV vaccine, to be most effective, should be administered in accordance with the number and timing of doses as advised in the manufacturer's instructions (see Chapter 4, section 4.2.3).
- Even after vaccination, all women aged 30–49 years will require cervical cancer screening.

Screening and treatment

- There are screening tests for cervical cancer that can detect early changes of the cervix (pre-cancer).
- The screening tests for cervical pre-cancer are simple, quick and do not hurt.
- If the screening test is positive, it means that there could be early changes (pre-cancer) that can be treated. A positive screening test outcome DOES NOT mean cancer.
- To prevent cervical cancer, all women with positive screening tests should receive treatment.
- Women should have a screening test at least once between the ages of 30 and 49 years. It is important to follow the recommendation of the health worker as to when to return for screening.

- Women living with HIV are at higher risk for cervical cancer. Screening for cervical pre-cancer and cancer should be done in women and girls who have initiated sexual activity as soon as the woman or girl has tested positive for HIV, regardless of age; these women and girls living with HIV should be re-screened 12 months after treatment for pre-cancer, or within three years after negative screening results.

Signs and symptoms of cervical cancer

- Signs of cervical cancer include: foul-smelling vaginal discharge, vaginal bleeding, bleeding after sexual intercourse, or any bleeding after menopause. Women with these symptoms should seek medical care promptly.
- There are no signs or symptoms for the early changes of pre-cancer. Screening is the only way to know if you have pre-cancer.

Making decisions about health

- Women have a right to make their own decisions about their health. To make informed decisions, women need correct information.
- Women may wish to involve their partners or families in their decision-making. While screening for cervical cancer and treatment of pre-cancer are highly recommended, women should know they are free to refuse any test or treatment.

Practice Sheet 3.2: Frequently asked questions (FAQs) about cervical cancer

PS 3

Men and women, including health-care providers, often lack information on cervical cancer. This practice sheet lists some FAQs and provides answers. You and your colleagues should add other questions and answers relevant to the local situation.

It should be noted that some of the answers are repetitive so that when a question is asked, you do not need to go through all the answers in this practice sheet. If you familiarize yourself with all the information below, then, when asked a question, you will be able to quickly find the best answer for it.

Refer to Practice Sheet 4.1 for FAQs about HPV vaccination.



About cervical cancer

Q: What is cancer?

A: Cancer is the disease caused by uncontrolled growth of certain cells in the body, causing tumours or growths. Not all growths are cancer. When a cancer is allowed to grow and spread it can interfere with the normal functions of the body.

Q: What causes cervical cancer?

A: Cervical cancer is caused by infection with a virus called human papillomavirus or HPV. It is a very common virus that is passed during sexual relations, so most people will have it at some time in their lives. For most people, HPV will go away on its own, but in a small number of infected women the virus will persist. For these women, the virus can cause changes in the cells of the cervix which might develop into cervical cancer if they are not found during a screening test and removed.

Q: Does HPV cause any other diseases?

A: HPV can cause genital warts in both men and women. Genital warts are caused by different types of the HPV virus than cervical cancer. Genital warts will not turn into cancer, although they may require treatment if they do not go away on their own. In rare cases, HPV can cause other types of cancers, including cancer of the vagina, vulva, penis or anus.

Q: Who gets cervical cancer?

A: Almost all women who have had sexual relations, even without having had sexual intercourse, can be infected with HPV and are therefore at risk of cervical cancer. The women at greatest risk are those who have never been screened. Women who are living with HIV are also at greater risk because HIV makes them more likely to develop cancer when they are younger.

The good news is that most women's bodies will clear the HPV infection on their own and they will never get cancer, but screening is the only way to know who may develop the disease.

Because cervical cancer is not commonly found in women until they are in their 40s and 50s, the best time to screen for pre-cancer is between the ages of 30 and 49 years, before it becomes cancer.

Q: What can I do to prevent cervical cancer?

A: The most effective ways to prevent cervical cancer are for girls to get vaccinated before they start sexual activity and for women 30–49 years old to get screened.

If a woman's screening test is positive, she needs to be promptly treated. This can save her life. If the test is negative, it's a good idea to have repeat screenings, according to national guidelines.

If you have a daughter, make sure she receives all recommended doses of the HPV vaccine. Also, teach her about the importance of screening and early treatment when she is older.

All sexually active people should also practise behaviours that prevent the spread of sexually transmitted infections (e.g. delaying initiation of sexual activity, using condoms, and having as few sexual partners as possible). Smoking tobacco can increase the risk of cervical cancer in women infected with HPV.

About screening (early detection) and treatment

Q: What is cervical screening?

A: Cervical screening is the testing of all women at risk for cervical cancer to detect if they have pre-cancer. If pre-cancer is found and not treated it may progress to cancer in 10 or more years.

There are several very effective tests that can be used for screening, but depending on where you live and what is available, it is likely only one of them will be used.

Q: Who should be screened for cervical cancer?

A: Women between the ages of 30 and 49 years (or according to national guidelines) should have a screening test to detect early changes on the cervix, called pre-cancer. Screening for cervical pre-cancer and cancer should also be done in women and girls who have initiated sexual activity as soon as the woman or girl has tested positive for HIV, regardless of age; these women and girls living with HIV should be re-screened 12 months after treatment for pre-cancer, or within three years after negative screening results.

Q: I don't have any symptoms, why should I be tested?

A: The HPV virus lives in women's bodies for many years before it causes problems. After many years it starts to cause changes in the cells of the cervix, called pre-cancer.

Before they have developed cancer, most women with pre-cancer will not have any symptoms. You can have pre-cancer for 10–15 years without feeling anything abnormal before it becomes cancer.

When symptoms do occur – such as pain in the pelvic region or a foul odour from the vagina – they often are the result of advanced cervical cancer, which is difficult to treat. To avoid advanced cancer, women must be screened for pre-cancer at least once between the ages of 30 and 49 years and must be treated if there are signs of disease. Treatment of pre-cancer is easy and very effective.

Q: What is done during screening?

A: There are different tests that can be used. Your health-care provider will tell you about the test used at the local health-care facility. For most tests, the health-care provider will do a pelvic examination to gently swab the cervix. While the test is not painful, it can be a little uncomfortable to have a speculum in the vagina in order to see the cervix. Your health-care provider should try to make it as comfortable as possible for you. Some tests give the results right away and others require sending the sample to a lab and waiting for results.

Q: What if my test is negative?

A: If your screening test is negative, it means that you do not have any changes that might develop into cervical cancer. It is important to be screened every 5–10 years if possible to make sure any pre-cancer changes are caught early and treated right away.

Q: What if my test is positive?

A: In most cases, a positive screening test means you have pre-cancer, a condition that can be easily treated in a clinic setting.

In a few women, your health-care provider will want to do further testing to make sure that what you have is pre-cancer and not cancer. For those next steps, he or she may send you to another facility – a health centre or hospital. The provider may also refer you to a hospital for further care if he or she is not sure of the test results, or if he or she cannot provide the required treatment.

Note for the provider: Unless you have a definitive diagnosis of cancer made using tissue from the cervix, you should not tell the woman she might have cancer, because often the first impressions may be wrong and you may frighten her unnecessarily.

Q: Does a positive screening test mean that I have cancer? Does it mean that I will die from cervical cancer?

A: A positive screening test does NOT mean you have cancer. Most often it means you have something called pre-cancer, or early changes that could become cancer in many years if not treated. Pre-cancer is easy to treat and is curable. Often pre-cancer goes away following only one treatment.

Very rarely a woman is found to have signs of cervical cancer at the time of screening. If signs of possible cancer are found, your health-care provider will do further testing or will refer you to another health centre or hospital for testing and/or treatment. It is important to treat both pre-cancer and cancer.

A diagnosis of cancer does not mean you will die from it; if found early, it can be cured with available treatments.

Q: How do we treat pre-cancer?

A: If you have a pre-cancer, your health-care provider might be able to treat it on the same day as the screening. The most common treatment for pre-cancer is to freeze it, a treatment called cryotherapy. Cryotherapy is not painful, although like a pelvic examination it can be uncomfortable. It is very effective and safe. In most cases, your cervix will be healthy and normal after cryotherapy. Another treatment is loop electrosurgical excision procedure (LEEP), although it is often not available on the same day.

Q: Are screening tests painful? Is part of a woman's cervix or womb removed during screening?

A: Screening tests are painless, though you may feel a little uncomfortable during a pelvic examination. No part of the cervix or womb is removed during screening.

Q: Is one screening enough?

A: Having at least one screening between the ages of 30 and 49 years is good. Just one screening has been shown to decrease a woman's chance of dying from cervical cancer. However, if you have an option to be screened again, it is a best to be tested again every 5–10 years.

Q: I am too shy to show my private parts to a male doctor, what can I do?

A: It may be possible to find a female doctor or nurse who can provide pre-cancer screening. But if that is not possible, ask for a female health-care provider or a friend or family member to be in the room during the screening.

Even if you feel shy or embarrassed, please remember that the male and female providers are all trained in the same way and that their goal is to help you prevent cervical cancer. Do the right thing for yourself and for your family – get screened for pre-cancer and treated if you have it. Screening and treatment are not painful. If you do not get screened only because you are shy and the provider is a man, try to overcome this fear and remember that women with cervical cancer suffer much pain and can die from it.

Q: How similar is HPV to HIV, the virus that causes AIDS?

A: The two viruses – HPV (human papilloma virus) and HIV (human immunodeficiency virus) – are very different.

HPV is a much more common infection than HIV – almost everyone who is sexually active becomes infected with HPV at some point in his or her life. HPV lives on the skin and is transmitted when skin touches skin. HIV lives in body fluids like semen and blood, and is transmitted when those body fluids are exchanged between people; this is the reason that condoms are very effective at preventing HIV when sexual intercourse takes place.

However, condoms are not as good at preventing HPV infections because this virus can live on the skin. The best way to prevent HPV infection is through vaccination. Currently, no vaccine for HIV exists.

Common worries about cervical cancer**Q: I have heard that cervical cancer is caused by poor female hygiene or by using sanitary pads more than once. Is that true?**

A: No. Cervical cancer is caused by infection with HPV. The cancer has nothing to do with vaginal hygiene or sanitary pads.

Q: Is cervical cancer a sexually transmitted infection (STI)?

A: No. However, it is caused by HPV, which can be passed from one person to another during sexual relations. HPV is quite common in both men and women. Only a few women with HPV will get pre-cancer. If not treated, some of these women will develop cervical cancer many years after they were infected with HPV.

Q: Are women with many sexual partners at higher risk of HPV infection?

A: Yes. People with many sexual partners are at higher risk of all sexually transmitted infections.

The fewer sexual partners a person has, the less chance he or she has of becoming infected with any STI, including the many types of HPV, some of which cause cervical cancer.

Q: Is it true that only bad or loose women get cervical cancer?

A: No! All sexually active women are at some risk of cervical cancer. Being screened for pre-cancer can decrease this risk in women over 30, and giving the HPV vaccine to girls aged 9–13 years will decrease their risk as they grow up.

Q: Do intrauterine contraceptive devices (IUDs) or birth control pills cause cervical cancer?

A: No. IUDs and birth control pills DO NOT cause cervical cancer. They protect against unplanned pregnancies.

Practice Sheet 3.3: What men need to know to help prevent cervical cancer

This practice sheet provides basic information for reaching out to men and suggests ways to involve them in cervical cancer control.

Key messages for men

Men can play a very important role in the prevention and treatment of cervical cancer.

Men can:

- encourage their partners, sisters and mothers to be screened if they are 30–49 years of age;
- encourage their partners, sisters and mothers to be treated if pre-cancer or cancer is detected;
- encourage their daughters, sisters and female friends to get vaccinated with the HPV vaccine;
- use condoms to prevent all sexually transmitted infections (STIs), including HIV/AIDS, as well as pregnancy (condoms offer some protection against HPV);
- reduce the number of sexual partners they have, and use condoms if they have more than one sexual partner.

Basic information for men about cervical cancer

- Cervical cancer is exclusively a woman's disease, but men can play an important role in preventing and treating it.
- Most cervical cancer is caused by infection with a virus called HPV. The infection usually causes no symptoms or problems, but a few infected women will get pre-cancer many years later. If not treated, some of these women will develop cervical cancer.
- Infection with HPV is easily passed during sexual contact and therefore men can help to prevent it.
- Some types of HPV that do not cause cervical cancer can cause genital warts in both men and women, although the warts do not lead to cancer. In rare cases, the types of HPV that cause cervical cancer in women can also cause cancers of the mouth, anus or penis.
- HPV is transmitted sexually, but penetration is not the only mode of transmission as the virus can live on the skin around the genital area.

- Using a condom gives some protection but does not offer complete protection against HPV.
- Smoking tobacco can increase the risk of many cancers in men and women, including cervical cancer in women infected with HPV.
- A man whose partner is found to have pre-cancer or cancer can support and assist her in obtaining the recommended treatment, by accompanying her to clinic appointments and by learning about cervical cancer.
- A woman needs support (physical and emotional) when she is diagnosed and treated for pre-cancer or cancer.

Practice Sheet 3.4: Counselling

What is counselling?

Counselling is defined as advice or guidance (usually one-on-one) from a knowledgeable person to facilitate personal decision-making. Counselling is usually personal and confidential communication, aimed at helping a person and, in some circumstances, her family to make informed decisions and then to act on them, using a process of exchanging relevant and accurate information. To be an effective counsellor, you should have up-to-date knowledge, the ability to listen, and good communication skills. Drawings and illustrations, as well as the information provided in this guidance and in the practice sheets, may be useful counselling aids when talking to women about cervical cancer.

Basic questions about cervical cancer prevention that counsellors should answer for clients

- What and where is the cervix and how can it be examined?
- What is cervical cancer?
- What is cervical pre-cancer, or early cell changes, and how is this different from cancer?
- How can cervical cancer be prevented? (Explain how a simple screening test can detect pre-cancer BEFORE it becomes cancer.)
- Who is likely to get cervical cancer and who should be screened? (Explain that cervical cancer is not commonly found in women until they are in their 40s and 50s, so the best time to screen for pre-cancer is between the ages of 30 and 49, before it becomes cancer.)
- How accurate is the screening test? (Explain that no test is 100% effective in detecting a problem, but that the test you will be using will detect most early cell changes, also called pre-cancers.)
- Why is it important to have screening to detect pre-cancer? (Explain that treatment of pre-cancer is simple, safe and effective, and it can prevent them from getting cervical cancer and save their lives.)
- What treatment options are available for women who are found to have invasive cancer? (Explain that it is necessary to go to a tertiary care facility for treatment of cervical cancer; the type of treatment will depend on how advanced the cancer is.)

- What can be done to prevent cervical pre-cancer? (Explain that there is a vaccine available for girls aged 9–13 years that can help protect them from cervical pre-cancer and cancer).

Responsibilities of the counsellor

The counsellor must ensure that:

- the client understands the information and the choices she has;
- the communication is private (no one should be able to see or hear anything that goes on between the woman and the counsellor, unless specifically permitted by the woman);
- the information gathered during counselling and examination is kept confidential;
- mutual trust is established between counsellor and client;
- there is sensitivity in addressing and discussing private topics, particularly those related to sexuality and intimate behaviour.

Suggested steps when providing counselling

- Welcome the client warmly by name and introduce yourself.
- Sit close enough that you can talk comfortably and privately.
- If culturally appropriate, make eye contact; look at her when she is speaking.
- Assure her that nothing that is discussed will be repeated to anybody.
- Use language that she can understand and provide relevant information.
- Tailor the information you give and the discussion to the reason she is here today.
- Listen attentively and take note of her body language (posture, facial expression, eye contact).
- Be encouraging; nod or say, “Tell me more about that”.
- Try to identify her real, underlying concerns.
- Explain all the options available, discussing the benefits and limitations of each test or procedure.
- Always verify that she has understood what was discussed by having her repeat the most important messages or instructions.
- Help her come to a decision by providing clear information.
- Respect her choices.
- Invite her to return if and when she wishes.

Additional tips for good counselling

- Use a natural, understanding manner.
- Be empathetic: place yourself in the client's situation.
- Use approving body language (nod, smile, etc., as appropriate).
- Use visual aids, if available and appropriate.
- Ask open-ended questions to encourage her to talk.
- Encourage her to ask questions and then answer them truthfully.
- Allow enough time for the session.
- If she has doubts, invite her to return later to inform you of what she (and possibly her family) has decided.

Practice Sheet 3.5: Standard counselling steps for before, during and after a client has a test, procedure or treatment

Before

- Explain why it is important for the client to have the recommended test/procedure/treatment.
- Explain what will be done and how, what the results might be, and any potential need for future tests or treatments.
- Invite and respond to questions.
- For procedures and treatments, go through appropriate informed consent procedures according to country and facility recommendations (see Practice Sheet 5.1). If the treatment is vaccination and the client is under the legal age of consent, be aware that this step may include obtaining parental consent (see Chapter 4).
- Get information from the client on how you may contact her if follow-up is needed, including mobile phone details and times at which she may be safely called.



Informed consent

During

- Continue to engage the client in conversation while performing the procedure.
- Explain what you are doing at each step and show her any instruments or items that may be used.
- If what you are about to do may cause pain, cramps or other discomfort, warn her in advance and explain the potential severity and duration of the discomfort; this will help her feel comfortable.
- Reassure her that she can let you know when a step is painful.

After

- Explain what you did.
- Describe any noted abnormalities or reassure the woman that you did not see anything unusual.
- Agree on a date for a return visit, if necessary, and explain the importance of her returning to the clinic as planned.
- Encourage the client to ask questions and provide her with clear answers.

If the client needs to be referred to a higher level for further examination or testing

- Explain why, where and when the client must go, and whom she will see.
- Stress the importance of keeping this appointment.
- Answer any questions she has or, if you do not know the answer, find someone who does.
- Invite her to return if she has any questions or concerns about this appointment, and respond or find answers from someone who knows.

PS3

Practice Sheet 3.6: Special counselling for women living with HIV

Use Practice Sheets 3.4 and 3.5 as a guide to providing counselling. Please be sure to follow all the guidance on counselling when giving women their test results.



Counselling

When counselling a woman who is living with HIV, the following information should be provided in clear and simple language:



Counselling steps

- Women living with HIV are more likely to get HPV infection and to develop cervical cancer, but with extra care you can stay healthy.
- Cervical cancer develops more quickly in women living with HIV than in women who are HIV-negative, so it is important that you receive a screening test every year.
- The best way to prevent cervical cancer is to keep taking any medications that your health-care provider has recommended and to get screened every year for cervical cancer.
- If you have precancerous changes on your cervix, get treatment as early as possible.
- Follow your health-care provider's recommendations for caring for yourself after treatment for the pre-cancer.
- Please make sure to visit your health-care provider if you develop any foul-smelling or yellow or green discharge from your vagina or have unusual bleeding.

If a woman does not know her HIV status and lives in a country where HIV is prevalent, she should be encouraged to get tested and learn her HIV status. Because women who are living with HIV are more likely to develop cervical cancer when they have HPV infection, it is important to screen earlier and more often for cervical pre-cancer. Health-care providers should know the HIV testing sites in their community and where to refer a woman who is found to have HIV.

Practice Sheet 3.7: Working with community health workers: how to recruit and train

PS 3

Community health workers (CHWs) serve as a bridge between health services and the community and are recognized worldwide as an essential part of the health-care team. Because CHWs are established and valued community members, they can use their knowledge to engage all community members in cervical cancer prevention efforts, including talking to parents about the benefits of vaccination efforts as well as recruiting women for the screening programme.

Recruitment

If there is a cadre of CHWs already working on other health issues, it is best to utilize this existing resource rather than recruit new CHWs specifically for issues of cervical cancer.

If CHWs do not exist in your community, work with your clinic manager to determine if CHWs should be part of your programme.

Invite community leaders to help you identify potential recruits and consider creating a group that is representative of your community in terms of age, gender and ethnicity, in order to best reach all members of the community with information and/or services. Involve any existing networks of young peer educators to reach out to adolescents in the community – particularly those who are not in school – to promote vaccination. Train both men and women as CHWs, to improve your cervical cancer prevention efforts.

Individuals recruited as CHWs should have:

- good communication skills, including good listening skills;
- a desire to serve the community;
- the availability and interest in participating in the programme for at least 1–2 years, including attending workshops and meetings;
- a willingness to maintain confidentiality;
- an ability to maintain up-to-date information about the health-care facilities and services;
- the ability to read and write, if possible.

Training

Plan an interactive CHW training course for the new recruits. If possible, also include important community leaders in the training.

The training of new CHWs should cover:

- the basic facts about cervical cancer screening and treatment
- how to educate and mobilize the community
- how to prevent and manage misinformation and rumours
- the basics of effective communication and an opportunity to practice these skills
- record-keeping
- how to help women who require follow-up care.

The course should also include provision of relevant materials, and at the end should provide participants with a certificate acknowledging course completion.

Implementation

Plan for regular meetings with your team of CHWs. Health education and refresher training sessions serve as incentives for CHWs to continue their work and also help ensure that consistent and correct information is being provided to the community.

Resources for training community health workers

- Educational materials on training community health promoters are available in English and Spanish on request from PATH (info@path.org).
- Starr E, Burns A, Singer R. We can prevent cervical cancer: a course for community health promoters. Waterbury (VT): Grounds for Health; 2013 (available for download at: <http://www.groundsforhealth.org/publications/community-health-promoter-curriculum/>).
- Werner D, Bower B. Helping health workers learn: a book of methods, aids and ideas for instructors at the village level. Berkeley (CA): Hesperian; 1982, 2012 (available for purchase or download at: <http://hesperian.org/books-and-resources/>).

Practice Sheet 4.1: Frequently asked questions (FAQs) about HPV vaccination

Men and women, including health-care providers, often lack information on HPV vaccination. This practice sheet lists some FAQs and provides answers. You and your colleagues should add other questions and answers relevant to the local situation.

It should be noted that some of the answers are repetitive so that when a question is asked, you do not need to go through all the answers in this practice sheet. If you familiarize yourself with all the information below, then, when asked a question, you will be able to quickly find the best answer for it.

This practice sheet for providers assumes that most people may not know what causes cervical cancer; this probably is the case for parents of young girls in the target age. Therefore, for convenience, we provide fuller information on cervical cancer causation and prevention here, rather than referring to other sections of this document where that information is covered.

About HPV

Q: What is HPV?

A: Human papillomavirus, or HPV, is a common virus that is easily spread by skin-to-skin sexual contact with another person involving genital skin, even without sexual intercourse. Most HPV-infected people have no signs or symptoms, so it's possible to spread the infection to another person unknowingly. Most HPV infections are eliminated by the body in the first few years. Those that are not eliminated are termed "persistent" and may cause cervical cancer.

Q: Why are HPV vaccines needed?

A: HPV vaccines are needed because they greatly reduce the occurrence of cervical cancer, a principal cause of death from cancer among women in less developed countries.

Q: Do all women with HPV infection get cervical cancer?

A: No. In most women, HPV infections are eliminated by the body in the first few years. Among many different types of HPV only a few can cause cervical cancer if they are not eliminated by the body and persist for 10–20 years. Of the group of HPV viruses that cause cervical cancer, two of these – HPV types 16 and 18 – are the cause of 7 out of every 10 cervical cancers. Infection with these two HPV types can be prevented by HPV vaccination, so these vaccines can protect against 70% of cervical cancer if given as recommended.

In addition, cervical cancer can be prevented among women who have HPV infection if they participate in screening and treatment. If women aged 30–49

years are screened for changes in the cells of the cervix (pre-cancer), which are caused by persistent HPV infection, and treated as needed, then cervical cancer deaths would become rare even though HPV is common.

Q: How common is cervical cancer caused by HPV?

A: HPV is the main cause of cervical cancer. There are 528 000 cases of cervical cancer diagnosed each year. Of the 266 000 women who die every year from cervical cancer in the world, the great majority live in developing countries.

About HPV vaccination

Q: Will the HPV vaccines keep my daughter from getting cervical cancer?

A: Yes. The HPV vaccines prevent infection with the two types of HPV that cause most cervical cancers. All sexually active people should also practise behaviours that prevent the spread of sexually transmitted infections (e.g. delaying initiation of sexual activity, using condoms, and having as few sexual partners as possible).

Women who have been vaccinated should also be screened for cervical cancer when they are older.

Q: What HPV vaccines are currently available?

A: Two HPV vaccines are currently available worldwide. These vaccines are Cervarix® (made by GlaxoSmithKline) and Gardasil® or Silgard® (made by Merck).

Q: How are the two HPV vaccines similar?

A: Both vaccines provide very effective protection against 70% of potential cases of cervical cancer (because they both target HPV types 16 and 18).

Both vaccines are very safe.

Both vaccines cannot cause disease because they don't contain live viruses.

Both vaccines are given as injections (shots) and require two doses for girls younger than 15 years old, and three doses for immunocompromised girls (including those known to be living with HIV) and for girls aged 15 years and older.

Q: How are the two HPV vaccines different?

A: The vaccines are made up of different components to increase the body's production of antibodies.

One vaccine (Gardasil® or Silgard®) also provides protection against genital warts (because it also targets HPV types 6 and 11).

Q: Who should get vaccinated?

A: WHO recommends that girls should be vaccinated when they are aged 9–13 years. In our country, the guidelines specify that HPV vaccination should be given to girls aged ___ to ___ [OR all girls in year(s)/class(es)/grade(s) ___ at school]. The vaccines are not recommended in girls younger than 9 years of age.

Q: What is the recommended schedule (or timing) of the two-dose HPV vaccine schedule?

A: Two doses (shots/injections) are recommended for girls below 15 years of age, the second dose six months after the first. The provider who gives the vaccine will inform each girl who is vaccinated (and her parents) when she needs to return for the final dose. There is no maximum interval between the two doses; however an interval of not greater than 12–15 months is suggested. If the interval between doses is shorter than five months, then a third dose should be given at least six months after the first dose.

Q: What is the recommended timing of the three-dose HPV vaccine schedule?

A: When three doses are recommended (i.e. for girls aged 15 years or older, and for those known to be immunocompromised and/or HIV-infected, regardless of whether they are receiving antiretroviral therapy), the second dose should be received one or two months after the first dose (depending on the type of vaccine), and the third dose should be received six months after the first dose. The provider who gives the vaccine will inform each girl who is vaccinated (and her parents) when she needs to return for the next or final dose. It is not necessary to screen for HPV infection or HIV infection prior to HPV vaccination.

Q: Can HPV vaccines cure or get rid of HPV infections or cervical cancer, if a girl or woman is already infected with HPV when she gets the vaccine?

A: No. An HPV vaccine cannot cure HPV infections that may be present in a girl when she is vaccinated; neither can it cure cervical cancer or pre-cancer abnormalities, or prevent progression of disease in women who are already infected with HPV when they receive the vaccination.

Q: Will a woman between the ages of 30 and 49 years still need to be screened for pre-cancer and cancer even if she was fully vaccinated when she was a girl?

A: Yes! It is very important for adult women to get cervical cancer screening when they are 30–49 years old, even if they were previously vaccinated. This is because although the vaccine is very effective, it does not prevent infection from all types of HPV that cause cervical cancer.

Q: Can girls who are living with HIV be vaccinated?

A: Yes! Studies show that HPV vaccine is safe to administer to girls who are living with HIV. Vaccination for these girls is recommended prior to sexual debut, just as it is for all other girls. However, girls who are living with HIV should receive three doses of HPV vaccine, whether or not they are already 15 years old.

Q: Why are boys not vaccinated?

A: The vaccine does not harm boys; however, we are not recommending vaccinating boys now because the vaccines are rather costly and it's preferable to use available vaccines to protect those who are at risk of cervical cancer later in life (i.e. girls).

Common worries about HPV vaccination

Q: Are the HPV vaccines safe and effective?

A: Yes. Many studies conducted in developing and developed countries have found both vaccines to be very safe and effective. Both vaccines have been administered to millions of girls and women around the world without serious adverse events. As with all vaccines, the safety of these vaccines is monitored very carefully.

Common, mild adverse reactions include pain and redness where the shot was given, fever, headache and nausea. Sometimes girls who get the HPV vaccine (or other vaccines) faint, so girls should be watched for 15 minutes after vaccination; if they feel faint they should lie down to avoid getting hurt.

Q: Why do people faint after getting HPV vaccines?

A: Adolescents are particularly prone to fainting after any medical procedure, including receiving vaccines, because they are often very nervous before coming into the vaccination room. To prevent falls and injuries due to fainting, ask the girl receiving the vaccine to be sitting before, during and for 15 minutes after the vaccine is given.

Q: My daughter is too young to be having sex – why is HPV vaccine recommended for such young girls?

A: For the HPV vaccine to work best, it is very important to vaccinate girls before they have any sexual contact with another person.

This is because a young girl can be infected with HPV even the very first time she has sexual contact (even just skin-to-skin contact near the vagina and penis). Also, tests have shown that the vaccine produces better protection from HPV infection when given at this age compared to older ages. The vaccines cannot treat a girl who is already infected with HPV.

Q: Will HPV vaccination affect my daughter's fertility? Will it be more difficult for her to become pregnant or to carry a pregnancy to term?

A: No! There is no evidence that HPV vaccination will affect a girl's future fertility or cause any problems with future pregnancies.

Q: Are all recommended doses needed for my daughter to be fully protected from HPV? Isn't one dose enough?

A: Like some other vaccines, the HPV vaccine requires more than one injection. Without all the recommended doses, the vaccine might not be completely effective in preventing cervical cancer. It is important that your daughter receives all doses and observes the minimum and maximum intervals between the doses, in order to be fully protected.

Q: Is HPV vaccine safe in pregnancy?

A: HPV vaccines are not recommended for use in sexually active or pregnant girls or women. However, studies have shown that the vaccine causes no problems for the mothers or the babies born to women who received the HPV vaccine during pregnancy.

If a girl or woman receives the HPV vaccine when pregnant, this is not a reason to consider ending a pregnancy. But, to be on the safe side, until more is known, girls and women should not be vaccinated while pregnant.

Q: Are there any contraindications to being vaccinated?

A: If a girl has had a serious allergic reaction to another vaccine or a previous dose of the HPV vaccine, then she should not receive HPV vaccine, to avoid serious reactions.

Note for the provider administering the vaccine: Request the opinion of a medical doctor before vaccinating a girl who has had previous allergic reactions to a vaccine.

Practice Sheet 4.2: HPV vaccine characteristics and the cold chain

This practice sheet is only for the provider

Presentation/appearance of HPV vaccines

- Gardasil® is available in one size only, as a single-dose vial, which contains a 0.5 ml suspension, without any preservatives or antibiotics. These can be ordered in packages of 1, 10 and 100 vials.
- Cervarix® is available in two sizes: the single-dose vial has a rubber stopper and contains a 0.5 ml suspension, without any preservatives or antibiotics. The two-dose presentation contains a 1.0 ml suspension, without preservatives or antibiotics. Both sizes can be ordered in packages of 1, 10 and 100 vials.
- Both of the HPV vaccines, when they arrive or after refrigerated storage, will have settled into two layers: a clear liquid on top and a white deposit at the bottom of the vial. They need to be shaken every time before transferring them to the syringe, mixing the two layers into a suspension.

Vaccination schedule

HPV vaccinations are recommended for girls aged 9–13 years old.

- **A two-dose schedule** with an interval of six months between doses is recommended for girls aged < 15 years (including those girls aged ≥ 15 years at the time of the second dose).
- There is no maximum interval between the two doses; however, an interval of not greater than 12–15 months is suggested.
- If for any reason the interval between the first and second doses is shorter than five months, then a third dose should be given at least six months after the first dose.
- **The three-dose schedule** (0, 1–2, 6 months) remains recommended for girls aged ≥ 15 years and for immunocompromised individuals, including those known to be living with HIV. (regardless of whether they are receiving antiretroviral therapy). It is not necessary to screen for HPV infection or HIV infection prior to HPV vaccination.

These schedule recommendations apply to both the bivalent and quadrivalent vaccines.⁷

⁷ For further information please see the *Meeting of the Strategic Advisory Group of Experts on immunization, April 2014 – conclusions and recommendations*, available at: <http://www.who.int/wer/2014/wer8921.pdf>

Vaccine storage and the cold chain

Both HPV vaccines are sensitive to freezing; if frozen, they need to be discarded because they will no longer provide protection. Therefore, the following should be noted:

- They need to be kept at 2–8°C.
- HPV vaccines cannot be placed in or near the freezer compartment of the refrigerator nor directly on a frozen ice pack.
- The vaccines should not be kept in the refrigerator door, as the temperature there is more likely to fluctuate when opening and closing the refrigerator.
- The temperature of the refrigerator should be monitored by checking the thermometer regularly (at least twice daily) and by keeping a Freeze-tag® or Fridge-tag® in the refrigerator to detect if freezing temperatures have occurred. If the temperature is above 8°C or below 2°C, it needs to be adjusted as necessary to maintain the appropriate temperature.
- Both vaccines should be administered as soon as possible after being removed from the refrigerator. Opened vials of the product should be discarded at the end of the immunization session or after six hours, whichever comes first.
- If transport of vaccine is required, the thermos box needs to maintain a temperature of 2–8°C.
 - Be aware that there is a considerable risk of freezing when using frozen ice packs. Therefore, frozen ice packs should be kept at room temperature for at least 5–10 minutes (until the ice inside them can be heard to move when shaken) before placing the vaccines and ice packs in the thermos. This is called “conditioning” the ice packs and it prevents the vaccine from freezing when it is placed near the ice packs. Always separate the conditioned ice packs from the vaccines with a sufficiently thick appropriate material. Remember that the risk of freezing is the most serious risk for a freeze-sensitive vaccine.
 - For brief excursions from the cold storage refrigerator, consider using water packs instead: these are ice packs kept at a temperature between 2°C and 8°C.
- Both vaccines are sensitive to light and should be stored in the original package until ready to use.

How to verify if a vaccine was previously frozen

If a supply of HPV vaccine is suspected to have been frozen or exposed to sub-zero temperatures, a shake test should be performed to determine whether the vaccine can be used or not. If it has been frozen, the vaccine when shaken will not appear

PS 4

as a uniformly white suspension; rather, there will be obvious particles floating in the liquid. Another sign of previous freezing is that the liquid may have changed colour.

For more details, refer to the article in the Bulletin of the World Health Organization on *Validation of the shake test for detecting freeze damage to adsorbed vaccines* (Kartoglu et al., 2010; see full reference details in the list of further reading at the end of Chapter 4),⁸ and view two online instructional videos: *Shake and tell* (22 minutes) and *Step by step shake test* (10 minutes).⁹

According to the manufacturers' inserts, the shelf life after the vaccine is produced is three years for single-dose vials of Gardasil[®], four years for single-dose vials of Cervarix[®] and three years for two-dose vials of Cervarix[®].

Important: Check the expiry date on the vaccine packages to be used before initiating a vaccination session. If the expiry date has passed, the vaccine needs to be discarded.¹⁰

A vaccine vial monitor (VVM) is a label that will change colour based on temperature (i.e. it is thermochromic). A VVM is put on vials containing vaccines and gives a visual indication of cumulative heat exposure, which degrades the vaccine. If the inner square of the VVM matches or is darker than the outer ring, discard the vaccine.

Vaccine interchangeability

It is preferable to use the same vaccine for all doses as there are no data on the interchangeability of the two HPV vaccines. However, if the vaccine used for prior doses is unknown or unavailable locally, either of the marketed HPV vaccines can be administered to complete the schedule.

⁸ Available at: <http://www.who.int/bulletin/volumes/88/8/08-056879/en/index.html>

⁹ Available at: <http://vimeo.com/8381355> (*Shake and tell*); <http://vimeo.com/8389435> (*Step by step shake test*)

¹⁰ Further information available at: <http://www.ema.europa.eu/ema/>

Practice Sheet 4.3: The immunization session

Preparation

School-based strategy

If a school-based strategy is to be implemented or if the school has volunteered to provide a venue for out-of-school girls, a pre-visit may be required. School officials and teachers who will be involved in vaccination activities must be informed of details for the vaccination days, and may also need training before they can provide assistance (refer to Practice Sheet 4.7). WHO has a school vaccination readiness assessment tool that is available to assist planners using a school-based delivery strategy.¹¹



Teachers
and schools

The day before vaccination or early the same day

Ensure the following are available:

- vaccine and syringes, cool box and ice packs for transport
- information, education and communication materials (e.g. flyers, pamphlets, posters)
- chair and table
- waste bin for non-sharp disposables (e.g. swabs, paper towels)
- water and soap (or alcohol-based handrub) for washing hands
- trays and kidney dishes
- safety boxes with closed lids
- containers for used vials
- swabs for cleansing the injection site before and after vaccinating
- medicines to manage allergic reactions according to national guidelines
- place for girls to rest during and for 15 minutes after vaccination
- vaccination logbook (register)
- tally sheets
- personal vaccination cards
- calendar.

¹¹ Available at: http://www.who.int/immunization/hpv/plan/school_readiness_assessment_tool_who_2013.pdf

Implementation

Before administering vaccine

The health-care provider or other trained adult/teacher should determine that the girl is eligible for HPV vaccination and that she understands what is about to be done. Depending on national guidelines, the provider should also know whether or not eligible girls may refuse to be vaccinated.

1. Greet the girl (and her parent/guardian, if present).
2. Explain the purpose and benefits of HPV vaccination.
3. Discuss the potential risks and adverse events or reactions associated with vaccination.
4. Discuss the risks of not receiving the vaccine.
5. Ask the girl (and/or her parent/guardian, if present) if she has any questions and answer them clearly, using the minimum amount of technical language.
6. Check that the girl understands the information provided and correct any misunderstandings. If after receiving the information, the girl refuses to be vaccinated, her wishes should be respected; allow her to leave after inviting her to return at another time to discuss the decision further.
7. Collect written consent from the parent/guardian, if applicable.
8. Verify eligibility by checking that the girl:
 - is within the target age
 - is not pregnant (this information should be asked in private)
 - is not allergic to any component of the vaccine.
9. Ask to see the girl's vaccination card (or adolescent health card) if available for verification.
10. Determine which HPV vaccine dose will be administered during this session.

Safely administering the vaccine to eligible girls

11. Make sure the girl is seated to minimize the risk of harm from possible fainting.
12. Check the expiry date on the vial.
13. Check the vaccine vial monitor (VVM).
14. Hold the vial between the thumb and middle finger and check its condition: do not use if the package is punctured, torn or damaged, or if the vial contains particles, or if there is discolouration or ice formation.
15. Perform the shake test if freezing is suspected (see Practice Sheet 4.2).



HPV vaccine

16. Mix the vaccine suspension by shaking the vial until the liquid is white and cloudy.
17. Open the auto-disable syringe package and remove the syringe and needle.
18. Take off the needle cap without touching any part of the needle.
19. Insert the needle into the vaccine vial and bring the tip of the needle to the lowest part of the bottom of the vial.
20. Draw the entire contents of the vial into the 0.5 ml syringe until you notice a “click”.
21. Inject the entire contents of the syringe into the deltoid muscle of the upper arm using a perpendicular 90 degree angle.
22. Place a swab on the injection site and ask the girl to hold it there firmly; do not massage the injection site.

After administering the vaccine

23. Discard the syringe and needle in the safety box immediately after administration.
24. Record the information on the girl’s personal vaccination card (see Annex 6, Sample Form 6.1).
25. Determine the due date for the next vaccine dose and also record it on the vaccination card.
26. Remind her that she must receive the remaining dose(s) and schedule her for her next vaccination.
27. Document the girl’s vaccination on the appropriate forms.
28. Document the following information in the vaccination logbook (register) (see Annex 6, Sample Form 6.2):
 - a. name of girl
 - b. address
 - c. date of birth and age (if unknown, document the girl’s age based on an educated guess)
 - d. date of vaccination
 - e. HPV dose number: HPV1 or HPV2 (or HPV3, if applicable)
 - f. date for the next dose, if needed
 - g. date of previous dose(s), if applicable.
29. Return updated vaccination card to the girl, show her where you have marked the appointment for the next dose and ask her to bring it back at that time.
30. Observe the girl for 15 minutes after administration, in case of fainting.
31. Manage and document any adverse reaction.



HPV immunization
sample forms

Practice Sheet 4.4: Injection safety

WHO defines a safe injection as one that:

- does not harm the recipient
- does not expose the health worker to any avoidable risks
- does not result in waste that is dangerous to the community.

Injection safety can be improved by adherence to the following practices:

1. Always follow manufacturer recommendations for use, storage and handling.
2. Wash hands with soap and water, and drip dry.
3. Prepare injections in a clean designated area where exposure to blood and body fluid is unlikely.
4. Prepare each dose immediately before administering; do not prepare several syringes in advance.
5. To minimize risk of injury, prepare the work area such that:
 - a. the vaccine administrator is placed between the girl and the needles and other sharp objects;
 - b. monitoring tools and safety boxes are easily accessible; and
 - c. each vaccinator has a designated safety box and can see the entrance hole when discarding needles.
6. Check the vial for condition and expiry date, and check the vaccine vial monitor (VVM).
7. Do not use the vaccine if the package is punctured, torn or damaged, or if the vial contains particles or if there is discolouration (see Practice Sheet 4.2).
8. Use a new auto-disable syringe for each girl.
9. Do not touch any part of the needle.
10. Never leave the needle in the top of the vaccine vial.
11. Clean the injection site and inject the entire contents of the syringe into the deltoid muscle of the upper arm using a perpendicular 90 degree angle.
12. Do not recap the needle after use.
13. Discard the syringe and needle in a safety box immediately after administering the vaccine (a safety box is a waterproof and tamper-proof container that is securely closed with only a small hole at the top, large enough for syringe and needle to go through).
14. Do not overfill the safety box. Close the container and seal the opening when the box is three quarters full. Do not try to pack the contents down by pushing into the box opening.
15. Keep safety boxes in a dry, safe place until they are safely disposed of as directed in your facility.
16. Never dispose of used syringes and needles in an open box or container.



HPV vaccine

Practice Sheet 4.5: Monitoring and evaluation of vaccination programmes – data collection and documentation

PS 4

Assessing HPV vaccine coverage is necessary for monitoring the performance of a vaccination programme, as well as for evaluating the impact of the vaccine on a population.

Since HPV vaccination is recommended as a two-dose series of vaccines administered with a six-month interval to adolescent girls aged 9–13 years, monitoring will require collection of coverage data by dose and by age. At a minimum, the girl's date of birth or age, date of vaccine administration, and dose number should be recorded each time a vaccine is administered.

Please refer to Annex 6, Sample Forms 6.1–6.4.

The WHO Human papillomavirus (HPV) vaccine coverage monitoring tool is available with instructions for local adaptation and use.¹² Below is a brief summary of the contents and instructions.



HPV immunization sample forms

Data collection and reporting tools

For vaccine providers:

- personal immunization (adolescent health) cards (Sample Form 6.1)
- vaccine provider logbook, one for each service delivery site (Sample Form 6.2)
- tally sheet, one for each vaccination session (Sample Form 6.2)
- monthly record sheet of vaccination days, one for each service delivery site (Sample Form 6.3)
- adverse event following immunization (AEFI) reporting form (see Practice Sheet 4.6, and Sample Form 6.4).



AEFIs

For supervisors:

- service delivery site monthly summary table for each calendar year.

For district health offices:

- district health office monthly summary table for each calendar year
- district health office annual reporting form.

For national health offices:

- national health office monthly summary table
- national health office annual reporting form.

¹² Available at: <http://www.who.int/immunization/diseases/hpv/resources/en/>

Data collection procedures

1. Use one logbook (register) at each service delivery site.
2. Register each girl by collecting the following information:
 - a. name of girl
 - b. address
 - c. date of birth and age (if unknown, document the girl's age based on an educated guess)
 - d. date of vaccination
 - e. HPV dose number: HPV1 or HPV2 (or HPV3, if applicable)
 - f. date of previous dose(s), if applicable
 - g. age at previous dose(s), if applicable.
3. Ask the girl privately if she is or thinks she might be pregnant; if so, postpone her vaccination and record this fact in the logbook.
4. Ask the girl to present her personal vaccination card. Check the logbook (register) to verify which dose is being given. If she doesn't have her card, check the logbook using her personal information.
5. Register each dose administered by marking through one zero in the appropriate box (based on age and dose number) on the standard tally form (see Annex 6, Sample Form 6.2).
6. At the end of the vaccination day, tally up the number of HPV doses given, by dose number and by age, then count and record the number of strike-throughs on the tally form for each dose number and age category; if the subtotal is zero, record the number 0 with a strike-through (Sample Form 6.2).
7. The sample forms only offer a model; if standardized nationally or internationally accepted forms exist, these should be used instead.



HPV immunization sample forms

An AEFI can be described as an adverse clinical event that is temporally related to vaccination but that may or may not be caused by the vaccine or the vaccine process. AEFIs can range from minor events, such as a mild reaction at the injection site, to life-threatening events, including anaphylaxis, and possibly death. Although an AEFI can be caused by the vaccine itself, reported AEFIs are, more commonly, a coincident event not related to the vaccine but caused by programmatic or human errors that compromise the vaccine quality. Monitoring HPV vaccine safety and reporting incidents in great detail are of particular importance because this is a relatively new vaccine and is administered to an age group not previously targeted for vaccination. Any adverse reaction can destroy the trust that parents and communities have placed in the vaccine and in the vaccination programme and staff.

Practice Sheet 4.6: In case of an adverse event following immunization (AEFI)

An AEFI can be described as an adverse clinical event that is temporally related to vaccination but that may or may not be caused by the vaccine or the vaccine process. AEFIs can range from minor events, such as a mild reaction at the injection site, to life-threatening events, including anaphylaxis, and possibly death. Although an AEFI can be caused by the vaccine itself, reported AEFIs are, more commonly, a coincident event not related to the vaccine but caused by programmatic or human errors that compromise the vaccine quality. Monitoring HPV vaccine safety and reporting incidents in great detail are of particular importance because this is a relatively new vaccine and is administered to an age group not previously targeted for vaccination. Any adverse reaction can destroy the trust that parents and communities have placed in the vaccine and in the vaccination programme and staff.

AEFIs can be classified into five categories:¹³

1. Vaccine product-related reaction: An AEFI that is caused or precipitated by a vaccine due to one or more of the inherent properties of the vaccine product (e.g. extensive limb swelling following DTP vaccination).
2. Vaccine quality defect-related reaction: An AEFI that is caused or precipitated by a vaccine due to one or more quality defects of the vaccine product, including its administration device as provided by the manufacturer (e.g. failure by the manufacturer to completely inactivate a lot of inactivated polio vaccine leads to cases of paralytic polio).
3. Immunization error-related reaction: An AEFI that is caused by inappropriate vaccine handling, prescribing or administration, which thus by its nature is preventable (e.g. transmission of infection by contaminated multidose vial).
4. Immunization anxiety-related reaction: An AEFI arising from anxiety about the immunization (e.g. fainting in an adolescent during/following vaccination).
5. Coincidental event: An AEFI that is caused by something other than the vaccine product, immunization error or immunization anxiety (e.g. a fever occurs at the time of the vaccination but is in fact caused by malaria).

¹³ Further information on WHO's classification of AEFIs is available at: <http://vaccine-safety-training.org/classification-of-aefis.html>

HPV vaccine reactions

Common HPV vaccine reactions

These reactions usually resolve spontaneously and rarely require treatment:

- redness, pain, swelling or induration at the injection site
- fever
- headache, muscle pain, bone pain
- nausea, vomiting, diarrhoea, abdominal pain
- fainting.

Rare HPV vaccine reactions

Serious adverse events are extremely rare, and require immediate treatment.

Anaphylaxis can be causally related to HPV vaccination and therefore precautions should be taken to avoid vaccinating girls who have had previous allergic reactions to vaccine components. If vaccination anaphylaxis is suspected, the girl should immediately be treated as needed. These girls should not receive subsequent HPV vaccine doses or other vaccines that contain similar vaccine components.

AEFI reporting

A system should be in place to facilitate prompt reporting and investigation of AEFIs. National regulatory authorities and national immunization technical advisory groups (NITAG) should take a proactive role in investigating reports of serious AEFIs to verify whether or not there is a link to HPV vaccine and develop communication messages to address rumours.

All suspected AEFIs should be immediately reported to health authorities using a standard AEFI reporting form (see, for example, Annex 6, Sample Form 6.4). Serious events such as death, hospitalization or a geographic cluster of AEFIs should be rapidly investigated (within 48 hours).



HPV immunization sample forms

Handling rumours

Groups opposed to all vaccines may initiate or perpetuate rumours of risks related to vaccines and spurious associations with coincident adverse events to discourage HPV vaccination in the population. Because misinformation can be detrimental to vaccine acceptability and vaccination efforts, a robust AEFI monitoring infrastructure is essential as a basis for dispelling rumours and demonstrating continued safety of HPV vaccines. Having a plan in place to stress the safety of the HPV vaccine and dispel rumours is an important component of a successful HPV vaccination programme.

Practice Sheet 4.7: Talking with teachers and school officials about HPV vaccination

PS 4

Some days (or weeks) before a scheduled vaccination session for schoolgirls, a meeting should be held with the objective of educating the school staff about the HPV vaccine. It can be suggested that they adapt some of what is discussed using appropriate language when talking with their students (boys and girls) before the first vaccination session. Make an appointment for this meeting through the school administration and suggest that all teachers be invited. The following suggestions for meeting preparation, presentation and follow-up may be helpful.

What to bring

- Information and education materials
- Copies of the frequently asked questions and answers to distribute (see Practice Sheets 3.2 and 4.1).

Topics and activities for the meeting

- After introductions, divide into subgroups of 4–6 participants; if possible have one school administration staff representative in each group.
 - Distribute one or both FAQ sheets to each group and ask a volunteer in each group to lead a discussion on the topics covered.
 - A volunteer from each group can then give a summary of what was not understood in their group.
 - Provide information to address these issues.
 - If everything was understood, ask if there are any other questions, and discuss them.
 - Continue with A or B (below), as appropriate.
- A. If the school is not going to be a vaccination venue, before thanking those present and closing the meeting, provide information on where and when the vaccinations will take place and who should attend (girls aged 9–13 years, with consent from a parent/guardian).
- B. If the school is going to be a vaccination venue (and it is assumed that this has been previously discussed and agreed between the school administrative staff and the health service representatives), then add the following to the meeting:
- Have an interactive/participatory discussion on:
 - when the vaccination sessions will be conducted (i.e. dates of the two sessions as well as mop-up sessions after each of the main sessions, if possible);
 - who the providers will be;

PS 4

- who will assist during the sessions (e.g. one or two volunteers from the school staff); and
 - where at the school the vaccination session should take place (including requirements for space and furniture).
- In some schools, the teachers may be trained to help enrol the girls and check that they meet eligibility criteria, that they have parental consent and that they assent to receive the vaccine.
 - Leave a copy of the practice sheets on what needs to be in place before the vaccination session (Practice Sheets 4.3, 4.4 and 4.5).
 - Before thanking those present and leaving, inform them that you would appreciate it if you can come the day before the session and meet with one of the school volunteers to visit the site and ensure that everything is in place as required.



Immunization session



Injection safety



M & E

WHO has a school vaccination readiness assessment tool that is available to assist planners using a school-based delivery strategy.¹⁴

¹⁴ Available at: http://www.who.int/immunization/hpv/plan/school_readiness_assessment_tool_who_2013.pdf

Chapter 5 Practice Sheets

Notes for the provider

Before conducting any of the procedures described in Chapter 5:

1. Please be familiar with all the information on the female anatomy in Chapter 1, section 1.2.
2. Review the information on infection prevention and control in Annex 3, and ensure that you always have the necessary supplies available in the examination room.
3. Obtain informed consent as directed in Practice Sheet 5.1.



Infection prevention
and control



Informed consent

PS5

Practice Sheet 5.1: Obtaining informed consent from adult women

What is informed consent?

Before performing any procedure (i.e. test, diagnostic or treatment procedure), a woman (and her family if she wishes) should receive sufficient information about the specific procedure suggested for her and should agree or accept the procedure (see Practice Sheets 3.4 and 3.5 on counselling). The information should include a description of the procedure, why it is appropriate for her, the time it takes and the level of discomfort or pain it may cause, and any possible complications that may follow. The information should also include a discussion of the meaning and implications of a positive result (in the case of a screening test or diagnostic procedure), available alternative procedures, and possible consequences if she refuses the procedure.



Counselling



Counselling steps

After receiving the necessary information, the client is able to make an **informed choice** about whether to accept or refuse the proposed procedure. If she accepts, she needs to provide explicit **informed consent**. For screening, diagnosis and treatment procedures, consent can generally be verbal, with the exception of cold knife conization (CKC), for which hospital guidelines will usually require written consent.

Additionally, if there is a possibility that the client might need to be contacted at home or at work (e.g. to give test results or to remind her to return for an appointment), the provider should obtain consent for doing so. Information collected should include how to contact the client (e.g. personal visit by a community worker, mail, telephone, etc.), and the best days and times for contacting her.

Principles of informed consent

It is unethical to ask for informed consent retroactively, that is, after the procedure has been conducted.

When asking for informed consent, the following must be kept in mind:

- Maintaining privacy is key.
- Be clear and direct; do not use words the client will not understand, or which are vague, such as “growth” or “neoplasm”.
- Draw or use pictures to illustrate your explanations.

- Cover all the important issues.
- Allow some time for the client to take in what you have said, then let her ask questions.
- Clarify and correct any misunderstandings she might have.
- When all the questions and concerns have been addressed, ask the client for her formal consent.
- It might be culturally important to include others, such as the client's partner, in the decision-making process; however, you should ensure that the woman's own wishes are respected.

Explaining tests and procedures to clients

You will find explanations for clients included in each chapter of this guidance and in the practice sheets. You may adapt these to individual situations to help explain procedures in terms the client and her family will understand.

Practice Sheet 5.2: Taking a history and performing a pelvic examination¹⁵

Taking a history

Cervical cancer screening and treatment include taking a history to assess if the woman has specific risk factors or suggestive symptoms. Some of the listed information for a history is very important in some cases, but requesting it can be difficult because of common inhibitions about discussion of sexual matters. The provider should be prepared with culturally sensitive and appropriate language before asking questions to obtain this information.

Before starting

You need to have the following equipment and supplies:

- a clinical chart and a pencil
- illustrations of pelvic organs, if possible
- soap and water (or alcohol-based handrub) for washing hands
- a bright light source to examine the cervix
- an examination table covered by clean paper or cloth
- disposable or high-level disinfected examination gloves*
- specula of different sizes, high-level disinfected (need not be sterile)*
- a small container of warm water to lubricate and warm the speculum
- 0.5% chlorine solution for decontaminating instruments and gloves.

* invasive procedures such as loop electrosurgical excision procedure (LEEP) and cold knife conization (CKC) require the use of sterile equipment.

Information to obtain from the client

- age, education, number of pregnancies, births and living children, last menstrual period, menstrual pattern, previous and present contraception;
- previous cervical cancer screening tests, their dates and results;
- medical history, including any medications or allergies to medicines;
- behavioural factors that may increase her risk of cervical cancer (e.g. smoking tobacco);
- any symptoms and signs of cervical cancer and other illnesses;

¹⁵ *Source*: adapted from (1) Burns AA, Lovich R, Maxwell J, Shapiro K, Niemann S, Metcalf E, editors. Where women have no doctor: a health guide for women. Berkeley (CA): Hesperian Foundation; 1997; and (2) Sexually transmitted and other reproductive tract infections: a guide to essential practice. Geneva: World Health Organization; 2005 (<http://whqlibdoc.who.int/publications/2005/9241592656.pdf>).

- and, if the situation and cultural context allow: sexual history, including age of sexual initiation and of first pregnancy, number of partners, previous sexually transmitted infections (STIs), and any behaviours that may suggest an increased risk of cervical cancer.

Performing a pelvic examination

After taking a history, perform a pelvic examination. There are three components to the female pelvic examination:

- an external genital examination
- a speculum examination
- a bimanual examination.

Preparation

1. Have all necessary equipment and supplies ready. Ensure the speculum to be used is at a comfortable temperature.
2. If tests or interventions are planned (e.g. screening with acetic acid, treatment of pre-cancer with cryotherapy), tell the client what they are, what they are for, and when you expect to have the results.
3. Ask the client if she has any questions, and answer them truthfully. If you do not know the answer, tell her that you will try to get the answer for her before she leaves the facility.
4. Explain what the pelvic examination consists of and show the client a speculum.
5. Ask the client to empty her bladder (urinate) and have her undress from the waist down. Be particularly sensitive to her sense of modesty about uncovering normally clothed areas.
6. Position the client on the examination table.

External genital examination

7. Use gloves on both hands. Using a gloved hand to gently touch the woman, look for redness, lumps, swelling, unusual discharge, sores, tears and scars around the genitals and in between the skin folds of the vulva. These can be signs of an STI.

Speculum examination

8. Hold the speculum blades together sideways and slip them into the vagina. Be careful not to press on the urethra or clitoris because these areas are very sensitive. When the speculum is halfway in, turn it so the handle is down. Gently open the blades and look for the cervix. Move the speculum slowly and gently until you can see the entire cervix. Tighten the screw (or otherwise lock the speculum in the open position) so it will stay in place.
9. Check the cervix, which should look pink, round and smooth. There may be small yellowish cysts, areas of redness around the opening (cervical os) or a clear mucoid discharge; these are normal findings.

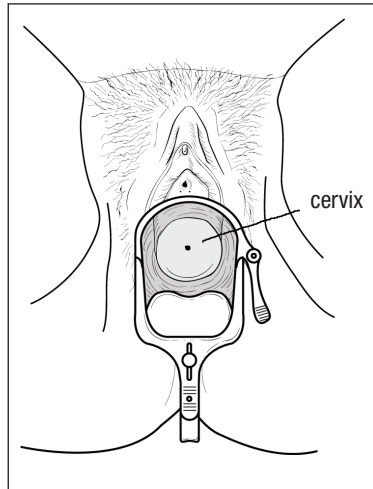
Figure PS5.2.1: The speculum examination

10. Look for any abnormalities, such as:
 - vaginal discharge and redness of the vaginal walls, which are common signs of vaginitis (if the discharge is white and curd-like, there may be a yeast infection);
 - ulcers, sores or blisters, which may be caused by syphilis, chancroid, herpes (the most common reason) or, in some cases, cancer;
 - easy bleeding when the cervix is touched with a swab, or a mucopurulent discharge, which are both signs of a cervical infection;
 - an abnormal growth or tumour, which might be cervical cancer and usually requires a biopsy (see Practice Sheet 5.7).
11. Gently pull the speculum towards you until the blades are clear of the cervix, close the blades and remove the speculum.



Counselling: +ve

Bimanual examination

The bimanual examination allows you to feel the reproductive organs inside the abdomen.

12. Test for cervical motion tenderness. Put the pointing and the middle finger of your gloved hand in the woman's vagina. Turn the palm of your hand up. Feel the cervix to see if it is firm and round. Then put one finger on either side of the cervix and move the cervix gently while watching the woman's facial expression. If this causes pain (you may see the woman grimace), this indicates cervical motion tenderness, and she may have an infection of the womb, tubes or ovaries (i.e. pelvic inflammatory disease, or PID). If her cervix feels soft, she may be pregnant.
13. Feel the uterus by gently pushing on her lower abdomen with your other hand. This moves the womb, tubes and ovaries closer to the fingers inside her vagina. The womb may be tipped forwards or backwards. When you find the womb, feel for its size and shape. It should feel firm, smooth and smaller than a lemon.
 - If the uterus feels soft and large, the woman is probably pregnant.
 - If it feels lumpy and hard, she may have a fibroid or other growth.
 - If it hurts her when you touch it or move it from side to side, she may have an infection.
 - If it does not move freely, she may have scars from an old infection.

Figure PS5.2.2: The bimanual examination

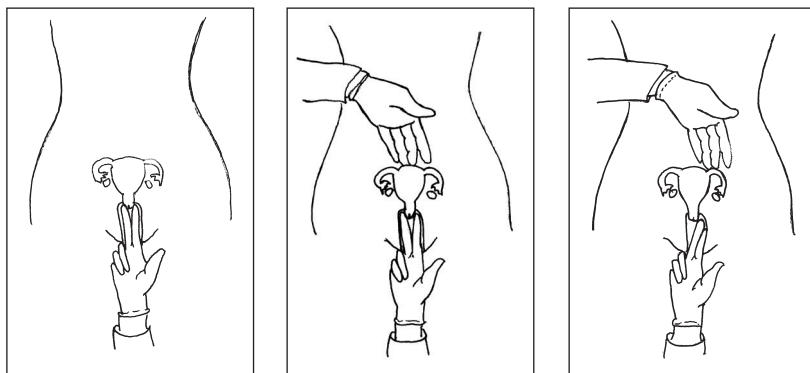

14. Feel the tubes and ovaries. If these are normal, they will be hard to feel. If you feel any lumps that are bigger than an almond or that cause severe pain, she may have an infection or other condition needing urgent treatment. If she has a painful lump, and her period is late, she may have an ectopic pregnancy; in this case, she needs immediate medical help.

15. Move your fingers to feel the inside of the vagina. Make sure there are no unusual lumps, tears or sores (you probably noticed them during the speculum examination).
16. Ask the woman to cough or push down as if she were passing stool. Look to see if something bulges out of the vagina. If it does, she may have a fallen womb or fallen bladder (prolapse).

After the examination

17. Place used equipment and gloves in decontamination solution.
18. Wash your hands with soap and water.
19. Record all findings on the client's chart.
20. Tell the woman whether her examination was normal or you noted anything unusual or abnormal, and explain what any abnormality you noted might mean.
21. If you noted any signs that might indicate an STI, treat the woman and her partner immediately, according to national or WHO guidelines.¹⁶ Provide condoms and teach them how to use them. See Annex 12 on treatment of cervical infections and PID.
22. If you found something that needs urgent treatment or that cannot be handled at your centre (e.g. suspicion of ectopic pregnancy, prolapse, cervical tumour), refer the client to a higher level of care.
23. If you performed any test (e.g. HPV screening, LEEP, biopsy, Pap smear) that needs to be sent to a laboratory, tell her when she should return or call for the results.
24. If necessary, give the client a date to return for follow-up.



Treatment of infections

¹⁶ Management of sexually transmitted infections: regional guidelines. New Delhi: World Health Organization Regional Office for South-East Asia; 2011 (<http://www.searo.who.int/entity/hiv/documents/9789290224105/en/>).

Practice Sheet 5.3: Screening methods: notes for the provider

In the following pages, you will find three detailed practice sheets related to the most commonly used cervical screening tests:

Practice Sheet 5.4: Molecular screening method – HPV DNA testing

Practice Sheet 5.5: Visual screening method – visual inspection with acetic acid (VIA)

Practice Sheet 5.6: Cytology-based screening methods – Pap smear and liquid-based cytology (LBC)

Which test to use: In your practice area, you may only have the option of one or two of these test methods. The test or tests to be used are determined at the central level based on the test characteristics, including effectiveness, equipment and training requirements and cost, as well as the sustainability of implementing a screening programme using each test or combination of tests. It may be the case that different tests are selected for use in predominantly urban areas and predominantly rural areas. See Annexes 7–9 for WHO evidence-based pre-cancer screen-and-treat flowcharts.

Training considerations: Whichever test you will be using in your area, the procedure needs to be conducted by a health-care provider who has been adequately trained to implement the most up-to-date national guidelines on the subject. Providers who lack such training should request for their training to be brought up to date, including a component of observed practice. Providers also need to be familiar with the existing referral system and the official procedures for documenting screening activities.

Age and frequency of screening: For WHO recommendations on age and frequency of cervical screening, including recommendations for women living with HIV, please review the information in Chapter 5, section 5.2.5, in this guidance.

Finally, remember: Your work is not complete until patients (at least those with an abnormal test result) have received the test result and have been counselled about its meaning and the necessary next steps, including the need for treatment following abnormal test results in women aged 30–49 years old.



Decision-making flowchart



Screen & treat strategies HIV–



Screen & treat strategies HIV+

Practice Sheet 5.4: Molecular screening method – HPV DNA testing

For HPV DNA testing, secretions are collected from the cervix or vagina using a swab or small brush (which may be included in the test kit – see manufacturer's instructions) and then placed into a container with a special liquid. This container will be sent to the laboratory where the sample will be analysed for the presence of HPV DNA. An HPV test that can be analysed at the facility where the sample was taken, with less sophisticated equipment, is currently being tested and may soon be available.

A negative result indicates that no HPV infection was found, while a positive result indicates an infection with one or more of the high-risk HPV types.¹⁷ When a woman over 30 years old receives a positive HPV test result, follow-up management according to the national guidelines is required.

Important: The test does not diagnose cervical pre-cancer or cancer and the provider should not say it does this when explaining the test to a patient.

Counselling steps specific to the HPV test are included in the procedure as outlined in this practice sheet. Refer to Practice Sheets 3.4 and 3.5 for suggestions on providing counselling to clients on cervical cancer and specifically before performing any examination, test or procedure, and see Practice Sheet 3.6 on special counselling for women living with HIV.



Counselling



Counselling steps



HIV Counselling

Taking a sample for HPV testing

The sample can be collected with or without a speculum examination and can be collected by a health-care provider or by the client herself.

Without using a speculum in the vagina, a provider can collect the sample by inserting a long swab all the way to the top of the vagina, twirling it around and placing it in the appropriate solution. This can also be done by the woman herself, after providing her with instructions and the necessary supplies: a long swab and a container of the solution.

¹⁷ Seven out of 10 (70%) of all cervical cancer cases reported throughout the world are caused by only two types of HPV: 16 and 18. Another four high-risk HPV types – 31, 33, 45 and 58 – are less commonly found to be associated with cervical cancer (see Chapter 1, section 1.3.4). HPV tests can detect all of these high-risk types.

If the sample will be taken during a pelvic examination (see Practice Sheet 5.2), the following equipment and supplies are needed:

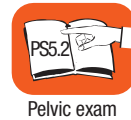

- soap and water for washing hands
- a light source to examine the cervix
- an examination table covered by clean paper or cloth
- a speculum, high-level disinfected (it need not be sterile)
- disposable or high-level disinfected examination gloves
- a small brush or soft swab
- a small container with preservative solution
- a recording form and a pencil
- a small container of warm water to lubricate and warm the speculum
- 0.5% chlorine solution for decontaminating instruments and gloves.

Note: It is best not to take a sample from a woman who is actively menstruating. Slight bleeding is acceptable.

Preparation

1. Explain what an HPV test is and what a positive test means. Ensure that the woman has understood and obtain informed consent.

Taking the sample

By a health-care provider, with or without using a speculum in the vagina:

2. Take a smear from the top of the vagina using a brush or swab.
3. Place the brush or swab in a special container with preservative solution.

Self-collection of the sample by the **client**:

- i. Explain to the client how to collect her own sample, in accordance with the manufacturer's instructions.
- ii. Provide her with swabs and a labelled vessel with preservative solution.
- iii. She can collect the specimen in the clinic, if there is a private area, or at home.
- iv. If she collects the specimen at home, it should be brought back to the facility within the time frame specified by the manufacturer of the test kit and the client should be informed when to return for the test results.

After taking the sample

4. If a speculum was used, gently close and remove it, and place it in decontamination solution.

PS5

5. Label the container with the client's name, clinic record number, and the date.
6. Tell the client about anything unusual you noted, particularly if the sample was taken using a speculum. If you saw something for which you wish to refer the woman to a higher-level facility, explain why, where and when she must go, and whom to see; stress the importance of keeping this appointment.
7. Record the taking of the sample on the patient chart, along with any observations.
8. Tell the woman when to return for the test results.

Follow-up: providing the client with her test results at the next visit

- When giving the client her test result, explain what it means and, if necessary, advise her on any additional follow-up tests or treatment.
- If the test was used as a primary screening tool, a woman with a positive test result should be advised on the next steps according to your national guidelines.
- Be prepared to respond to questions concerning the implications of a positive HPV test.

See Practice Sheet 5.7: Counselling women after positive screening test results.



Counselling: +ve

Practice Sheet 5.5: Visual screening method – visual inspection with acetic acid (VIA)

To conduct VIA, the provider applies 3–5% acetic acid to the cervix, and then looks to see if any white changes appear after waiting for 1–2 minutes. The VIA test is positive if there are raised and thickened white plaques or acetowhite areas that last more than one minute, usually near the squamocolumnar junction (SCJ). VIA is negative if the cervical lining shows no changes.

The provider should suspect cancer if a cauliflower-like (fungating) mass or ulcer is noted on the cervix. In these cases, VIA is not conducted and the client needs to be referred directly to a higher-level facility.



Counselling

Refer to Practice Sheets 3.4 and 3.5 for suggestions on providing counselling to clients on cervical cancer and specifically before performing any examination, test or procedure. Practice Sheet 3.6 provides counselling information specific for women living with HIV.



Counselling steps

The following equipment and supplies are needed for VIA:

- soap and water (or alcohol-based handrub) for washing hands
- a bright light source to examine the cervix
- a speculum, high-level disinfected (need not be sterile)
- disposable or high-level disinfected examination gloves (need not be sterile)
- an examination table covered by clean paper or cloth
- cotton-tipped swabs
- dilute acetic acid solution (3–5%) or white vinegar
- a recording form and a pencil
- materials for infection prevention:
 - 0.5% chlorine solution for decontaminating instruments
 - bags for contaminated disposable supplies.



HIV Counselling

Note: Visual methods are not recommended for use in postmenopausal women if the entire transformation zone is not visible on a speculum exam.

Preparation

1. Before starting, review what the client knows about VIA and correct or add to this information as needed and ask if she has any questions. Explain the procedure,

PS5

how it is done, and what a positive test means. Ensure that the woman has understood and obtain informed consent.

2. Do a speculum examination as described in Practice Sheet 5.2, and keep the speculum in place to perform the VIA test.



Pelvic exam

Performing the screening test

3. Adjust the light source in order to get the best view of the cervix.
4. Use a cotton swab to remove any discharge, blood or mucus from the cervix.
5. Confirm that you are able to see the entire transformation zone and identify the SCJ and the area around it.
6. Apply acetic acid to the cervix.
7. Important: wait 1–2 minutes to allow changes to develop.
8. Inspect the SCJ carefully and be sure you can see all of it. Look for any raised and thickened white plaques or acetowhite epithelium, giving special attention to the transformation zone.
8. Use a fresh swab to remove any remaining acetic acid from the cervix and vagina.
9. Gently close and remove the speculum, and place it in decontamination solution.

After screening

10. Record your observations and the result of the test. Draw a map of any abnormal findings on the record form, as shown in Figure PS5.5.1.

Figure PS5.5.1: VIA results recorded on a labelled drawing

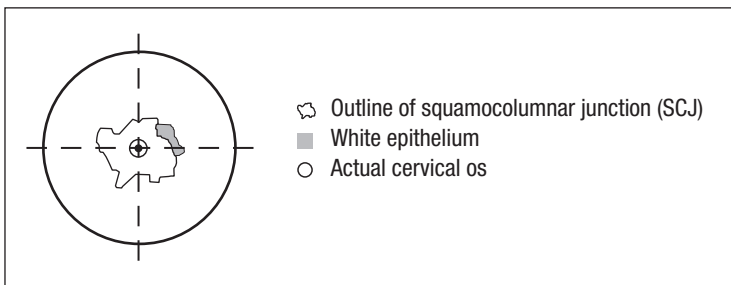

11. Discuss the results of the screening test with the client.
 - If the test is negative (normal), tell her that she should have another test in 3–5 years, or as national guidelines recommend.
 - If the test is positive (abnormal), tell her that she needs to be treated and discuss this with her; emphasize that the test does not prevent or treat cervical cancer or pre-cancer but that treatment for pre-cancer is the key to prevention after a

positive result (see Practice Sheet 5.7: Counselling women after positive screening test results).

- If cancer is suspected, tell her what the recommended next steps are. She needs to be referred for further management (testing and treatment). Make arrangements and provide her with all necessary forms and instructions before she leaves. If you can make the appointment immediately, do so.



Counselling: +ve

PS 5

PS5

Practice Sheet 5.6: Cytology-based screening methods – Pap smear and liquid-based cytology (LBC)

There are two ways to conduct cervical cytology screening: a conventional Pap smear or liquid-based cytology (LBC). Both methods use a sample of cells taken from the cervix during a pelvic examination using a speculum. For a Pap smear, the sample is smeared onto a slide, fixed, and then examined under a microscope. For LBC, the sample is transferred to a special preservative solution and transported to the laboratory for processing.

When abnormal epithelial cells are found on cytology screening, it is reported as positive. But most positive findings are not cancer; they are related to abnormalities that range from inflammations secondary to a cervical or vaginal infection to pre-cancer ranging from mild to severe (see Annex 5: The 2001 Bethesda System).



Bethesda System

Therefore, most women with a positive result on cytology screening need more tests to confirm the diagnosis (including a repeat Pap smear, VIA, colposcopy, biopsy and/or endocervical curettage) and to determine whether treatment is needed.

The following equipment and supplies are needed for taking a sample for cervical cytology:

- soap and water (or alcohol-based handrub) for washing hands
- a bright light source to examine the cervix
- an examination table covered by clean paper or cloth
- a speculum, high-level disinfected (need not be sterile)
- disposable or high-level disinfected examination gloves (need not be sterile)
- an extended-tip wooden or plastic spatula or a brush for sampling (see Figure PS5.6.1)
- For Pap smear only: a glass slide with frosted edge, and fixative spray or solution
- For LBC only: a tube containing a special preservative solution
- a recording form, a pencil for labelling
- a small container of warm water to lubricate and warm the speculum
- 0.5% chlorine solution for decontaminating instruments and gloves.

Figure PS5.6.1: Devices for cervical sampling for cytology-based screening

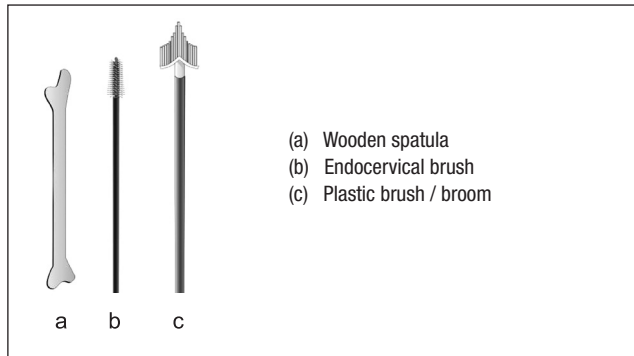
**Notes:**

- It is best not to take a cervical sample from women who are actively menstruating or have symptoms of an acute infection. Slight bleeding is acceptable.
- Pregnancy is not an ideal time to take a cervical sample for cytology screening, because it can give misleading results. However, if the woman is in the target age group and it is likely that she will not return after giving birth, proceed with the smear.

Counselling steps specific to cytological screening are included in the procedure as outlined in this practice sheet. Refer to Practice Sheets 3.4 and 3.5 for suggestions on providing counselling to clients on cervical cancer and specifically before performing any examination, test or procedure. Practice Sheet 3.6 provides counselling information specific to women living with HIV.



Counselling



Counselling steps



HIV Counselling

Conventional Pap smear**Preparation**

1. Explain the procedure, what a positive or negative test result will mean, and why it is important to return for the test results and act on them appropriately. Ensure that the woman has understood and obtain informed consent.
2. Do a speculum examination, as described in Practice Sheet 5.2.



Pelvic exam

Taking the sample

3. Insert the long tip of the spatula or brush into the cervical os, and rotate it through a full circle (360 degrees) (see Figure 5.6.2).

Figure 5.6.2: Taking a sample of cervical cells with a wooden spatula

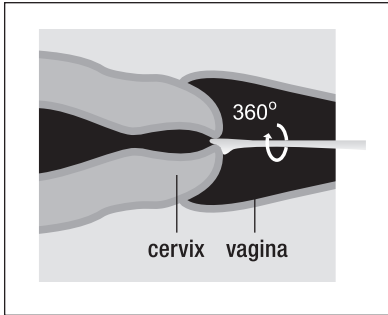

4. Smear both sides of the spatula onto the glass slide with one or two careful swipes (or roll the brush onto the slide). If you see any abnormalities outside the area sampled, take a separate specimen and smear it onto another slide.
5. Immediately fix each slide, even before removing the speculum from the vagina – it only takes a few seconds: either use a spray fixative, at a right angle to and a distance of 20cm from the slide (see Figure 5.6.3), or immerse the slide in a container of 95% ethanol and leave it there for at least five minutes (while you proceed with the next steps).
6. Gently close and remove the speculum.

Figure 5.6.3: Fixing a conventional Pap smear using a spray fixative

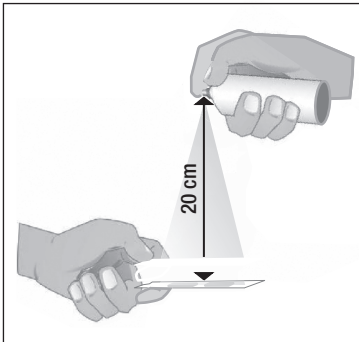

Note: If the slide is not fixed immediately, the cells will dry and become misshapen; this will make it impossible to read the slide accurately in the laboratory.

After taking the sample and preparing the slide

7. Place all used instruments in decontamination solution.

8. Label the frosted edge of each slide carefully with the client's name, clinic record number, and the date.
9. On the patient record, note and illustrate any features you noticed, including: visibility of the transformation zone, inflammation, ulcers or other lesions, abnormal discharge. Note whether other samples were taken (e.g. a Pap smear of another area and any STI tests) and note if the woman has been referred elsewhere (to whom and when).
10. Ask the client if she has any questions and provide clear answers.
11. Tell her when and how she will receive the test results and stress the importance of returning for her results. Ideally, results should be sent back to the clinic from the laboratory within 2–3 weeks. It is not acceptable for the laboratory to take more than a month before reporting back.
12. If you saw something for which you wish to refer the woman to a higher-level facility, explain why, where and when she must go, and whom to see; stress the importance of keeping this appointment.

Liquid-based cytology (LBC)

This method is a refinement of the conventional Pap smear. There are some differences in the steps to be followed – especially for taking and preparing the sample. As with Pap smears, specimens are also sent to the laboratory for processing, and the results are also reported in the same manner.

Preparation

1. Explain the procedure, what a positive or negative test result will mean, and why it is important to return for the test results and act on them appropriately. Ensure that the woman has understood and obtain informed consent.
2. Do a speculum examination, as described in Practice Sheet 5.2.



Pelvic exam

Taking the sample

3. Insert the brush or spatula into the cervical os, and rotate it through a full circle (360 degrees).
4. Take the specimen from the brush or spatula and transfer it to the special preservative solution in a tube.
5. Gently close and remove the speculum.

After taking the sample

6. Place all used instruments in decontamination solution.
7. Label the container carefully with the client's name, clinic record number, and the date.

PS5

8. On the patient record, note and illustrate any features you noticed, including: visibility of the transformation zone, inflammation, ulcers or other lesions, abnormal discharge. Note whether other samples were taken (e.g. any STI tests) and note if the woman has been referred elsewhere (to whom and when).
9. Ask the client if she has any questions and provide clear answers.
10. Tell her when and how she will receive the test results and stress the importance of returning for her results. Ideally, results should be sent back to the clinic from the laboratory within 2–3 weeks. It is not acceptable for the laboratory to take more than a month before reporting back.
11. If you saw something for which you wish to refer the woman to a higher-level facility, explain why, where and when she must go, and whom to see; stress the importance of keeping this appointment.

Follow-up: providing the client with her cytology test results at the next visit

- When the client returns, give her the test results, explain what they mean, and advise her on the next steps that need to be done.
 - If the test is negative (normal), advise her to have another screening test in 3–5 years, or as national guidelines recommend.
 - If the result is positive (abnormal), use the flowcharts in Annexes 8 and 9 as a guide for advising her on the necessary follow-up care.
- If the client does not return, and her smear was abnormal or inadequate for laboratory analysis, try to contact her.

Practice Sheet 5.7: Counselling women after positive screening test results

Refer to Practice Sheets 3.4 and 3.5 for guidance on how to provide counselling.



Counselling

Counselling women after positive test results that are NOT suspicious for cancer



Counselling steps

When explaining to a woman that her screening test was positive, but NOT suspicious for cancer, the following information should be provided in clear and simple language:

1. Congratulate her for taking care of her health and explain that this test helps to PREVENT cervical cancer from occurring.
2. Tell her that her test was positive and explain what this means, while reassuring her that it does NOT mean she has cervical cancer.

In the case of a **positive cytology or VIA test:**

- Explain to her that the test looks for early changes, called pre-cancer, which could one day become cancer if left untreated.
- Explain that there is simple and safe treatment available to remove the early changes, which is very effective in curing these pre-cancers.

In the case of a **positive HPV test:**

- Explain to her that a positive HPV test means that there is an infection with the virus present in her cervix. Reassure her that very few HPV-positive women develop cervical cancer.
 - If she has a positive HPV test and a negative VIA test, explain to her that this means that she has a persistent infection with HPV, but that it has not yet caused cell changes.
3. Explain what the treatment is (if any), how long it will take, and what she can expect.
 4. Emphasize the fact that if she does not receive treatment (or close follow-up, in the case of a positive HPV test combined with a negative VIA or cytology screening test), years later, she could develop cervical cancer.
 5. Explain that if she wishes she can be treated today (i.e. the same day), or as soon as possible, or she can be referred elsewhere for treatment. Make an appointment if needed.

Further information in the case of a positive HPV test

Even though a positive HPV test result does not mean that the woman will develop cervical cancer or have any problems in the future, or that she has pre-cancer,

PS5

it might still be upsetting for her to hear that she is HPV-positive. Answer any questions that the patient has about HPV infection, and provide her with the following general information:

- HPV is passed during sexual activity, but it is impossible to know when or from whom you got it (unless you have had sexual contact with only one partner in your life).
- HPV is not a sign of promiscuity or infidelity.
- HPV is very difficult to prevent. While condoms do protect against HIV and unwanted pregnancy, they do not provide complete protection from HPV.
- Being HPV-positive or being treated for it will not make it difficult to get pregnant or to have a healthy baby.
- Although the names are similar, HPV is not related to HIV.



Counselling



Counselling steps



FAQs

Please refer to Practice Sheet 3.4 for how to provide counselling about cervical cancer in general and to Practice Sheet 3.5 for information on counselling before, during and after a test or procedure. Refer to Practice Sheet 3.2 for answers to common questions about HPV.

Counselling women after positive test results that ARE suspicious for cancer

1. Explain to the client that her screening test was positive for changes to the cervix and that she needs additional tests to learn more about these changes.
2. Do NOT tell her you think she has cancer; this needs to be determined with a biopsy.
3. Ask her if she has someone with her today and ask if she wants them to join you to hear the information you need to give her about the next steps.
4. Reassure her that although there is a concern, the most important thing is that she came for screening and now she can be helped.
5. Explain to her that in most cases there is treatment that can cure her; that is what she needs to focus on.
6. Give her information for a referral appointment and be sure that you have all of her contact information in case you need to get in touch with her.

7. Ask her if there are any problems that may prevent her from going to the referral appointment; if there are, discuss possible solutions and help her make a plan to obtain the services she needs.
8. Set a date to follow-up with her to make sure she received the necessary care.

The provider plays an important role in ensuring that a woman with results that are suspicious for cancer receives the follow-up care that she needs. Providers should:

- Consider setting up a system to track all referrals so as to ensure that clients receive the necessary additional testing and treatment.
- Ensure that the woman and her family members understand the importance of going to all appointments and following the instructions provided by all the health-care providers involved in her care.
- Follow-up with the woman, and her family, to make sure that they understand the outcome of her additional testing and treatment.

Practice Sheet 5.8: Colposcopy

What is colposcopy and why is it needed?

Colposcopy is the use of a colposcope (an instrument that provides magnification and a bright light) to look at the cervix.

Colposcopy is not often done because it requires the patient to go through an additional step, which may only be available at a distant facility and at additional cost, possibly resulting in loss to follow-up.

The reasons for ordering colposcopy include:

- to assist with treatment using cryotherapy or LEEP by mapping the site, size and location of the pre-cancer;
- to guide biopsies of areas that appear abnormal and may be cancer.

Important: When talking with the patient, the provider must not mention cancer, because until the results of the microscopic examination are received, the diagnosis is not known.

The following equipment and supplies are needed for colposcopy:

- vaginal speculum – high-level disinfected
- colposcope
- all necessary supplies for infection prevention.

And, because biopsies and/or endocervical curettage (ECC) are usually performed during colposcopy, you may also need:

- 3–5% acetic acid
- Monsel's paste (see Annex 13)
- punch biopsy forceps
- endocervical curette
- ring forceps
- cotton swabs
- specimen bottles with 10% formalin
- pencil and labels.



Monsel's paste

Preparation

1. Explain the procedure, what the tests may show, and why it is important to return for further management as requested. Ensure that the patient has understood and obtain informed consent.
2. Show the patient the colposcope and explain how you will use it to examine her.
3. Prepare the patient for a pelvic examination (see Practice Sheet 5.2).

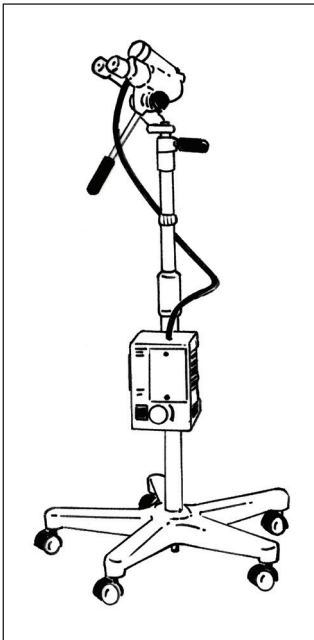
Figure PS5.8.1: Colposcope**Procedure**

Tell the patient what you will do at every step, and warn her before you do anything that might cause cramps or pain.

4. Insert a speculum and make sure the posterior fornix (vaginal space surrounding the ectocervix) is dry.
5. Inspect the cervix at low-power magnification (5x to 10x), looking for any obvious areas of abnormality, including ulcers, growths suspicious for cancer, cysts, warts, etc. Identify the transformation zone and the original and new squamocolumnar

junctions (SCJ). If advisable, or if the entire SCJ is not visible, you can inspect the cervical canal using an endocervical speculum. If the entire SCJ is still not visible, the colposcopic procedure is termed inadequate or unsatisfactory, and an ECC should be done (see Practice Sheet 5.9).

6. Apply saline to the cervix. Inspect the cervix with a green filter at 15x magnification, noting any abnormal vascular patterns.
7. After telling the patient that she might feel a mild stinging sensation, apply acetic acid.
8. Wait 1–2 minutes to allow colour changes to develop; observe any changes in the appearance of the cervix. Give special attention to abnormalities close to the SCJ.
9. Integrate the findings of the saline test and the acetic acid test to make a colposcopic assessment.
10. If biopsies are required, tell the patient that you will take biopsies of her cervix, which may cause some cramping.
11. Perform cervical biopsies and/or ECC as described in Practice Sheet 5.9.
12. If active bleeding is noted, pressure the bleeding area with a swab or apply Monsel's paste.
13. Withdraw the colposcope and gently close and remove the speculum.
14. Wait a few minutes and ask the patient to sit up slowly. Observe the patient for possible vasovagal symptoms (i.e. light-headedness, sweating, fainting). If they occur, have her lie down again and elevate her legs until she feels fine.



Biopsy and ECC

After the procedure

15. Explain what you saw and, if you took biopsies and/or endocervical curettings, what these may reveal.
16. Advise the patient how to take care of herself when she goes home:
 - She should abstain from sexual intercourse until she has no more discharge or bleeding (usually 2–4 days). Provide her with condoms and teach her how to use them, in case abstinence is not possible.
 - She should not insert anything into the vagina for 3–4 days.
 - Tell her the signs and symptoms of complications: active bleeding, serious cramping or lower abdominal pain, pus-like discharge and fever. If she experiences any of these, she needs to return to the health centre or go to the hospital.
17. Explain the importance of returning to the clinic for the results and give her a specific date for the return visit. Laboratory reports should be available within 2–3 weeks, so a follow-up visit should be planned 2–3 weeks after the colposcopy.

18. Document the findings. Use appropriate forms to record the colposcopic assessment.
19. Send labelled biopsies and curetted tissue to the laboratory.
20. If you noted something you cannot manage at your facility, refer the patient immediately to a higher-level facility for further examinations or tests.

Follow-up (2–3 weeks after the colposcopy)

21. Explain the results provided in the laboratory report.
22. Advise the patient what follow-up she needs, on the basis of the results. Use national guidelines or, if not available, the flowcharts in Annexes 8 and 9 and the chart in Annex 10 to advise the patient of her diagnosis and to establish a recommended treatment plan.
23. Do a pelvic examination and check for healing.
24. Refer the patient for needed therapy or make an appointment for the next visit.

Note: Your job is not done until you have reviewed the histopathological report with the patient and have a treatment plan in place.



Screen & treat strategies HIV–



Screen & treat strategies HIV+



Treatment by FIGO stage

Practice Sheet 5.9: Biopsy and endocervical curettage (ECC)

Biopsy

What is it and why is it needed?

Cervical biopsy is the removal of small pieces of cervical tissue with a special punch biopsy forceps (see Figure PS5.9.1) for the purpose of diagnosing abnormalities that were detected when the cervix was examined without magnification (e.g. during a pelvic examination for a cervical screening procedure) or abnormalities viewed with the aid of colposcopy. The biopsy samples are promptly placed in a labelled flask containing a liquid fixative – to preserve the tissues and their cellular structures just as they were when placed in the liquid – and then sent to a laboratory where very thin slices are stained with special stains and examined under a microscope in a process called histopathology.

If the tissue pieces are of sufficient size and well preserved, the results of histopathology will discriminate between cervical pre-cancer, invasive cancer and noncancerous lesions (e.g. warts [condyloma], herpes, infections, benign cysts or polyps).

Biopsy can be slightly painful or may cause cramps. Anaesthesia is usually not necessary. Bleeding is generally minimal and can be stopped by pressure with a cotton swab.

Figure PS5.9.1: Cervical punch biopsy forceps

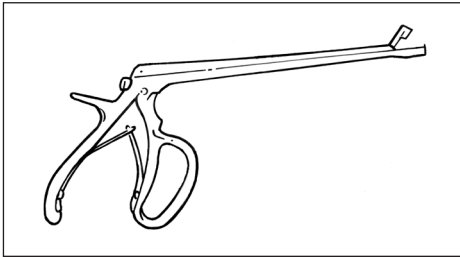

A biopsy should be performed by a trained health-care provider at a facility that has the necessary equipment and supplies.

Important note: When talking with the patient, the provider must not mention cancer, because until the results of the microscopic examination are received, the diagnosis is not known.

The following equipment and supplies are needed for biopsy:

- vaginal speculum – high-level disinfected
- colposcope (if needed to view the lesion)
- all necessary supplies for infection prevention
- 3–5% acetic acid
- Monsel's paste (see Annex 13)
- punch biopsy forceps
- cotton swabs
- specimen bottles with 10% formalin
- pencil and labels.

Preparation

1. Introduce yourself and explain the procedure, what the tests may show, and why it is important to return for the results and further management, if necessary.
2. Ensure that the patient has understood.
3. Obtain informed consent.
4. Show the patient the biopsy forceps and explain how it is used.
5. If being referred for the biopsy, tell her where she needs to go.
6. Tell the patient when the results are expected and where she should go to receive them, and discuss any further steps.
7. Ask her if you or another provider may contact her and establish what means can be used to contact her (e.g. telephone call, personal visit or delivery of a sealed note by a community worker) and if there are specific times when contact should not be attempted.

Procedure

8. Tell the patient that you will inform her of what you will do at every step, and warn her before you do anything that might cause cramps or pain. Prepare her for a pelvic examination (see Practice Sheet 5.2).
9. Insert a speculum and inspect the cervix for any obvious abnormalities.
10. After telling the patient that she might feel a mild stinging sensation, apply acetic acid and wait 1–2 minutes to allow colour changes to develop.
11. Observe any changes in the appearance of the cervix. Give special attention to abnormalities close to the squamocolumnar junction (SCJ).
12. Tell the patient that you will take a biopsy of her cervix, which may cause some cramping.



Pelvic exam

PS5

13. Take cervical biopsies of the most abnormal areas, and place tissues in separate labelled bottles containing formalin or other preservative solution.
14. If active bleeding is noted, apply pressure with a cotton swab for a couple of minutes; if bleeding continues, apply Monsel's paste to the bleeding areas (see Annex 13 for preparation of Monsel's paste) and gently remove the speculum.

Endocervical curettage

What is it and why is it needed?

Endocervical curettage (ECC) involves use of a special thin instrument to obtain tissue from the cervical canal for microscopic examination. It is used when:

- a cytology-based screening test is reported positive but no abnormalities are seen with a colposcope (see Practice Sheet 5.8) – there may be a pre-cancer or cancer hidden inside the canal;
- abnormal glandular cells are seen in the cytology-based screening test;
- colposcopy suggests abnormalities originating in the canal;
- the entire SCJ is not visible (colposcopy is reported as unsatisfactory).



Colposcopy

Important note: When talking with the patient, the provider must not mention cancer, because until the results of the microscopic examination are received, the diagnosis is not known.

The following equipment and supplies are needed for ECC:

- vaginal speculum – high-level disinfected
- all necessary supplies for infection prevention
- Monsel's paste (see Annex 13)
- endocervical curette
- cotton swabs
- specimen bottles with 10% formalin
- pencil and labels
- gauze or brown paper.

Preparation

1. Introduce yourself and inform the patient that you recommend ECC because you need to be sure there are no abnormalities inside the cervical canal.

2. Explain what the procedure involves, how long it takes and what she may feel (i.e. cramps and occasionally a fall in blood pressure, which may cause sweating, light-headedness and fainting).
3. Ensure that the patient has understood.
4. Obtain informed consent.
5. Show the patient the curette and explain how it is used.
6. If being referred for the ECC, tell her where she needs to go.
7. Tell the patient when the results are expected (this should be within 2–3 weeks) and where she should go to receive them, and discuss any further steps.
8. Ask her if you or another provider may contact her and establish what means can be used to contact her (e.g. telephone call, personal visit or delivery of a sealed note by a community worker) and if there are specific times when contact should not be attempted.

Procedure

9. Holding the curette like a pen, insert and scrape the endocervical canal in short, firm strokes, until it is completely sampled. Keep the curette inside the canal during the entire procedure.
10. At the end, remove the curette, place all used instruments in decontamination solution, and place the curettings on gauze or brown paper, and immediately immerse them in 10% formalin.

After the biopsy and/or ECC

1. Explain what you saw and, what the biopsies and/or endocervical curettings may reveal.
2. Advise the patient how to take care of herself when she goes home:
 - She should abstain from sexual intercourse until she has no more discharge or bleeding (usually 2–4 days). Provide her with condoms and teach her how to use them, in case abstinence is not possible.
 - She should not insert anything into the vagina for 3–4 days.
 - Tell her the signs and symptoms of complications: active bleeding, severe cramping or lower abdominal pain, pus-like discharge and fever. If she experiences any of these, she needs to return to the health centre or go to the hospital.
3. Explain the importance of returning to the clinic for the results and give her a specific date for the return visit. Laboratory reports should be available within 2–3 weeks, so the follow-up visit should be planned for 2–3 weeks after the procedure.

PS5

4. Document the findings on the appropriate forms.
5. Send labelled containers with biopsies and/or curetted tissue to the laboratory.
6. If you noted something you cannot manage at your facility, refer the patient immediately to a higher-level facility for further examinations or tests.

Note: Your job is not done until you have reviewed the histopathological report with the patient and have a treatment plan in place.

Practice Sheet 5.10: Treatment options for cervical pre-cancer: cryotherapy

Cryotherapy is the freezing of abnormal areas of the cervix by applying a highly cooled metal disc (cryoprobe) to them. It takes only a few minutes and usually only causes some cramping.

Table PS5.10.1: Eligibility and exclusion criteria for cryotherapy

Eligibility criteria (<i>all must be met</i>)	Exclusion criteria (<i>if any are met</i>)
<ul style="list-style-type: none"> • Positive screening test for cervical pre-cancer • Lesion small enough to be covered by the cryoprobe • Lesion and all edges fully visible with no extension into the endocervix or onto the vaginal wall 	<ul style="list-style-type: none"> • Evidence or suspicion of invasive disease or glandular dysplasia (pre-cancer) • Lesion extends beyond the cryoprobe edge • Pregnancy • Pelvic inflammatory disease (until treated) • Active menstruation

The following equipment and supplies are needed for cryotherapy:

- speculum, high-level disinfected (need not be sterile)
- disposable or high-level disinfected examination gloves (need not be sterile)
- cotton swabs for wiping the cervix
- normal saline solution
- colposcope, if used in the particular venue
- cryosurgery unit (see Figure PS5.10.1) with adequate gas supply (carbon dioxide or nitrous oxide).

Figure PS5.10.1: Cryotherapy equipment components

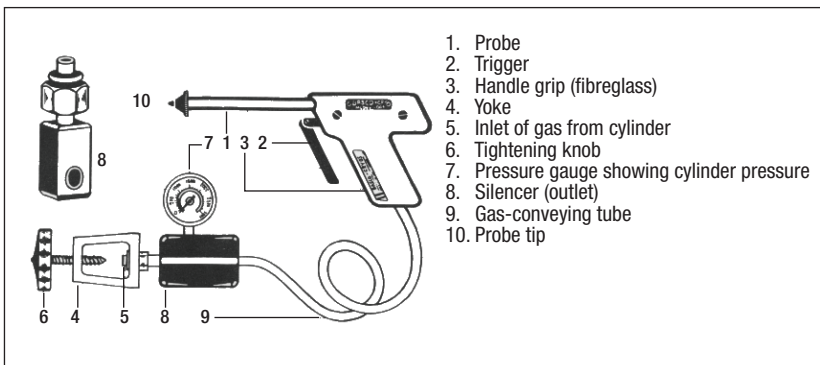

Source: Reproduced with permission from Sellors JW, Sankaranarayanan R. Colposcopy and treatment of cervical intraepithelial neoplasia: a beginners' manual. Lyon: International Agency for Research on Cancer; 2003 (<http://screening.iarc.fr/doc/Colposcopymanual.pdf>).

For basic equipment to perform a pelvic examination refer to Practice Sheet 5.2. For detailed WHO guidance on cryotherapy equipment please refer to *Cryosurgical equipment for the treatment of precancerous cervical lesions and prevention of cervical cancer: WHO technical specifications* (2012).¹⁸ For detailed WHO guidance on the use of cryotherapy, please refer to *WHO guidelines: use of cryotherapy for cervical intraepithelial neoplasia* (2011).¹⁹



Pelvic exam

Preparation

1. Explain the procedure, and why it is important to return for further management as requested.
2. Ensure that the patient has understood and obtain informed consent.
3. Show her the cryotherapy equipment and explain how you will use it to freeze the abnormal areas on the cervix.
4. Prepare the patient for a gynaecological examination, and perform a speculum examination.
5. If there is no evidence of infection, proceed with cryotherapy.
6. If there is a cervical infection, provide treatment (see Annex 12) and ask her to take the first dose while still with you. You may proceed with the cryotherapy, or you may give the patient an appointment to return once the infection is cured.



Treatment of infections

Procedure

7. Wipe the cervix with a saline-soaked cotton swab and wait a few minutes.
8. Apply acetic acid to outline the abnormality and wait a further few minutes to allow the white areas to fully develop.²⁰
9. Tell the patient she might feel some discomfort or cramping while you are freezing the cervix.
10. Wipe the cryoprobe surface with saline to ensure optimum effectiveness.
11. Apply the cryoprobe tip in the centre of the os and make sure the probe adequately covers the lesion. If the cryoprobe does not cover the entire lesion, do not proceed

¹⁸ Available at: <http://www.who.int/reproductivehealth/publications/cancers/9789241504560/en/index.html>

¹⁹ Available at: http://whqlibdoc.who.int/publications/2011/9789241502856_eng.pdf

²⁰ If white areas cover more than three quarters of the face of the cervix or they extend into the cervical canal, they are not eligible for cryosurgery. Remove the speculum and, after the patient is dressed, inform her why you did not do cryotherapy, and reassure her that this is not because she has cancer. Tell her the next best option is treatment with LEEP, summarize what this procedure is and help her make an appointment at the secondary-level hospital for this procedure.

with the freezing and explain the reason to the patient; please use instructions found in footnote 20 below, and counsel the patient on next steps.

12. If the cryoprobe covers a sufficient area of the cervix, before proceeding with freezing ensure that the vaginal wall is not in contact with the cryoprobe, as this may cause a freezing injury to the vagina.
13. Set the timer and release the gas trigger to cool the probe.
14. You will observe the ice forming on the tip of the cryoprobe and on the cervix (see Figure PS5.10.2). When the frozen area extends 4–5 mm beyond the edge of the cryoprobe, freezing is adequate.

Figure PS5.10.2: Position of cryoprobe on the cervix and ice forming

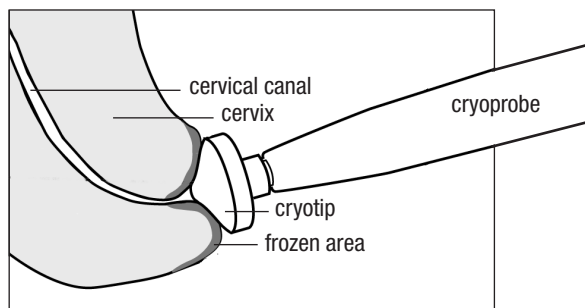

15. Allow two cycles of freezing and thawing: three minutes freezing, followed by five minutes thawing, followed by a further three minutes freezing.
16. Once the second freezing is complete, allow time for thawing before attempting to remove the probe from the cervix. Removing it before it is fully thawed will pull tissue off the cervix.
17. Gently rotate the probe on the cervix to remove it. The area you have frozen will appear white.
18. Examine the cervix for bleeding. If bleeding is noted, apply Monsel's paste (see Annex 13).
19. Do not pack the vagina.
20. Remove the speculum.

After the procedure

21. Provide a sanitary pad.
22. Instruct the patient to abstain from intercourse and not to use vaginal tampons for four weeks, until the discharge stops completely, to avoid infection.

PS5

23. Provide her with condoms and teach her how to use them, if she cannot abstain from intercourse as instructed.
24. Inform her of possible complications and ask her to return immediately if she has:
- fever with temperature higher than 38°C or shaking chills
 - severe lower abdominal pain
 - foul-smelling or pus-like discharge
 - bleeding for more than two days or bleeding with clots.
25. Ask her to return in 12 months for a repeat cervical screening test, or sooner if she needs to.

Processing the used equipment (after the patient has left)

Clean and disinfect the cryoprobe and decontaminate the cryogun, tubing, pressure gauge and gas tank as follows:²¹

1. Decontaminate the cryotherapy unit, hose and regulator by wiping them with alcohol.
2. Wash the cryotip and the plastic sleeve with soap and water until visibly clean.
3. Rinse the cryotip and plastic sleeve thoroughly with clean water.
4. High-level disinfect the cryotip and plastic sleeve by one of the following methods:
 - boil in water for 20 minutes; or
 - steam for 20 minutes; or
 - soak in chemical disinfectant (0.1% chlorine solution or 2–4% glutaral) for 20 minutes and then rinse with boiled water.
5. It is critical that the hollow part of the cryotip is completely dry when next used, otherwise the water will freeze and the probe could crack or the treatment may not work.
6. Either use a rubber cap to seal off the hollow part of the cryoprobe during processing, or thoroughly dry the cryoprobe before it is reused.
7. If none of the high-level disinfection options are available, the cryotip and sleeve may be disinfected by soaking in 70–90% ethanol or isopropanol for 20 minutes. Allow to air-dry and then reassemble.

²¹ Some cryoguns get blocked by ice. This can be avoided by pushing the defrost button every 20 seconds to clean the tube.

Practice Sheet 5.11: Treatment options for cervical pre-cancer: loop electro-surgical excision procedure (LEEP)

LEEP is the removal of abnormal areas from the cervix, using a loop made of thin wire heated with electricity. It is successful in curing pre-cancer in 9 out of 10 women.

The following equipment and supplies are needed for LEEP:

- reliable power supply
- electro-surgical generator and electrode handle
- colposcope
- non-conducting speculum, preferably with side retractors
- return electrode
- wire electrodes of several sizes (see Figure PS5.11.1)
- coagulating/ball electrode
- smoke evacuator
- forceps
- local anaesthetic: 1% or 2% lidocaine, with or without 1:100 000 epinephrine
- 5-ml syringes with long 27-gauge needles
- bottles with normal saline and with 5% acetic acid
- Monsel's paste (see Annex 13)
- large swabs
- needles and suture material
- specimen containers with 10% formalin.

Figure PS5.11.1: Different types and sizes of electrodes

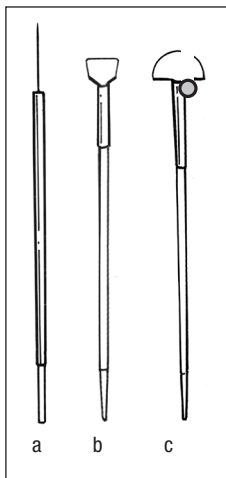

- (a) ball electrode
- (b) square loop electrode
- (c) semicircular loop electrode

For basic equipment to perform a pelvic examination refer to Practice Sheet 5.2.



Pelvic exam

Preparation

1. Explain the procedure and why it is important to return for further management as requested. Ensure that the woman has understood and obtain informed consent.
2. Prepare the patient for a pelvic examination (see Practice Sheet 5.2).
3. Attach a return electrode to the inner thigh.
4. Insert a non-conducting speculum with an electrically insulating coating, or a speculum covered with a latex condom.
5. Look at the cervix, and note any abnormalities, such as discharge from the os, inflammation, bleeding or lesions. Record the findings.
6. If there is no evidence of infection, proceed with LEEP. If you note signs of infection, suspend the procedure and treat the patient and her partner completely (see Annex 12) before making a second attempt.



Treatment of infections

Procedure

7. Before each step, tell the woman what you will do and what she may feel.
8. Wipe the cervix with a saline-soaked cotton swab.
9. Apply 5% acetic acid and examine with the colposcope to determine the location and extent of the lesion.
10. Inject 3–5 ml of local anaesthetic (1% or 2% lidocaine with 1:100 000 epinephrine to control bleeding), using a long 27-gauge needle, just beneath the cervical epithelium at the 12 o'clock, 3 o'clock, 6 o'clock and 9 o'clock positions (in patients with cardiac problems, use lidocaine without epinephrine).
11. Select the appropriate electrode to enable removal of the entire abnormal area in a single pass: for small, low-grade lesions in nulliparous women, use an electrode 1.5 cm wide by 0.5 cm deep; for larger lesions and multiparous women, use an electrode 2.0 cm wide by 0.8 cm deep.
12. Turn the vacuum suction on and activate the generator.
13. Excise the lesion: push the electrode perpendicularly into the tissue to a depth of 4–5 mm and draw it laterally across the cervix to the other side, producing a dome-shaped circle of tissue with the canal in the centre (see Figure PS5.11.2). DO NOT insert the electrode deeper than 5 mm at the 3 o'clock and 9 o'clock positions, because this could damage the cervical branches of the uterine artery.

Note: In some cases, the patient may have a vasovagal reaction, with fainting and plummeting blood pressure. If this happens, stop the treatment immediately and raise the patient's legs as much as possible.

Figure PS5.11.2: LEEP of an ectocervical lesion with one pass: excision of the lesion with wire electrode and coagulation with ball electrode

14. Additional passes with the loop can be made to excise residual tissue.
15. Pick up all excised tissue with the forceps, and place in a labelled bottle with formalin to send to the histopathology laboratory.

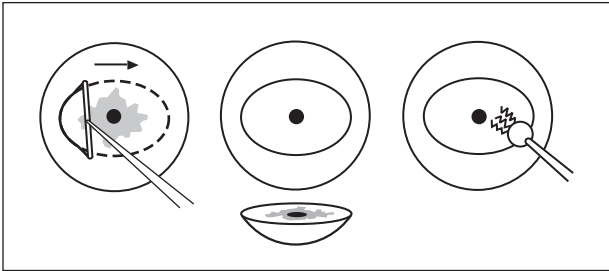

16. Perform an endocervical curettage (ECC) and place the tissue in a separate bottle with formalin (see Practice Sheet 5.9).
17. Coagulate any bleeding tissue in the crater base using a ball electrode and coagulation current.
18. Apply Monsel's paste to the crater base to prevent further bleeding and remove the speculum.



Biopsy and ECC

After the procedure

19. Provide a sanitary pad.
20. Instruct the patient to abstain from sexual intercourse for a minimum of four weeks, and until the bleeding stops completely. This is to avoid infection and heavy bleeding.
21. Provide condoms and teach her how to use them, if she cannot abstain from intercourse as instructed.
22. Tell her she may have some mild to moderate pain for a couple of days; she can take ibuprofen or paracetamol.
23. Explain that she may have very light bleeding and that she will notice blood-tinged discharge for a month or more. She can use sanitary pads but not tampons for this.
24. Advise the patient how to take care of herself when she goes home:
 - She should rest and avoid heavy work for several days.
 - She should not put anything in the vagina.

PS5

25. Inform her of possible complications and ask her to return immediately if she has:
- fever with temperature higher than 38°C or shaking chills
 - severe lower abdominal pain
 - foul-smelling or pus-like discharge
 - heavy bleeding or bleeding with clots.
26. Answer her questions.
27. Recommend that she should return to the health centre in 2–6 weeks to be checked for healing and to receive the report of the laboratory results.
28. Agree a follow-up date with her.

Follow-up visit (2–6 weeks post-procedure)

29. Ask how the patient is feeling and if she has had any unexpected problems since the LEEP.
30. Review the pathology report with the patient and advise her on the recommended next steps.
31. Examine the patient to check healing.
32. Ask her to return for repeat cervical screening 12 months after the LEEP. Follow up as described in the flowcharts in Annexes 8 and 9.



Screen & treat
strategies HIV–



Screen & treat
strategies HIV+

Management of complications of LEEP**Table PS5.11.1: Management of possible complications of LEEP**

Problem	Treatment
Bleeding during the procedure: can be diffuse or arterial	<p>For diffuse bleeding: use a combination of pressure and coagulation with ball electrode.</p> <p>For arterial bleeding: place ball electrode in firm contact with the source and use coagulation current.</p>
Bleeding after the procedure (this happens in less than 2% of cases)	<p>Remove blood clot, clean with 5% acetic acid, identify bleeding area, anaesthetize with lidocaine and epinephrine.</p> <p>If bleeding is not heavy, apply Monsel's paste. If bleeding is heavy, coagulate using either a 5-mm ball electrode or a macroneedle electrode and the coagulation current.</p>
Infection after the procedure: pus-like discharge, pain, fever	<p>Treat with antibiotics according to national protocols.</p> <p>For example:</p> <ul style="list-style-type: none"> • cefixime 400 mg, orally, single dose, plus • doxycycline 100 mg orally twice daily for 14 days, plus • metronidazole 400–500 mg, orally, twice daily for 14 days.

Practice Sheet 5.12: Treatment options for cervical pre-cancer: cold knife conization (CKC)

Cold knife conization (CKC) is the removal of a cone-shaped area from the cervix, including portions of the outer cervix (ectocervix) and inner cervix (endocervix). The amount of tissue removed will depend on the size of the lesion and the likelihood of finding invasive cancer. The tissue removed is sent to the pathology laboratory for histological diagnosis and analysis to ensure that the abnormal tissue has been completely removed. A CKC is usually done in a hospital.

Explaining the procedure

Give the woman as much advance information as you can on the procedure, the anaesthesia, and the possible side-effects and complications. The description below will help you answer any questions she may have about the procedure she will undergo at the hospital.

Preparation

1. The hospital staff will give the patient details on the procedure, start time, duration, possible side-effects and complications and how to take care of herself when she returns home.
2. The hospital staff will also give her instructions on how she should prepare before arriving for the surgery (i.e. what clothing to bring and any medicines she should take beforehand). She will be told not to eat or drink anything in the eight hours before surgery, and to bathe before coming to the hospital.
3. When her questions have been answered, the patient will be asked to sign an informed consent, which is required by the hospital.

The operation

4. General or spinal anaesthesia will be administered so that the patient will not feel anything during the operation.
5. The surgeon will insert a speculum into her vagina to visualize the cervix.
6. An iodine solution will be applied to highlight the abnormal areas, and the cervix will be examined.
7. A substance to reduce the risk of heavy bleeding will be injected into the cervix, or the surgeon may suture the small arteries supplying the area that will be removed.
8. A cone-shaped area of the cervix, including the endocervical canal, will be removed using a special knife (see Figure PS5.12.1). The removed tissue will be placed in a jar with formalin and sent to the laboratory. Often, a stitch is placed into the cone specimen to mark orientation of the specimen for pathology; the location of this stitch should be recorded on the appropriate histology form (e.g. stitch at 12 o'clock).

Figure PS5.12.1: Removal of cone-shaped area of the cervix

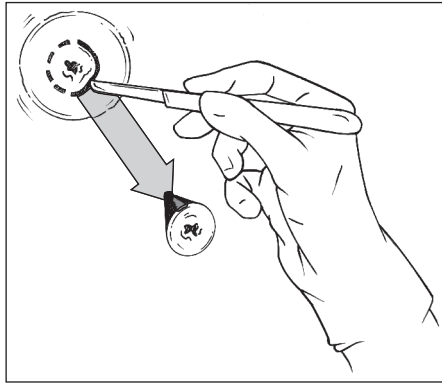

9. After the cone is removed, the base of the crater (the area of the cervix after excision) will be cauterized using ball cautery.
10. Any active bleeding will be stemmed by applying pressure using cotton balls and by applying Monsel's paste (see Annex 13), or by using ball cautery.
11. A gauze pack may be placed in the vagina to apply pressure and control the bleeding, but this will not be done if Monsel's paste has been used.



Monsel's paste

Just after the operation

12. The patient will be monitored by the hospital staff in the recovery room. Once she wakes up, she will be moved to a regular bed to recover fully.
13. If she feels well, has no significant bleeding, and lives near the hospital, she will be discharged after a few hours. If she is not able to go home the same day, she will be discharged the next day, provided there are no complications.
14. Before she leaves the hospital, the patient will be told that she has a hidden wound on the cervix, which needs at least 4–6 weeks to heal.
15. To prevent infection and allow proper healing of the raw area of the cervix, she will be told that she should not put anything into the vagina for the next six weeks, including fingers or tampons, and she should not douche or have sexual intercourse. If she is unable to abstain from intercourse for six weeks, provide condoms and teach her (and her partner) how to use them.
16. She will be given counselling on how to take care of herself, and information on what symptoms or complications to look out for (see Table PS5.12.1), with instructions to go to the health centre or hospital immediately if any of them occur.
17. She will be given an appointment for her first follow-up visit 2–6 weeks after the CKC.

Management of possible complications of CKC**Table PS5.12.1: Management of possible complications of CKC**

Complication	Symptoms	Treatment
Infection	Pain in the lower abdomen Foul-smelling yellow discharge from vagina	<ul style="list-style-type: none"> • Provide treatment for PID
Haemorrhage	Heavy vaginal bleeding	<ul style="list-style-type: none"> • Speculum examination, remove blood clot, identify bleeding areas • Coagulate/cauterize bleeding area using ball electrode • Apply Monsel's paste or pack with ribbon gauze

Follow-up care at home

These instructions are for the provider who will provide home-based care:

18. Before the patient leaves the hospital after CKC, she will be given counselling on how to take care of herself to aid healing, and what symptoms or complications to look out for (see items 15 and 16 in the previous list). You can help her by reinforcing this advice and repeating it if necessary.
19. If gauze packing was left in the vagina, it must be removed within 6–12 hours to avoid infection. You (or another local health-care provider who knows how) can assist with this.
20. Relative rest for a few days is recommended. The patient should avoid heavy work for the first three weeks. Normal daily activities can be performed, such as light housework, bathing, showering and eating.
21. If the patient has discomfort (not severe pain), she may take paracetamol.
22. The patient should have been given a follow-up appointment 2–6 weeks after the operation to discuss the laboratory results of the tissue examination and to be examined by the surgeon. Encourage her to keep this appointment.

Follow-up visit (2–6 weeks post-procedure)

23. Ask the patient how she is feeling and if she has had any unexpected problems since the CKC.
24. Review the pathology report with the patient and advise her on the recommended next steps.
25. Examine the patient to check healing.
26. Ask her to return for repeat cervical screening 12 months after the CKC. Follow up as described in the flowcharts in Annexes 8 and 9.



Screen & treat strategies HIV–



Screen & treat strategies HIV+

Chapter 6 Practice Sheets

These practice sheets are intended to assist primary- and secondary-level health-care providers when they meet with patients who have symptoms that may be due to cervical cancer or patients who have been diagnosed with cervical cancer. The information here should allow these providers to answer questions about the tests and treatments that will take place at the hospital, fill in any gaps in understanding that the patient or her family may have, and provide other needed support before or when the patient is admitted for care.

Only Practice Sheet 6.4 is aimed at tertiary-level health-care providers, to provide suggestions for talking with cervical cancer patients before and after staging tests and when cancer treatment is discontinued.

Practice Sheet 6.1: When a patient consults you because she has symptoms that may be due to cervical cancer

Important note: Cervical cancer can only be diagnosed by microscopic examination of tissue removed from a lesion.

If a woman presents to a primary- or secondary-level provider with one or more of the symptoms listed in this practice sheet, cervical cancer should come to mind as a possible cause. However, all the listed symptoms can be due to many causes other than cervical cancer. It's very important that if a woman complains of one or more of the symptoms in the list, you do not immediately mention cervical cancer; this may frighten her unnecessarily. Rather, you should explain to her that she needs to have an examination and possibly some tests to find out what is causing the symptoms so that appropriate treatment can be provided.

Symptoms of early invasive cervical cancer may include:

- vaginal discharge not resolved by common treatments, sometimes foul-smelling
- irregular bleeding in women aged in their mid-30s and above
- bleeding after intercourse in women of any age.

Symptoms of more advanced cancer can include all of the above, plus:

- urinary frequency and urgency or decreased urination
- leakage of urine or faeces from her vagina
- severe backache and lower abdominal pain
- severe swelling of one or both legs and feet.

A primary-level provider, who may not have the right training or may be lacking the equipment to perform a complete pelvic examination, should refer the patient to a gynaecologist at the secondary-level hospital.

If you have been trained and have the necessary equipment and supplies, you may do a pelvic examination on a woman who has one or more of the symptoms listed (see Practice Sheet 5.2 for full details on performing a pelvic exam). If you notice any growth or ulceration on the face of the cervix, a biopsy needs to be performed and sent to the laboratory to be examined microscopically in order to make a definitive diagnosis.

While you examine the patient, remember to converse with her and explain what you are doing at every step and what you are noticing.

If you are able to do a biopsy, we highly recommend that you first reread Practice Sheet 5.9 for details on how to perform a biopsy and follow the steps provided there.



If your laboratory cannot provide biopsy results within 2–3 weeks, it is preferable to send the woman to see a gynaecologist at the nearest facility with a laboratory that can do so.

If the biopsy shows invasive cervical cancer, the patient needs to be informed and referred to a tertiary care facility. See Practice Sheet 6.2 for suggestions on how to have this difficult conversation.



Counselling:
Cancer diagnosis

Remember: With cervical cancer, early detection is the key to curative treatment. Providers must pay attention to symptoms in women over the age of 35 that may indicate cervical cancer and make sure they are promptly examined and tested.

PS6

Practice Sheet 6.2: Informing a patient about a diagnosis of cervical cancer, and talking about it with the patient and her support circle

To the provider: Please read and give some thought to the contents of this practice sheet BEFORE meeting with a woman who has been diagnosed with invasive cervical cancer and her support circle. It will assist you in preparing for this difficult task.

Always be mindful of cultural aspects of the patient's family and community during conversations about cervical cancer and other potentially fatal diseases.

Be aware that reactions of denial, anger and resignation are common after receiving a diagnosis of cancer. It's important for the patient to know that you are available to continue the conversation, explore her feelings and reactions and help her find peace with the findings and proposed treatments.

Preparation

- Respect the culture, norms and customs of the patient and her community; it may or may not be acceptable, for example, to give difficult news directly to the patient. It is, however, important that she understands what is going on so that she can participate in decision-making regarding her health care.
- To give information to a woman and her family about cervical cancer, it is important to be away from other people in a more private space that will allow the woman and her family the freedom to ask questions. Ensure that such a space is available.
- A diagnosis of cancer is often unexpected; providing the most accurate information about her disease allows the patient and her family to begin to understand the diagnosis and think about the treatment. Ensure that you have all the necessary information.
- Think about what personal information would be useful for you to know about the patient, and how you can obtain it during the conversation. For example, will she need assistance in obtaining access to the tertiary care facility? She may face issues such as lack of financial resources or transportation, difficulty getting time off work or finding alternate caregivers for children, or elderly or sick people who may be in her care. If so, you may be able to mobilize her family and friends as well as community-based helpers to provide assistance.

Talking with the patient (and her family if she wishes to include them)

- Always remember that one of the most powerful therapeutic tools is your ability to listen to your patient and to understand her perspective.
- Ask for permission to discuss the situation before speaking.
- Be clear and direct when you explain the diagnosis; use words that are understood in the language of everyday use. Do not use words that are technical, that the patient will not understand, or that are vague, such as “growth” or “neoplasm”.
- Allow some time for those present to take in the impact of what you have said, then give them time to ask questions.
- Remember to inform them that all women can be treated for cervical cancer: many will be cured with treatment, and others will have their quality of life improved by treatment.
- As people are often shocked when they receive unexpected bad news, they may not fully hear or understand what has been said. Sometimes it helps to show or draw pictures and/or give them simple information in writing, to help them remember what was discussed, which may prompt them to think of additional questions they might have. You may need speak with them over a period of a few days to allow new information and thoughts to be absorbed, and new questions to emerge.

Additional topics to explore

- If the patient will consider accepting conventional treatment, discuss whether she also intends to use the help of traditional healers.
- It is important to be nonjudgemental and allow the patient to express her beliefs; help her understand that different systems of health care can work together in a complementary manner to ensure the best possible outcome for her.
- Explore what the patient understands about cancer, how she interprets the cancer diagnosis, what her fears and expectations are, and what she knows about available treatments.
- Be ready to explain that cervical cancer will progress and ultimately cause death if left untreated.
- Explore what psychosocial/emotional, economic and spiritual support the patient and her family can mobilize, as this can be very important. If her support network is inadequate, consider what other support will be needed.

Note: It may be necessary to have these conversations in more than one session.

PS6

Practice Sheet 6.3: Providing advance information to patients with cervical cancer about what may take place at the hospital

After making an appointment for the patient to be seen at the hospital, explain what she can expect once she is there.

Tell the patient that she will be seen by a specialist at the hospital who will give her details of what tests she may need to help determine the best treatment for her. She can have most tests and treatments at the hospital on an outpatient basis. But if it is too far for her to go to the hospital and come back home every day, she and her family need to be aware that she may need to find a room near the hospital where she can stay during the tests and/or treatment.

At the hospital:

- The patient will have a complete physical exam and several tests to determine the extent of the cancer. These tests may include blood and urine tests, tests to determine if the cancer has spread to the rectum (proctoscopy) or the urinary system (cystoscopy), as well as a CT or MRI scan to find out if the cancer is also elsewhere in her body.
- Once the results are available, the specialists will talk with the patient and describe the best available option or options for treatment, including information about how long each treatment takes, how she will feel, side-effects that may occur, and the cost of the treatments, if applicable.
- The specialists will ask the patient when she thinks she can arrange her personal affairs and be ready to be admitted for any procedures or treatments that need to be provided on an inpatient basis.
- When the patient is admitted, the specialists will again describe the treatment plan and will explain about the informed consent the hospital requires; she will be asked to read it and sign the consent form after all her questions have been answered.
- It is important that she understands that, even after she signs the informed consent form, she is free to change her mind (i.e. she is not obligated to go ahead with any proposed test, procedure or treatment).

Practice Sheet 6.4: Talking to a patient about her cancer and treatment: suggestions for tertiary-level health-care providers (cancer specialists)

PS 6

Meeting with the patient before staging tests are conducted

- When first meeting, introduce yourself and inform the patient of your role in her care.
- Reassure her that you and your team will do your utmost to provide the best available treatment with the goal of curing her cancer or, at the very least, reducing her suffering and extending as well as improving her life once she is discharged.
- Encourage the patient and her family to keep her health-care providers informed of any changes she notices and any side-effects she may experience once treatment begins.
- Using clear and non-technical language, discuss all tests that are presently planned to determine the extent or stage of her cancer, and explain that this information is needed to help choose the treatment that should provide the best outcome. Tell her you will keep her informed in advance of any new procedure planned and that you will be able to answer all her questions.

Meeting with the patient to discuss treatment after her cancer stage has been determined

- Explain the test results including the findings about the degree of spread of the cancer and its severity, and provide the patient with an overview of available treatments for her cancer stage.
- At this point, the patient and her companions will probably have many questions about the suggested treatments, her probable life expectancy and what would happen if she refused the recommended treatment. Take the time necessary to respond to questions and discuss all these issues with them.
- In discussing the best available treatment or treatments recommended for the patient's cancer and stage, be sure to cover the following:
 - What is/are the suggested treatment(s)?
 - Where/how will they be provided (e.g. at hospital on an in- or outpatient basis)?
 - How much time will be needed for treatment completion?
 - What are the common side-effects?
 - What will the patient's out-of-pocket costs be?
 - What are the possible outcomes if she decides not to have the treatment(s)?

PS6

- Regarding the patient's prognosis, it is important to be truthful but optimistic in describing the best-case outcomes. Based on the stage of her cancer, provide her with information regarding the usual outcomes in other patients with similar cancers to hers. Please also be sure to inform her that there is a range of outcomes and that you cannot be absolutely sure which course she will follow. If treatment is expected to cure her disease, tell her this, but always leave room for the possibility that this may not be the case.
- If she has extensive cancer that is probably not curable, inform the patient and her family that treatment, despite a variable amount of side-effects, can alleviate some of her symptoms and make her more comfortable. Give her an approximate life expectancy in months and/or years based on the prognosis in other similar cases, and be sure to explain that this is only an educated guess, not a certainty.
- Please remember that the most useful therapeutic tool is the ability to listen. Stop periodically to ask and respond to questions.

How to have a conversation with a patient whose cancer treatment is discontinued because it has not had any beneficial effect on her health or cancer status

- When it becomes obvious that no further cancer treatment will be of benefit to the patient, it is best to counsel the patient and family in a sensitive but truthful manner. It would be best if this conversation took place in the context of an ongoing provider–patient relationship, rather than being initiated by someone the woman has never met before. The provider needs to be as calm and supportive as possible; this is a very emotional and saddening conversation.
- Always be mindful of cultural aspects of the patient's community that may be relevant to conversations about impending death.
- Ensure that you are in a space that has auditory and visual privacy and tell those present that this is a confidential conversation.
- The provider can first enquire about how the patient is feeling, what symptoms are present, and which people at home and in her community can help with her physical, emotional and spiritual needs.
- Review with the patient what has been done in the past few weeks to care for her health and very carefully approach the topic that no improvement has been achieved in the last X number of weeks or months. Explain that for this reason, the doctors caring for her have decided that further treatment directed at the cancer would not benefit her.

- It is also very important to let patients know that even though cancer treatment did not help to reduce the worsening of her disease and its symptoms, you are still committed to her comfort and to treating her symptoms, including pain. Don't forget to talk with her about the fact that she will be with her family and close support circle.
- Try not to say “nothing more can be done”, because caregivers CAN do a lot to help: relieving symptoms, supplying medication, arranging lower-level care, or just being available. Questions about how much time is left should be answered honestly, i.e. that you do not know but it may be a question of a few days/weeks/months, as appropriate for her situation. This will give an indication to the patient and family of what to expect, so that they can make appropriate arrangements.
- Before finishing this conversation, please make sure the patient is reassured that she will receive the necessary follow-up, that she knows who to see when and where, and express your willingness to be supportive in any way possible.

Practice Sheet 6.5: Treatments for cervical cancer: hysterectomy

Hysterectomy is the removal of the uterus. In simple hysterectomy, the entire uterus, including the cervix is removed. The tubes and ovaries may or may not be removed. In radical hysterectomy, the uterus plus tissues around it and part of the upper vagina are removed. The procedures are essentially identical, as described here.

This practice sheet is included to allow a primary- or secondary-level health-care provider to explain to a patient, before she goes to hospital, how the surgical procedure will be performed, and to help her recover once she returns home.

Explaining the hospital procedures

Give the patient basic information on the procedure. The description below will help you.

Before the patient is admitted to hospital

1. The hospital staff will give her instructions on how she should prepare before arriving for the surgery (i.e. what clothing to bring and any medicines she should take beforehand). She will be told not to eat or drink anything in the eight hours before surgery, and to bathe before coming to the hospital.

In the hospital: preparation

2. The details of the operation will be explained (i.e. start time, duration, possible side-effects and complications) as well as the need for the patient to sign the informed consent, which is required by the hospital, when her questions have been answered. You need to reiterate that after signing, she will still have the option to change her mind up to the last minute.
3. To help prevent infection, the woman's genital and abdominal areas will be cleaned with soap, water and iodine; her pubic hair may be clipped.
4. General anaesthesia will be given intravenously or by inhalation.
5. A plastic tube (catheter) will be placed into her bladder and her urine will be collected in a bag until the bladder has recovered from the operation.

The operation

6. A cut will be made in the lower abdomen.
7. In simple hysterectomy, the uterus is cut away from where it is attached to the fallopian tubes and the vagina. In radical hysterectomy, the surgeon removes the uterus, the tissues surrounding it, and the cervix with a short portion of the upper vagina, in addition to some lymph nodes, in order to check whether they are involved with the cervical cancer.
8. All the tissues removed will be placed in a preservative solution and sent to the laboratory, where a pathologist will examine them to determine if the entire cancer has been removed.
9. At the end of the operation, a drain may be left in the pelvis; this is a plastic tube placed in the abdomen to drain blood and fluid into a bag. It may be left in place for 24–48 hours.
10. Most surgeons will also put a tube (known as a suprapubic catheter) from the outside of the abdomen into the bladder, to drain urine. It will be left in place for 5–7 days to allow the bladder to recover.
11. The abdomen will then be sewn closed and wiped clean, and the wound bandaged.

Just after the operation

12. After the operation, the patient will be cared for by hospital staff in a special recovery room. Once she wakes up, she will be moved to a regular bed to recover.
13. When the patient wakes up, she may note that she has an intravenous tube attached to a bag containing a clear solution, which will be dripping into one of her arm veins.
14. Very often, a patient will feel nausea lasting no more than a few hours, for which she can be treated. For the first few days, if needed, she will also receive medicines to relieve pain in her lower abdomen.

Recovery in the hospital

15. To help prevent complications, the staff will make sure that the patient coughs from time to time and breathes deeply to keep her airways clear of mucus, and that she sits up, moves her muscles and walks as soon as she is able.
16. The movement of tissues and organs in the pelvis during the operation may cause the nerves around the bladder and rectum to become “lazy”, and passing urine and stool will be difficult. The bladder catheter will be left in place for 5–7 days until the patient can urinate normally. In most cases she will be able to urinate and pass stool on her own, although perhaps with some difficulty and assistance from medicines that will be provided during her recovery at home. These functions should return completely to normal within 3–4 months.

PS6

Recovering at home

Most hospitals will allow the patient to return home 7–10 days after a hysterectomy, depending on how fast she recovers initially and what care is available at home. Complete recovery from a radical hysterectomy takes 6–12 weeks.

1. Before she leaves hospital, the patient will be given counselling on how she can take care of herself at home and how her family can assist, including what symptoms or complications to look out for. You, the primary- or secondary-level health-care provider, can help by reinforcing this advice.
2. Supplies she will need at home can be obtained from the hospital or by using a prescription written for later, if needed. These include:
 - paracetamol for mild pain (if needed)
 - stool softener (e.g. bisacodyl)
 - urinary catheters
 - gauze bandage and disinfectant for the wound.
3. To help the patient recover from the operation, other members of the family should take over her normal household tasks for the first six weeks and gradually encourage her to do more of these, starting with those requiring the least effort, until she regains her strength. She and her family will be advised that she should avoid doing heavy housework, walking long distances, carrying heavy objects, or performing other physically taxing tasks. In the first few days at home, she should be able to bathe/shower, eat and do light walking. After a few days, she should start to increase her walking (e.g. two short walks a day), but still avoid any heavy lifting. The family should encourage the patient to rest when she seems tired, and make sure she eats well.
4. The patient will have a hidden wound in the vagina that needs at least six weeks to heal. To prevent infection and allow proper healing, she should not put anything into the vagina for that time, including fingers or tampons, and she should not use vaginal douching or have sexual intercourse for those first six weeks. Her partner's support in this will be important.
5. Make sure that the patient and her family know about the common symptoms that may occur in the few weeks after surgery, and what the patient should do if they occur (see Table PS6.5.1).

Table PS6.5.1: Common symptoms that may occur after a hysterectomy – what the patient can do

Symptom	Cause	What to do
Depression	Pain, fatigue, worry	Wait. Feeling sad after a major operation is common. This should not last more than 2 weeks or so.
Abdominal discomfort	Soreness from the cutting that was done	This is normal. The patient should eat food high in fibre, drink plenty of liquids, take stool softeners (bisacodyl); this should disappear within 6 months.
Difficult and slow urination; bladder not emptying properly	Nerve damage during surgery, “lazy” bladder	“Double void”: pass urine normally then get up, walk around for a few minutes and pass urine again. If this does not work, she may have to put a tube in herself. The hospital will show her how to do this and give her the materials. The problem should disappear within 3–6 months.
Tiredness	The body is healing itself and needs extra rest	This is normal. She should lie down to rest during the day as often as she needs.

6. Make sure that the patient and her family know the signs and symptoms of complications that may occur after hysterectomy and instruct her to go to the health centre or hospital if any of them occur (see Table PS6.5.2).

Table PS6.5.2: Complications that may occur after hysterectomy – how to recognize them

Complication	Signs and symptoms*
Infection of the abdominal wound	<ul style="list-style-type: none"> • Pain, redness and pus in the cut area on the abdomen
Infection in the pelvis	<ul style="list-style-type: none"> • Pain (not just discomfort) in lower abdomen, often with fever • Foul-smelling vaginal discharge or bleeding
Lymphocyst – caused by collection of lymph fluid after removal of lymph glands	<ul style="list-style-type: none"> • Swelling or pain in the lower abdomen 2–3 months after surgery
Bladder infection	<ul style="list-style-type: none"> • Burning sensation on urination • Frequent urination
Blood clot in the leg (thrombosis)	<ul style="list-style-type: none"> • Redness, pain and swelling in one leg

*If the patient develops any of these signs and symptoms, she should consult her provider.

PS6

Follow-up care (six weeks after surgery)

The patient is likely to choose to go to the secondary-level hospital and see a gynaecologist there, due to the additional distance, time and costs that may make it difficult for her to return to the tertiary-level hospital where she underwent the surgery.

1. The gynaecologist will explain the results of the microscopic examination of the tissue removed during the surgery, and examine the patient thoroughly to make sure that she is recovering normally. Any problems detected will be managed.
2. She will be examined with a speculum to make sure the wound in the vagina has healed.
3. The information from the laboratory and the speculum examination will allow the gynaecologist to discuss with the patient how far the cancer had spread, what other treatment might be needed and the chances of the cancer returning.
4. If the gynaecologist considers that the recovery is not progressing normally and he or she cannot manage the problems that have been noted, the patient will be urged to return to the specialist(s) at the tertiary-level hospital. You, the primary- or secondary-level health-care provider, may need to help the patient find the means for this.
5. The gynaecologist should inform the patient that he or she will communicate directly with the specialists, if possible, to report his or her findings and to continue oversight of the patient's case from a distance.

Practice Sheet 6.6: Treatments for cervical cancer: pelvic teletherapy

PS 6

Pelvic teletherapy is a type of radiotherapy given to the pelvic area from a distance (external radiation), using a special machine.

This practice sheet is included to allow a primary- or secondary-level health-care provider to explain to a patient, before she goes to hospital, how the procedure will be performed, and to help her recover once she returns home.

Explaining the teletherapy procedures

1. Introduce yourself and talk with the patient about the reason she is having treatments.
2. Explain the prescribed teletherapy treatments, what the procedure will consist of (see the description in the remainder of this practice sheet).
3. Inform the patient that special examinations may be done before the therapy is started, to map the area of her lower abdomen where the radiation will be focused.
4. Tell her that, during treatment, she will be lying on a flat couch that is part of a machine. You may show the patient Figure PS6.6.1, which shows the kind of equipment used for teletherapy.
5. Explain that a computer or other mapping technique is used to plan the treatment in order to maximize the effect on the tumour and minimize the effects on normal (non-cancerous) tissues or organs.
6. Inform her that the radiation will be beamed from the machine head above her, focused on the pelvic area where the cancer is found.
7. Give the woman information about the possible side-effects (see Table PS6.6.1), and emphasize that it will be important for her to let someone know if she is having symptoms during the course of the therapy sessions, as these side-effects can be treated.

PS6

Figure PS6.6.1: Machine for teletherapy

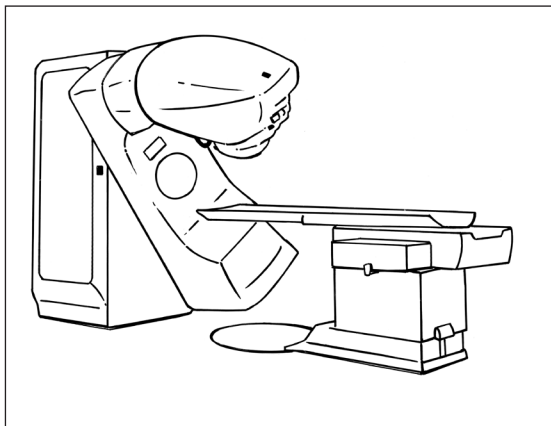

8. Explain that treatments will take place in daily sessions of a few minutes each for 5–6 weeks. Reassure her that she will not feel anything during treatment and anaesthesia is not required.
9. Tell her that at the hospital they will give her more details about the treatment, and inform her of who will be in charge of her treatment at the hospital.

The description provided here will help you to explain the prescribed teletherapy treatments and procedures to the patient.

Preparation: in the days before the therapy starts

1. The hospital staff will give the patient instructions on how she should prepare before arriving for the therapy (i.e. what clothing to bring and any medicines she should take beforehand).
2. The details of the treatment, possible complications and options will be explained and informed consent requested.
3. The patient will be given an appointment for planning of the treatment sessions.
4. When she attends that appointment, she will be asked to undress and to lie on a special table. She may have a pelvic examination and X-rays will be taken. With the information obtained from the X-rays, her abdomen and pelvis will be marked with an indelible pen and sometimes also with permanent tiny dots or tattoos. This is to help the operator limit the radiation to the tissue involved with cancer; she must not rub these marks off. She will be told the schedule for the therapy, and when to return for the first treatment.

Counselling and information: immediately before the first treatment session

5. The patient will be given the following information and counselling concerning the entire period of the therapy:
 - Wear loose clothing to avoid potential chafing of the skin.
 - Bathe or shower with luke-warm water. Do not rub or scrub the area being treated. Avoid strong soaps. Dry the affected skin by patting gently with a towel.
 - Do not put anything into the vagina (e.g. tampons) or have sexual intercourse during the entire course of the therapy.
 - Avoid commercially available skin creams; use aqueous cream or petroleum jelly if the skin becomes dry.
 - Cut down on heavy work and work performed in a hot, sweaty environment.
 - Continue with your usual housework or light office work.
 - You may experience some tiredness near the end of the course of treatment, and you should limit your activities accordingly.
 - The repetitive daily treatments will become boring. But keep in mind that the chance of cure is diminished if you miss any appointments or break the schedule, thus delaying the completion of therapy.

Treatment sessions

6. On the first day of treatment, the radiotherapy technician will reconfirm the patient's identity, therapy plan and informed consent. The technician will explain the procedure and show her the therapy machine in its special room.
7. The patient will be placed on the therapy table and told to remain in position. All personnel will leave the room.
8. She will be alone inside the treatment room, but she will be able to talk with and see the technicians on a screen.
9. During treatment, the therapy machine will move several times automatically, or the technician will enter the room to move it.
10. The patient will not feel anything during the therapy, which lasts only a few minutes.
11. Each treatment session will be the same. There will be one treatment per day, usually for five days every week, but this may vary. The total period of treatment is usually 5–6 weeks.
12. The patient will be encouraged to report any problems to the technician. If it is felt she needs a more specialized response, she will be referred to the radiation oncologist.

PS6

13. The radiation oncologist will see the patient once a week for a “treatment check”, and will ask about any signs or symptoms and assess how well the patient is tolerating treatment.
14. The patient will be informed about common side-effects that may start during the five-week period of the therapy and what to do if they occur (see Table PS6.6.1). These side-effects will resolve spontaneously over time once the treatment is finished.

Table PS6.6.1: Side-effects that may occur during teletherapy – how to recognize them and what the patient can do

Side-effect	Signs and symptoms	What to do
Skin response to radiation	<ul style="list-style-type: none"> • Redness starting after about 3 weeks and increasing with treatment • Possibly dry then moist peeling of the skin, especially in the fold between the buttocks 	<p>The patient should only wash the area gently and occasionally, and avoid scrubbing. If painful, she can take mild analgesia.</p> <p>If the reaction is severe (usually because of excessive washing) the radiation oncologist may delay the completion of treatment (this can compromise the cure rate).</p>
Bowel effects (The rectum and terminal colon, which reabsorb water from the bowel contents, are in the pelvic region. Radiation may impair water reabsorption.)	<ul style="list-style-type: none"> • Loose stools or diarrhoea 	<p>The radiation oncologist will prescribe medication if required. Usual household remedies should not be used.</p>
Bladder effects	<ul style="list-style-type: none"> • Urinary frequency and urgency • Burning sensation on passing urine • Evidence of blood in the urine (this is rare) 	<p>The patient should return to the hospital for examination and treatment.</p>

Follow-up

15. The patient will be given an appointment to return between six weeks and three months after completion of the teletherapy. The doctor will examine her and check the vagina to determine if it has healed.
16. The team of cancer specialists, including the radiation oncologist and gynaecologist, are best qualified to assess any symptoms related to the vagina, bowel and bladder. They should be told about any symptoms or signs that appear to be unusual or severe.

What you, a provider at any health-care level, can do for the patient during and after the therapy

1. Help the patient to keep a positive attitude.
2. Counsel the patient and her husband (or partner) that they should not have vaginal or anal intercourse during the treatment and for two weeks thereafter, to allow time for the healing of the vaginal skin, but that other forms of sexual expressions are fine.
3. If the patient is premenopausal, inform her that the treatment will immediately bring on menopause such that there will be no possibility of future pregnancy.
4. Ask the patient to keep up her regular follow-up appointments with the radiation oncologist and gynaecologist team. If she has unusual or severe symptoms, she should make an earlier appointment than scheduled.
5. If she wishes, her family can be a very important part of her support. You can train them in how to help the patient recover from the therapy and achieve a better outcome, for example, by doing her normal household tasks for her, until she regains her strength.
6. Encourage the patient to lie down during the day if she feels tired; make sure she eats well.
7. Inform the woman and her immediate support circle about late complications. Stress that these can all be helped and reduced with professional advice and treatment (see Table PS6.6.2).

Table PS6.6.2: Late complications that may occur after teletherapy – how to recognize them and what to do

Complication	Signs and symptoms	What to do
Onset of menopause (The radiation will cause a premenopausal woman to enter the menopause.)	<ul style="list-style-type: none"> • Lack of menstruation • Hot flushes • Vaginal dryness 	The patient should be informed that this might occur.
Vaginal fibrosis and narrowing of the vaginal tube	<ul style="list-style-type: none"> • Worsening of the vaginal symptoms of menopause; intercourse may become uncomfortable or impossible 	Vaginal lubricants and dilators should be prescribed to keep the vagina free of adhesions. It is important to keep the vagina open to allow inspection of the cervix. Continued sexual activity should be encouraged.
Skin effects (Starting 6 months after treatment, effects may begin to show on the skin exposed to radiation.)	<ul style="list-style-type: none"> • Areas of pigmentation, depigmentation or stiffening 	The patient should be informed that this might occur.
The bladder may become stiff and reduced in size.	<ul style="list-style-type: none"> • Frequent urination • More frequent urinary infections 	The patient should be informed that this might occur.
Long-term narrowing of the rectum (rare)	<ul style="list-style-type: none"> • Very disabling 	The patient should be informed that this might occur.
A passage or fistula between the vagina and the rectum (rare)	<ul style="list-style-type: none"> • Very disabling 	This needs to be specifically managed.
A passage or fistula between the bladder and vagina (rare)	<ul style="list-style-type: none"> • Leakage of urine from the vagina 	This may require surgical repair.

Practice Sheet 6.7: Treatments for cervical cancer: brachytherapy

PS 6

Brachytherapy is a type of radiotherapy delivered from a source of radiation placed close to the tumour, i.e. inside the uterus and in the vaginal vault.

This practice sheet is included to allow a primary- or secondary-level health-care provider to explain to a patient, before she goes to hospital, how the procedure will be performed, and to help her recover once she returns home.

Explaining the brachytherapy procedures

Give the patient as much information as you can on the procedure, the anaesthesia, and the possible side-effects and complications of the therapy. The information and counselling to be provided to the patient are similar to those provided for pelvic teletherapy (see Practice Sheet 6.6). Inform the patient about the anaesthesia or sedation she will receive to make her feel more comfortable. The description provided here will help you answer any questions she may have about brachytherapy.



Pelvic teletherapy

There are two possible brachytherapy procedures: low-dose-rate and high-dose-rate brachytherapy.

Low-dose-rate (LDR) brachytherapy

Preparation

1. The hospital staff will give the patient instructions on how she should prepare before arriving for the therapy (i.e. what clothing to bring and any medicines she should take beforehand).
2. The details of the treatment and its possible complications will be explained, and informed consent requested. The patient will receive an appointment for admission to hospital.

Procedure

3. On the day of the procedure, the patient will be taken to the operating room and given a general anaesthetic; she will not feel anything during the time she is in the operating room.
4. She will have a tube (catheter) placed into her bladder to drain urine. The catheter will be attached to a bag and will remain in place during the treatment.
5. A pelvic examination will be performed.

PS6

6. Through a speculum in the vagina, the brachytherapy catheter device that is made to hold the radioactive substance will be placed into the cervical canal and around it in the vagina. There will be sterile gauze around it to hold it in place.
7. The position of these devices will be checked with X-rays.
8. When the patient wakes up, she will be taken to an isolation ward (shielded room).
9. She will be instructed to remain on her back in bed for the duration of the treatment (1–2 days), although she can be very slightly moved to one side with the help of the nursing staff.
10. The hospital staff will leave the room and the radioactive sources will be loaded under computer control into the metal devices previously inserted close to the tumour.
11. The patient will not feel any pain at all while she is receiving the treatment.
12. During the entire procedure, the door of the room will remain closed. The nursing staff will come in for short periods to check on the patient or to deliver meals (all meals will be served in bed). The patient will need to use a bedpan to empty her bowels. She can spend the time reading, listening to radio or watching television. But she must remain in bed for the entire time. Very limited visiting will be permitted.
13. When the procedure has been completed, the patient will be given a mild sedative and the devices containing the radiation sources will be removed.
14. Once she has recovered from the sedation, she will be discharged from the hospital.



Pain

In some hospitals, two such treatments are given with a one-week interval between them.

High-dose-rate (HDR) brachytherapy

The preparation and procedure are similar to that for LDR brachytherapy, with the following differences:

1. There will be multiple treatment sessions, with each treatment lasting several minutes, but the whole procedure will take about one hour each time.
2. Treatment will usually start in the third week after starting teletherapy and is given on an outpatient basis.
3. It can be performed under mild pain control (analgesia); anaesthesia is seldom used.

The procedure

1. A catheter will be inserted into the patient's bladder to drain urine.
2. After catheterization, repeat bimanual and speculum examinations will be performed and vaginal retractors and speculum inserted.
3. A metal brachytherapy catheter is inserted into the uterus, and attached to the remote afterloading HDR brachytherapy unit that contains the radioactive source.
4. The patient will be told to remain in position while the hospital staff leave the room. She must remain in the same position for the whole time that she is receiving radiation, which takes several minutes.
5. The patient can be discharged when the procedure is over.
6. The number of treatments varies from two to eight, but is usually four. The interval between treatments may vary from one day to one week.
7. After the first treatment, the patient will be given a series of appointments for the rest of the treatments.

Possible side-effects and complications of gynaecological brachytherapy

The side-effects of brachytherapy are the same as those of pelvic teletherapy (see Practice Sheet 6.6, Table PS6.6.1). Brachytherapy contributes substantially to vaginal symptoms of local fibrosis, mucosal atrophy and formation of fragile blood vessels in the vaginal skin, which predisposes the area to local bleeding. It also contributes to late rectal and bladder complications.

Practice Sheet 7.1: Evaluation and treatment of pain²²

Optimal pain management begins with accurate and thorough pain assessment. Pain assessment enables health-care providers to treat pain and alleviate needless suffering. It should be carried out at regular intervals because the disease process and the factors that influence it may change over time and regular assessment permits measurement of the efficacy of different treatment strategies in relieving pain.

A comprehensive approach to pain assessment should be integrated into all clinical care. The way a patient perceives pain is an outcome of biological, psychological, social, cultural and spiritual factors. A patient reporting pain should always be taken seriously, and moderate and severe pain should always be addressed.

Summary of steps for assessing and treating pain:

1. Assess the pain as described in this practice sheet.
2. Record your findings on the patient's chart and in your own records.
3. If you find the cause of the pain, treat the cause, if possible (e.g. bone pain, muscle spasm, gastrointestinal pain from constipation, swelling around the tumour).
4. Use analgesics according to the recommendations in Chapter 7: Palliative care.
5. In addition, you may use appropriate, non-medical treatment, as long as it is not harmful. Non-medical treatment should not replace medical management.
6. Reassess the pain frequently and adjust the treatment accordingly if the pain is not fully controlled. Initially, pain assessment should be several times a day. If the pain stabilizes, it should be assessed daily, and then as needed (this may be several times a week).

Initial pain assessment

The initial pain assessment includes a detailed pain history, a physical examination, the diagnosis of the causes, and the measurement of pain severity using a pain measurement tool. Pain assessment involves obtaining information about the location, duration and characteristics of the pain, as well as the impact of persisting pain on various aspects of the patient's life, such as sleep, emotional state, relationships, development and physical function (1) (see Box PS7.1.1). The health-care provider should try to investigate the pain's association with any triggering

²² Adapted from WHO guidelines on the pharmacological treatment of persisting pain in children with medical illnesses. Geneva: World Health Organization; 2012 (http://whqlibdoc.who.int/publications/2012/9789241548120_Guidelines.pdf).

factors by asking about any known aggravating and relieving factors. The health-care provider should ask what treatments for pain have previously been used, and how effective they were.

A thorough physical examination is essential and each location where there is pain should be carefully evaluated. During the examination, the health-care provider should watch carefully for any reactions, such as facial grimacing, abdominal rigidity, involuntary flexion and verbal cues, which may indicate pain. Any change in normal physical function caused by pain should be assessed.

The information gathered from the history and physical examination will help in the differential diagnosis of the cause(s) of pain, and can guide the choice of laboratory and radiological investigations to confirm diagnosis, if not yet established.

Box PS7.1.1: Questions for the health-care provider to use during clinical evaluation

- Where is the pain and what are its characteristics (site, severity, character of pain as described by the patient, e.g. sharp, burning, aching, stabbing, shooting, throbbing)?
- What number on a scale of 0 to 10 would you give your pain right now? What number would you give your pain when it is the worst that it gets and when it is the best that it gets? At what number is the pain at an acceptable level for you? Use a scale of 0 to 10, where 0 = “none” and 10 = “worst possible”.
 - *If unable to use numbers, use a visual analogue scale based on words, fingers or faces.*
- What makes the pain better or worse? Is it better or worse with movement or at different times of the day? How does the pain change with time?
- How long has the pain been present (duration since onset)? How did the present pain start (was it sudden/gradual)?
- Is there a psychological or spiritual problem in addition to a physical, cancer-related reason for the pain? Are you worried, fearful, depressed or grieving?
- What are you taking for the pain? What works best in relieving the pain?
 - *Once medicines have been prescribed, check often to make sure that the patient is receiving the right doses of the right medicines at the scheduled times.*
- Is the pain disturbing your sleep/emotional state?
- Is the pain restricting your ability to perform normal physical activities (sit, stand, walk, run)? Is the pain restricting your ability to interact with others?

PS7

Documentation of pain: the use of pain measurement tools

Health-care providers need to recognize, evaluate, measure and monitor pain, and pain control strategies, using appropriate pain tools. A variety of pain assessment tools are available (2). The simplest and easiest to use are body diagrams, pain intensity scales, and the faces pain scale. Body diagrams are used to document the site(s) of pain: patients mark the site(s) of their pain on the diagrams (see Figure PS7.1.1). In addition to pain severity measurements and recording the location of pain, it is important to record characteristics, onset and duration. There are conditions where the pain intensity changes not only over time, but also in location and characteristics.

Figure PS7.1.1: Body diagram

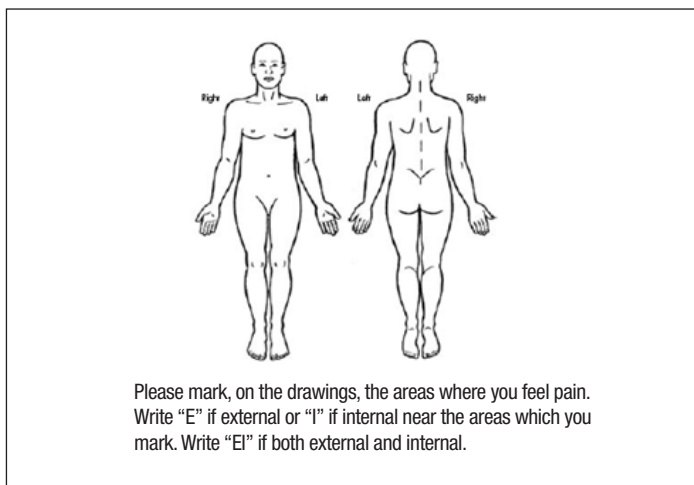

Source: Melzack R. The McGill Pain Questionnaire: major properties and scoring methods. *Pain*. 1975;1:277–99 (with permission of the International Association for the Study of Pain).

The most common pain measurement tools are pain intensity scales, and these rely on the capacity to quantify pain. They are often based on the concept of counting. Practical tools based on the concept of quantifying and counting are appropriate for all cultures. In most adult patients a numerical rating scale (NRS) will be adequate and can be administered verbally or using fingers, without any printed material (3). Alternatives include a visual-analogue scale using numbers, words or pictures of faces (see Figure PS7.1.2). The Wong–Baker Faces Pain Scale (included in Figure PS7.1.2) or the Faces Pain Scale – Revised (see Figure PS7.1.3) are two commonly used pictures of faces for this purpose.

Figure PS7.1.2: Examples of pain rating scales

From top to bottom: numerical rating scale, verbal descriptor scale, the Wong-Baker Faces Pain Scale

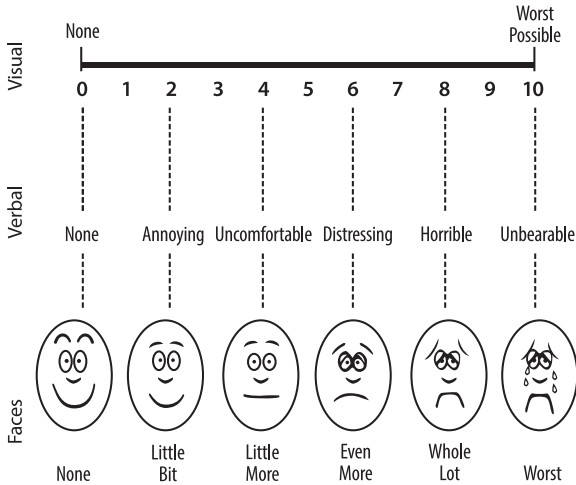

Source: Wong-Baker Faces Pain Scale from Wong DL, Hockenberry-Eaton M, Wilson D, Winkelstein ML. Wong's essentials of pediatric nursing, 6th edition. St. Louis (MO): C.V. Mosby; 2001:1301 (with permission of the International Association for the Study of Pain).

Figure PS7.1.3: Faces Pain Scale – Revised

Source: Faces Pain Scale – Revised, ©2001, International Association for the Study of Pain (www.iasp-pain.org/FPSR).

Pain management plan and regular pain measurement

Following the initial pain assessment, a detailed pain management plan – including pharmacological and nonpharmacological interventions – can be formulated and implemented together with the patient and her primary caregiver.

PS7

Pain measurement should be performed at regular intervals during the implementation of the pain management plan. This permits the measurement of changes in the severity of pain over time, and the assessment of the adequacy and effectiveness of the chosen treatment, and enables adjustments to be made, as necessary.

The patient's initial pain and her response to interventions should be assessed on a regular basis and whenever there are changes in her clinical condition, new reports of pain or increased levels of pain. Pain-control therapies should be adjusted accordingly. In patients with stable persisting pain, pain should still be assessed on a regular basis with shorter intervals. Measurements should be recorded over time in the patient's clinical chart or by the patient or her caregivers in a journal. Pain rating should be by self-report whenever possible (4). Self-reporting of pain is also feasible in individuals with mild to moderate cognitive impairment and should always be attempted initially (5).

Box PS7.1.2: Step-by-step guidance for administering and interpreting a self-report pain scale

- If possible, introduce the patient to the pain scale when she is not in pain, because pain will affect her concentration.
- Explain to her that the measure is for the pain severity and not for her anxiety or fear of the pain.
- Offer her a chance to practice with the scale by rating hypothetical situations that produce no, low and high levels of pain.
- When possible, obtain regular pain ratings and observe the effect of pain-relieving interventions as well as clinical interventions known to increase pain, such as injections.
- Take recorded pain scores into account when planning treatment.
- Avoid asking the patient to score pain she experienced a long time ago, as recalled pain scores are unlikely to be accurate.
- Obtaining pain scores should not be a substitute for talking to the patient and her narrative should always be obtained.
- Discrepancies arising in the pain scores provided by the patient and the clinician can often be resolved through discussion.

Source: adapted from von Baeyer CL. Children's self-reports of pain intensity: scale selection, limitations and interpretation. *Pain Res Manag.* 2006;11:157–62.

Health-care providers may perceive the assessment of persisting pain as a time-consuming process. Therefore, educating health-care providers about the importance of pain assessment is necessary in order to provide quality treatment. Pain assessment is a mandatory part of pain management, similar to the role of assessing vital signs in order to manage disorders affecting other system functions. Health-care providers should be trained in the techniques for assessing and grading pain with easy-to-use tools, as well as in interviewing skills and knowledge of how to work across any cultural and language barriers.

References

1. Palermo TM. Assessment of chronic pain in children: current status and emerging topics. *Pain Res Manag.* 2009;14:21–6.
2. Flaherty SA. Pain measurement tools for clinical practice and research. *J Am Assoc Nurse Anesth.* 1996;64(2):133–40.
3. von Baeyer CL, Spagrud LJ, McCormick JC, Choo E, Neville K, Connelly MA. Three new datasets supporting use of the Numerical Rating Scale (NRS–11) for children’s self-reports of pain intensity. *Pain.* 2009;143:223–7. doi:10.1016/j.pain.2009.03.002.
4. To TH, Ong WY, Rawlings D, Greene A, Currow DC. The disparity between patient and nurse symptom rating in a hospice population. *J Palliat Med.* 2012;15(5):542–7. doi:10.1089/jpm.2011.0291.
5. Ni Thuathail A, Welford C. Pain assessment tools for older people with cognitive impairment. *Nurs Stand.* 2011;26(6):39–46.

Practice Sheet 7.2: How to manage vaginal discharge, fistulae and bleeding at home

This practice sheet is intended to assist primary-level, community-based and home-based caregivers on how to provide care and comfort for women with advanced cervical cancer living at home (or at another place that is not a health-care facility). It contains advice on how to reduce the pain, suffering and shame these women feel as a result of sometimes very foul-smelling vaginal discharge, fistulae and bleeding. These can be caused by the disease itself and/or complications of hospital treatment. Most of the suggestions in this practice sheet can be implemented to help patients using materials found in most homes.

This advice is not meant to replace other efforts to remove the patient's pain and discomfort; pain management is essential for severely ill patients and has to be frequently monitored, assessed and treated accordingly (see Chapter 7 and Practice Sheet 7.1). In addition to pain management and the specific advice in this practice sheet, supportive, emotional and other non-medical measures can also be very effective.

Supplies needed for home-based management of vaginal problems:

- a constant supply of clean, boiled water;
- soap, for washing hands and clothes;
- clean towels;
- latex gloves, if possible (need not be sterile);
- plastic sheeting or newspapers;
- bags for disposal of contaminated materials;
- chlorinated water (1 cup of bleach to 6 cups of water) for soaking gloves, wiping down furniture and plastic sheeting, etc.;
- a basin for sitting baths;
- a plastic bottle and tube for douching;
- plenty of clean cloths, or cotton, or menstrual pads, if possible (cloths should be boiled first if they are going to be used to pack the vagina);
- sodium bicarbonate (baking soda);
- vinegar;
- zinc oxide cream or petroleum jelly;
- antibiotics and other medicines prescribed by the physician (e.g. metronidazole, doxycycline, amoxicillin).

Prevention of infections

To avoid causing an additional bacterial vaginal infection in the patient, and to prevent the caregiver from getting infections by way of any broken skin on their hands, please remember that the caregiver must wash her hands and scrub her nails with soap and

water or with an antiseptic solution provided by a health-care facility. Even better, if there is a supply of disposable gloves, these should be used on both hands.

In addition, all non-reusable supplies must be disposed of according to the regulations in your community and all soiled reusable supplies (e.g. rags, pads, bedding, douche equipment) must be washed by first soaking them for 10 minutes in clean water with some chlorine bleach added, and then washing them as usual.

Managing vaginal discharge

Women with cervical cancer may have watery, bloody, foul-smelling vaginal discharge, caused by the severely damaged vaginal tissues; it is likely that a bacterial infection is the primary cause of the smell. The bacteria cannot be permanently eliminated, but symptoms can be temporarily alleviated by doing one or more of the following:

- The patient can sit in warm water to gently clean herself.
- Cover the bed with a plastic sheet or newspapers, which can be changed and/or cleaned frequently with chlorine water.
- Protect the skin around the vagina and anus by drying the areas after bathing and covering them with zinc oxide cream or petroleum jelly. These measures can be used in a preventive way, without waiting for irritation to occur.
- Ventilate the room or burn incense or herbs, if this is acceptable.
- Absorb the discharge with frequent changes of clean cloths, cotton or menstrual pads, placed in the underpants.
- Carry out periodic, careful vaginal douching (rinsing the vagina using a tube attached to a clean plastic bottle or syringe), using one of the following solutions made at home with boiled water at warm temperature:
 - 1 tablespoon of sodium bicarbonate (baking soda) in 2 cups of water; or
 - ½ cup of vinegar in 2 cups of water; or
 - 5–10 crushed tablets of metronidazole (which may be obtained from the nearest primary care centre) dissolved in 2 cups of water.
- Gently pack the vagina twice a day with clean cloths soaked in one of the above solutions. Packs should not be left in place for more than a few hours.
- Broad-spectrum antibiotics may be prescribed by a clinical provider, but they should be used with caution because they are, at best, only temporarily effective. In addition, they can cause a yeast infection in the vagina, which can make symptoms worse.

- The following antibiotics can be given by mouth for a minimum period of seven days: doxycycline 100 mg twice a day; or amoxicillin 500 mg, three times a day, plus metronidazole 400–500 mg twice a day.
- If an antibiotic is prescribed, it is important for the patient to complete the course of treatment; not completing it may worsen the problem.

Managing fistulae

A fistula is an abnormal passage between the vagina and the urinary bladder or the rectum. In the case of cervical cancer patients, it is caused either by extension of the cancer into these organs or as a complication of radiotherapy. It is a psychologically and physically debilitating condition, because urine or faeces may pass directly to the vagina, causing a foul-smelling and irritating discharge. The advice given for managing vaginal discharge can be used for any woman who has a fistula and for all women with advanced cervical cancer. The fistula itself cannot be repaired, but the patient can be made more comfortable and clean by all the methods listed in the previous section, except that the vagina should not be douched or packed.

Managing vaginal bleeding

Vaginal bleeding can be alarming and is not uncommon in women with advanced cervical cancer. It can be triggered by inserting anything into the vagina; please exercise caution when douching or packing the vagina, and also advise partners to find other pleasurable sexual activities to replace intercourse. Vaginal bleeding may also occur spontaneously for no obvious reason.

- If bleeding is slight, recommend bed rest and keeping the skin clean until it stops.
- If bleeding is moderate, it often subsides with simple bed rest. If needed, the lower vagina can be gently packed with a clean moistened cloth for a few hours.
- If bleeding is severe, transfer the patient to a hospital or health centre for a possible blood transfusion.

Practice Sheet 7.3: Conversations with a patient who is returning home under palliative care

PS 7

“TO DOs” for conversing with the patient when she returns home

- When having conversations about palliative care, always be mindful of cultural aspects of the patient’s community.
- Ask: “How are you feeling?”, “Are you having any problems or unpleasant symptoms at the moment?” and “How are these problems making your life more difficult?”
- Explain the reasons that she was discharged from hospital. For example, “The doctors felt that you could be better supported and treated at home, surrounded by your family and close friends who are the best people to provide you with comfort and peace”.
- Now that she is home, ask the patient whom she has near her to provide physical assistance, and emotional and spiritual support.
- Volunteer to accompany her when the potential helpers are approached and when making plans for specific help.
- Ask the patient if and how much pain she is feeling, and assure her that in almost all cases pain can be successfully managed at home and that this help will be provided to her whenever it is needed.
- Assure her that the medicines she will receive for pain are not addictive.
- Ask her about other symptoms and reassure her that you will consult providers at all levels to prescribe the needed treatment.
- Assure her that now, as always, her well-being is at the centre of all that is being done.
- Inform her that the community caregiver is always available and that she only needs to call her by phone or send someone to find her.

see Counselling tips following page

PS7

Counselling tips

- Visit the patient as often as possible.
- Always listen to the patient's and her family's complaints, and try to relieve any symptoms.
- Maintain communication with providers at the health centre or hospital and seek their advice for specific problems.
- Address fears by explaining the reasons for the symptoms, and reassure the family that you will do all you can to keep the patient comfortable.
- Instruct the patient and her family in symptom management.
- Assist them in obtaining needed supplies.
- Most importantly, try to avoid burn-out for yourself by avoiding overwork, maintaining close relationships, and seeking the support of those close to you (without breaching patient confidentiality).

Annex 1. Lists of participants and contributors

Guideline Development Group (GDG)

Irene Agurto (*Chapter 3*)

WHO Consultant
Santiago, Chile

Marc Arbyn (*Chapter 5*)

Unit of Cancer Epidemiology
Scientific Institute of Public Health –
Louis Pasteur
Brussels, Belgium

Paul D. Blumenthal (*Chapters 1 and 5*)

Population Services
Department of Obstetrics and
Gynecology Stanford University
School of Medicine
Stanford, CA, USA

Loretta Brabin (*Chapter 3*)

School of Cancer and Enabling Sciences
St Mary's Hospital
Manchester, United Kingdom

August Burns (*Chapter 3*)

Grounds for Health
Waterbury, VT, USA

Joanna Cain (Chair) (*Chapters 5 and 6*)

International Federation of Gynecology
and Obstetrics
London, United Kingdom

Michael Chirenje (*Chapters 5 and 6*)

Department of Obstetrics and
Gynecology
University of Zimbabwe Medical School
Harare, Zimbabwe

Swee Chong Quek (*Chapters 5 and 6*)

Department of Gynecological Oncology
KK Women's and Children's Hospital
Singapore

Stephen Connor (*Chapter 7*)

Worldwide Palliative Care Alliance
London, United Kingdom

Lynette Denny (*Chapters 5 and 6*)

Department of Obstetrics and Gynaecology
Groote Schuur Hospital
Cape Town, South Africa

Maria Fernandez (*Chapter 3*)

Health Education/Social Sciences
University of Texas Health Science Center
Houston, TX, USA

Sara Forhan (*Chapter 5*)

HIV Care and Treatment Branch
Global AIDS Program
Centers for Disease Control and Prevention
Atlanta, GA, USA

Eduardo Franco (*Chapters 1 and 5*)

Division of Cancer Epidemiology
McGill University
Montreal, Canada

Julia C. Gage (*Chapter 5*)

Clinical Genetics Branch
Division of Cancer Epidemiology and
Genetics
National Cancer Institute
Rockville, MD, USA

Francisco Garcia (*Chapter 5*)

American Cancer Society
Tucson, AZ, USA

Susan Hariri (*Chapter 4*)

Division of STD Prevention
National Center for HIV/AIDS, Viral
Hepatitis, STD, and TB Prevention
Centers for Disease Control and
Prevention
Atlanta, GA, USA

Eline Huisman (*Chapter 7*)

Utrecht University
Utrecht, Netherlands

José Jerónimo (*Chapters 5 and 6*)

PATH
Seattle, WA, USA

Sharon N. Kibwana (*Chapters 2 and 3*)

Jhpiego
Baltimore, MD, USA

Nancy Kidula (*Chapter 3*)

ACCESS Uzima, Jhpiego
Nairobi, Kenya

Enriqueito R. Lu (*Chapters 2, 3 and 5*)

Jhpiego
Baltimore, MD, USA

Ian Magrath (*Chapter 6*)

International Network for Cancer
Treatment and Research (INCTR)
Brussels, Belgium

Valerie Mazeau-Moynar (*Chapter 6*)

National Cancer Institute
Department of Cancer Screening
Boulogne-Billancourt, France

Daniela Mosoiu (*Chapters 3, 6 and 7*)

Educatie, Strategie si Dezvoltare Nationala
Hospice Casa Sperantei
Brasov, Romania

Raul Murillo (*Chapters 2 and 4*)

Subdireccion Investigaciones y Salud
Pública
Instituto Nacional de Cancerología de
Colombia
Bogotá, Colombia

Fidele Ngabo (*Chapter 4*)

Maternal and Child Health Department
Ministry of Health
Kigali, Rwanda

Linda O'Neal Eckert (*Chapters 1 to 7*)

University of Washington
Seattle, WA, USA

Groesbeck Parham (*Chapter 6*)

Center for Infectious Research in Zambia
Lusaka, Zambia

Silvia de Sanjosé (*Chapter 1*)

Catalan Institute of Oncology
L'Hospitalet de Llobregat
Barcelona, Spain

Mona Saraiya (*Chapters 3 and 6*)

National Center for Chronic Disease
Prevention and Health
Centers for Disease Control and Prevention
Atlanta, GA, USA

Judith L. Smith (*Chapter 3*)

Behavioral and Applied Research Team
Division of Cancer Prevention and Control
Centers for Disease Control and Prevention
Atlanta, GA, USA

Tshewang Tamang (*Chapter 4*)

Vaccine Preventable Disease Program
Ministry of Health
Thimphu, Bhutan

Vivien Tsu (*Chapters 2 and 5*)

PATH
Seattle, WA, USA

Maggie Watson (*Chapter 7*)

Service of Psychological Medicine
Royal Marsden Hospital
Surrey, United Kingdom

Deborah Watson-Jones (*Chapter 4*)

London School of Hygiene and Tropical
Medicine
London, United Kingdom

Phil Wiffen (*Chapter 7*)

Nuffield Department of Clinical
Neurosciences
University of Oxford
Oxford, United Kingdom

Scott Wittet (*Chapter 3*)

Cervical Cancer Prevention Programs
PATH
Seattle, WA, USA

WHO Steering Group**Rachel Baggaley**

HIV/AIDS Department
WHO, Headquarters
Geneva, Switzerland

Paul Bloem

Immunization, Vaccines and Biologicals
WHO Headquarters
Geneva, Switzerland

Freddie Bray

Section of Cancer Information
International Agency for Research on
Cancer
Lyon, France

Nathalie Broutet

Reproductive Health and Research
WHO Headquarters
Geneva, Switzerland

Meena Cabral De Mello

Maternal, Newborn, Child and Adolescent
Health
WHO Headquarters
Geneva, Switzerland

Venkatraman Chandra-Mouli

Reproductive Health and Research
WHO Headquarters
Geneva, Switzerland

Jean-Marie Dangou

Disease Prevention and Control
WHO Regional Office for Africa
Brazzaville, Republic of Congo

Islene Araujo De Carvalho

Ageing and Life Course
WHO Headquarters
Geneva, Switzerland

Hugo De Vuyst

Early Detection and Prevention
International Agency for Research on
Cancer
Lyon, France

Ibtihal Fadhil

Division of Noncommunicable Diseases
and Mental Health
WHO Regional Office for the Eastern
Mediterranean
Cairo, Egypt

Jane Ferguson

Maternal, Newborn, Child and
Adolescent Health
WHO Headquarters
Geneva, Switzerland

Mario Festin

Reproductive Health and Research
WHO Headquarters
Geneva, Switzerland

Tracey Goodman

Immunization, Vaccines and Biologicals
WHO Headquarters
Geneva, Switzerland

Sandra Gove

HIV/AIDS Department
WHO Headquarters
Geneva, Switzerland

Marie-Agnes Heine

Communications
WHO Headquarters
Geneva, Switzerland

Rolando Herrero

Early Detection and Prevention
International Agency for Research on
Cancer
Lyon, France

Raymond Hutubessy

Immunization, Vaccines and Biologicals
WHO Headquarters
Geneva, Switzerland

Regina Kulier

Knowledge, Ethics and Research
WHO Headquarters
Geneva, Switzerland

Gunta Lazdane

Sexual and Reproductive Health
WHO Regional Office for Europe
Copenhagen, Denmark

Silvana Luciani

Chronic Diseases Prevention and Control
WHO Regional Office for the Americas
Pan American Health Organization
Washington, DC, USA

Melody Maarouf

Reproductive Health and Research
WHO Headquarters
Geneva, Switzerland

Amolo Okero

HIV/AIDS Department
WHO Headquarters
Geneva, Switzerland

Anayda Gerarda Portela

Maternal, Newborn, Child and Adolescent
Health
WHO Headquarters
Geneva, Switzerland

Somchai Peerapakorn

WHO Country Office
Nonthaburi, Thailand

Rengaswamy Sankaranarayanan

Early Detection and Prevention
International Agency for Research on
Cancer
Lyon, France

Willem Scholten

Essential Medicines and Health Products
WHO Headquarters
Geneva, Switzerland

Timo Stahl

Prevention of Noncommunicable
Diseases
WHO Headquarters
Geneva, Switzerland

Kwok-Cho Tang

Prevention of Noncommunicable
Diseases
WHO Headquarters
Geneva, Switzerland

Igor Toskin

Reproductive Health and Research
WHO Headquarters
Geneva, Switzerland

Andreas Ullrich

Management of Noncommunicable
Diseases
WHO Headquarters
Geneva, Switzerland

Andrea Vicari

Immunization
WHO Regional Office for the Americas
Pan American Health Organization
San José, Costa Rica

Adriana Velazquez

Essential Medicines and Health Products
WHO Headquarters
Geneva, Switzerland

Cherian Varghese

Noncommunicable Diseases and Health
Promotion
WHO Regional Office for the Western Pacific
Manila, Philippines

Marco Vitoria

HIV/AIDS Department
WHO Headquarters
Geneva, Switzerland

Lawrence von Karsa

Early Detection and Prevention
International Agency for Research on
Cancer
Lyon, France

Susan Wang

Immunization, Vaccines and Biologicals
WHO Headquarters
Geneva, Switzerland

Methods Group**Chapter 5:****Tahany Awad**

Department of Clinical Epidemiology and
Biostatistics
McMaster University
Hamilton, Canada

Rohan Kehar

Michael G. DeGroot School of Medicine
McMaster University
Hamilton, Canada

Reem Mustafa

Department of Clinical Epidemiology and
Biostatistics
McMaster University
Hamilton, Canada

Nancy Santesso

Department of Clinical Epidemiology and
Biostatistics
McMaster University
Hamilton, Canada

Holger Schunemann

Department of Clinical Epidemiology and
Biostatistics
McMaster University
Hamilton, Canada

External Review Group (ERG)**Elisabeth Andritsch**

Department of Internal Medicine
Medical University of Graz
Graz, Austria

Ahti Anttila

Finnish Cancer Registry
Helsinki, Finland

Partha Sarathi Basu

Chittaranjan National Cancer Institute
Kolkata, India

John-Paul Bogers

Faculteit Geneeskunde
Campus Groenenborger
Antwerp, Belgium

Xavier Bosch

Institut Català d'Oncologia
Barcelona, Spain

Rolando Camacho-Rodriguez

International Atomic Energy Agency
Vienna, Austria

James Cleary

WHO Collaborating Center for Pain, Policy
and Palliative Care
Madison, WI, USA

Anne Garnier

Institut National du Cancer (INCa)
Boulogne-Billancourt, France

Martha Jacob

WHO Consultant
Kochi, Kerala State, India

Jessica Kahn

Cincinnati Children's Hospital Medical
Center
Cincinnati, OH, USA

Namory Keita

Donka Teaching Hospital
Conakry, Republic of Guinea

Rajshree Jha Kumar

Kailash Darshan
Mumbai, India

Anne Levin

WHO Consultant Health Economist
Bethesda, MD, USA

Khunying Kobchitt Limpaphayom

Faculty of Medicine
Chulalongkorn University
Bangkok, Thailand

Emmanuel Mugisha

PATH
Kampala, Uganda

Daniel Murokora

Uganda Women's Health Initiative
Kampala, Uganda

Meg O'Brien

American Cancer Society
Washington, DC, USA

Oneko Olola

Kilimanjaro Christian Medical Center
Moshi, Tanzania

Nuriye Ortayli

UNFPA
New York, NY, USA

Patrick Petignat

Hôpitaux Universitaires de Genève
Geneva, Switzerland

Ilka Rondinelli

International Planned Parenthood
Federation
London, United Kingdom

Carlos Santos

Instituto Nacional de Enfermedades
Neoplasicas
Lima, Peru

Achim Schneider

Charité Universitäts Medizin Berlin
Berlin, Germany

Nereo Segnan

San Giovanni University Hospital
Turin, Italy

Nguyen-Toan Tran

WHO Consultant
Geneva, Switzerland

Julie Torode

International Union Against Cancer
Geneva, Switzerland

Jérôme Viguier

Institut National du Cancer (INCa)
Boulogne-Billancourt, France

Steven Weyers

Ghent University Hospital
Gent, Belgium

Katherine Worsley

Marie Stopes International
London, United Kingdom

Eduardo Zubizarreta

International Atomic Energy Agency
Vienna, Austria

Writers

A1

Annex 1. Lists of participants and contributors

August Burns

Grounds for Health
Waterbury, VT, USA

Linda O'Neal Eckert

University of Washington
Seattle, WA, USA

Susan Hariri

Centers for Disease Control and Prevention
Atlanta, GA, USA

Martha Jacob

WHO Consultant
Kochi, Kerala State, India

Emma Ottolenghi

WHO Consultant
Waterbury, VT, USA

Editing**Jane Patten**

Green Ink Publishing Services Ltd.
United Kingdom
www.greenink.co.uk

Annex 2. Guideline development methodology, roles of the technical and working groups, and management and declarations of conflicts of interest

A2

Annex 2. Guideline development methodology, roles of the technical and working groups, and management and declarations of conflicts of interest

WHO invited a group of experts to a meeting in September 2010 to decide on the update of *Comprehensive cervical cancer control: a guide to essential practice* (C4GEP), which was originally published in 2006. The major conclusions were that the chapters needed to be reorganized, new chapters needed to be added on health education and on HPV vaccines, the chapter on screening and treatment of precancerous lesions for cervical cancer prevention required updating, and the palliative care chapter needed review. The group of experts at this meeting also made recommendations to WHO on the composition of the Guideline Development Group (GDG). Some of these experts also became part of the External Review Group (ERG). A total of 72 experts were involved: 35 in the GDG, 29 in the ERG, 7 in the Methods Group, and one writer who was not included in any of the groups. The lists of participants in each group are provided in Annex 1, including indication of which chapters they worked on.



Participants and contributors

Sub-divisions of the GDG were formed for the purposes of revising, reorganizing or developing each chapter. In 2011, these sub-groups met twice to discuss each chapter.

- **Chapters 1, 2 and 3** do not include recommendations and were developed based on an in-depth literature review, but not using the GRADE methodology (Grading of Recommendations Assessment, Development and Evaluation).¹
- **Chapters 4 and 5** are based on the recommendations related to the use of HPV vaccines and to screening and treatment for cervical cancer prevention, respectively. These recommendations have all been through the formal WHO process for development of recommendations (references to the WHO recommendations are included in the chapters).
- **Chapter 6** does not include recommendations but presents an in-depth review of the practices for cervical cancer management. The information provided will enable providers to counsel patients who need to be referred for cancer treatment.
- **Chapter 7** includes recommendations on palliative care; this chapter has been developed following the GRADE process.

¹ Further information available at: <http://www.gradeworkinggroup.org/> (about the GRADE working group) and http://www.who.int/kms/guidelines_review_committee/en/ (about WHO's Guideline Review Committee)

In April 2012, the entire GDG, the Methods Group and the ERG met in a joint session over several days and reviewed the seven chapters of C4GEP. The main objectives of this review were to be sure that the chapters were all in line with existing WHO recommendations and that the flow of the chapters was easy to follow.

In 2012, 2013 and 2014, the team of writers worked in very close collaboration with the WHO Coordinating Team to finalize the document and to start the editing and layout process. Between the writing sessions, chapters were sent to the GDG for review and approval. The main substantive comments from the ERG were obtained during the April 2012 meeting.

Management of conflicts of interest

Conflicts of interest were managed as follows:

1. All experts who participated in the process were required to complete the WHO declaration of interest (DOI) form before they commenced their work for WHO, and to promptly notify WHO if any change in the disclosed information occurred during the course of this work. The completed DOI forms were reviewed by the WHO Secretariat with a view to managing disclosed interests in the field of cervical cancer prevention and control.
2. At the initial meeting of the ERG in September 2010 and at the first joint meeting of the GDG, the Methods Group and the ERG in 2012, each expert disclosed his/her declared interests to the other experts as part of the round of introductions at the beginning of the meeting so that the group was aware of any existing interests among the members.
3. All declared interests have been reviewed by WHO's Office of the Legal Counsel. The decision was that all experts could participate in the process but interests should be disclosed in the guideline.
4. All relevant declared interests (19 out of 72 experts) are summarized below.

Declarations of interest

Out of the 72 experts who participated in this work, 19 (15 from the GDG and 4 from the ERG) declared an interest related to cervical cancer. None of these declared interests were important enough to exclude the expert from the discussions. All relevant interests are disclosed and summarized below.

For the Guideline Development Group:

Marc Arbyn (Chapter 5) was invited by the European Research Organisation on Genital Infection and Neoplasia (EUROGIN) to speak at its 2011 conference in Lisbon. EUROGIN covered his travel and lodging expenses. EUROGIN is an organization that promotes and develops, at the level of the European region, research, training,

screening, prevention and information concerning genital infections, pre-cancers and cancers in women. EUROGIN conferences are financially supported by a range of pharmaceutical companies with an interest in cervical cancer.

Paul Blumenthal (Chapter 5) was the principal investigator of an operations research study conducted by the Department of Obstetrics and Gynecology at Stanford University School of Medicine to evaluate the feasibility and acceptability of introducing a new rapid HPV test (careHPV) manufactured by Qiagen for low- and middle-income settings. Qiagen lent the equipment and provided the tests for this research.

Loretta Brabin (Chapter 3) from the University of Manchester, United Kingdom, was the principal investigator of a two-year study on the acceptability and feasibility of vaccinating school-attending adolescent girls against HPV. Her university received £320 493 in funding for this study from GlaxoSmithKline (GSK). Brabin received £2000 in funds for travel and participation in conferences. Brabin was part of the Guideline Development Group (GDG) and participated exclusively in the review of Chapter 3: Community mobilization, education and counselling. This chapter does not include recommendations; rather it reviews and highlights the work that has been done on messages related to HPV infection, HPV vaccines, and cervical cancer, among other things.

Swee Chong Queck (Chapters 5 and 6) has, over the past four years, participated in advisory board meetings and speakers' forums organized by GSK and Qiagen. These meetings and forums related to cervical cancer prevention strategies, HPV vaccine efficacy studies and clinical relevance of HPV vaccination for the prevention of cervical cancer and other HPV-related diseases. The total combined income received by Queck for these activities over the last four years was S\$ 9000 (Singapore dollars).

Lynette Denny (Chapters 5 and 6) has spoken on HPV vaccination at various speakers' forums organized by the companies GSK and Merck. The honoraria for these activities amounted to approximately US\$ 4000 per company per year and were paid to her employer, the University of Cape Town. The Department of Obstetrics and Gynaecology of the University of Cape Town, of which Denny is the head, has furthermore conducted two HPV vaccine trials for GSK and Merck. For these trials the University of Cape Town received US\$ 1.6 million from GSK, but no funding from Merck as that funding was paid to the Department of Health, KwaZulu Natal. All work done on the project by Denny was done pro bono. Denny gave a talk on cost-effectiveness of HPV testing in Hong Kong, in 2012, and Qiagen paid for her registration, travel and accommodation. Denny is currently running a trial for Roche on the ability of the cobas® 4800 System to detect cancer – the cost is US\$ 25 000. All the funds received by Denny either as a principal investigator or as a speaker are paid entirely to the University of Cape Town research accounts.

Eduardo Franco (Chapters 1 and 5) has participated in advisory board meetings and forums relating to cervical cancer prevention strategies organized by Merck, Roche and Gen-Probe (either on HPV vaccines or HPV tests). He has received an average honorarium of US\$ 4000 per company for these activities over the last four years.

Julia Gage (Chapter 5) has, as part of her work for the United States National Cancer Institute (NCI) of the National Institutes of Health (NIH), conducted an operations research project in Nigeria to evaluate the effectiveness of the careHPV screening test manufactured by Qiagen. Qiagen donated and shipped the reagents, equipment and supplies. NCI paid for all other aspects of the study.

Francisco Garcia (Chapter 5) was the principal investigator for drug trials of novel agents for the treatment of cervical cancer while he was employed at the University of Arizona. These trials were conducted by the University of Arizona under research contracts with Roche (US\$ 150 000), Inovio (US\$ 70 000), Photocure (US\$ 120 000) and Roche/Ventana (US\$ 100 000). Garcia did not receive any personal income for these trials.

José Jerónimo (Chapters 5 and 6) is an employee of PATH, an international non-profit organization involved in the development and delivery of high-impact, low-cost tools for global health. PATH has concluded collaborative research and development agreements for the development of a rapid HPV test with Qiagen (careHPV) and a rapid test for cervical cancer screening with Arbor Vita (identification of the E6 and E7 oncoproteins). PATH has received samples and equipment from both companies to conduct studies in different countries for the validation of these tests. Jeronimo is currently involved in a project for large-scale introduction of HPV testing in the population-based cervical cancer prevention programmes of multiple countries; he is collaborating in the development, evaluation and introduction of new treatment options for cervical pre-cancer.

Enriquito Lu (Chapters 2 and 5) was the principal investigator of an HPV vaccination study conducted by his employer, the international, non-profit organization Jhpiego, under agreement with Merck. The purpose of the study was to evaluate the feasibility and acceptability of a strategy to deliver comprehensive cervical cancer prevention services in Thailand and the Philippines by integrating HPV vaccination for girls aged 9–13 into screening and treatment programmes for mothers. For this purpose, Jhpiego received from Merck US\$ 850 000 and HPV vaccines for up to 4000 girls in each country project site. Lu did not receive any personal income for his work on this study.

A2

Raul Murillo (Chapters 2 and 4) was a consultant for GSK to analyse the cost-effectiveness of the HPV vaccine. He received a total honorarium of US\$ 5000 for this consultancy (which ended in 2010).

Silvia de Sanjosé (Chapter 1) has received occasional travel support from Sanofi, Merck, and Qiagen to attend and present results of studies coordinated by her institution at national and international conferences. The amounts ranged from approximately US\$ 1000 to US\$ 3000 per trip, depending on the location of the conference. None of the funders had any role in the presentations of results. Some research studies in which de Sanjosé participates have been partially supported by GSK, Sanofi Pasteur Merck Sharp & Dohme Corp. (SPMSD), Qiagen, Roche and Merck & Co., Inc., representing over US\$ 100 000 a year for the last four years. None of the funders have had any role in the data collection, analysis or interpretation of the results.

Vivien Tsu (Chapters 2 and 5) is an employee of PATH, an international non-profit organization involved in the development and delivery of high-impact, low-cost tools for global health. As such, Tsu was involved in: (1) large-scale demonstration projects on the prevention, screening and treatment of cervical cancer in developing countries for which PATH received donated vaccine from GSK and Merck and careHPV tests from Qiagen; and (2) an alternative-dose-schedule study in Viet Nam, for which PATH received donated vaccine from Merck. PATH has received vaccine vials from the manufacturers for the large-scale project, equivalent to US\$ 13.9 million from Merck and US\$ 9.1 million from GSK. It is to be noted that the grants mentioned above stopped in 2009 and 2010, respectively.

Deborah Watson-Jones (Chapter 4) from the London School of Hygiene and Tropical Medicine was the principal investigator of a phase IIIB safety and immunogenicity trial of the bivalent vaccine in healthy HIV-negative girls aged 10–25 years. For this study, her institution received funds from GSK up to £898 104. She also led the HPV vaccine pilot study in Mwanza Region, which received 15 750 vials of the quadrivalent vaccine through the Gardasil Access Programme. Watson-Jones participated in the review of Chapter 4: HPV vaccination, to ensure the accuracy of the language. No new recommendations were developed in this chapter. This chapter conforms strictly to the WHO recommendations on the use of HPV vaccines published in 2009 and the revised Strategic Advisory Group of Experts on Immunization (SAGE) recommendations on the use of HPV vaccines published in April 2014.

Scott Wittet (Chapter 3) is an employee of PATH, an international non-profit organization involved in the development and delivery of high-impact, low-cost tools for global health. As such, Wittet was involved in: (1) large-scale demonstration projects on the prevention, screening and treatment of cervical cancer in developing countries for which PATH received donated vaccine from GSK and Merck and careHPV tests from Qiagen; and (2) an alternative-dose-schedule study in Viet Nam, for which PATH received donated vaccine from Merck. PATH has received vaccine vials from the manufacturers for the large-scale project, equivalent to US\$ 13.9 million from Merck and US\$ 9.1 million from GSK. Wittet is a communication expert and was part of the GDG. He participated in the development and review of Chapter 3: Community mobilization, education and counselling. It is to be noted that the grants mentioned above stopped in 2009 and 2010, respectively.

For the External Review Group:

John-Paul Bogers (Chapters 5 and 6) is employed by the University of Antwerp and acts as a consultant for SonicHealthcare Benelux to perform clinical pathology work and validate new technologies in the field of treatment of cervical intraepithelial neoplasia (CIN). SonicHealthcare Benelux is a commercial laboratory that inter alia performs cervical cancer (cytology and HPV) screening. Bogers has also performed work for three other companies with an interest in cervical cancer screening: (1) an analytical validation of an HPV test for Innogenetics (contract value: €60 000); (2) an analytical validation of a Becton–Dickinson pathway machine (contract value: €10 000); and (3) a literature review in the field of treatment of CIN for Hologic (contract value: €5000).

François Xavier Bosch (Chapter 1) from the Institute Catalane de Oncologia in Spain received a significant amount of funds and vaccine donation for his institution and Phase II–III trials, from GSK, Merck Sharp & Dohme Corp. (MSD), Qiagen and SPMSD, as unrestricted education and research grants. He also received funds for travel and participation in advisory board meetings for these companies. These are ongoing grants and activities. It is to be noted that Bosch did not participate in the development of any of the recommendations. He participated as an expert in the epidemiology of cervical cancer and HPV in the review of Chapter 1: Background.

Jessica Kahn (Chapter 3) from Cincinnati Children's Hospital in the United States served as co-chair of two clinical trials of HPV vaccine in men and women living with HIV, funded by the United States NIH, for which Merck provided vaccines and immunogenicity tests. Kahn also served as the chair of a grant review committee of the Society for Adolescent Health and Medicine for demonstration projects to improve adolescent vaccination. The Society received unrestricted funds from Merck to run the grant programme. Kahn received salary support from the Society to run the grant

programme. As an adolescent health specialist, Kahn participated exclusively in the review of Chapter 3: Community mobilization, education and counselling. Her main contribution to the review related to information on how to reach adolescents and communicate with them.

Achim Schneider (Chapter 6) from the Charité Centrum in Berlin served as a member of the advisory board and a lecturer for GSK, Sanofi Pasteur and Karl Storz, for which he received €15 000, €5000, and an annual amount of €40 000, respectively. Since 2013, Schneider has not received any support from GSK or Sanofi Pasteur, and since October 2013, he has not received any support from Karl Storz.

A2

Annex 3. Infection prevention and control

A3

Annex 3. Infection prevention and control

Standard (routine or basic) infection prevention and control (IPC) precautions are simple measures and must be applied to prevent the spread of infection to protect patients, yourself and other health workers (1).

The rationale for implementing standard IPC precautions for the care of all patients at all times is as follows:

- A patient may show no signs or symptoms of infection at the time of consultation or treatment, but she may be infectious as she may be incubating an infectious disease.
- A patient may be an asymptomatic carrier of a blood-borne virus (i.e. HIV, hepatitis B, C and D) and/or other virus, or may be colonized with multidrug-resistant microorganisms.

Immunization: As an integral part of the application of standard IPC precautions, health workers should be immunized against vaccine-preventable diseases both for their own protection and for the protection of patients and other health workers.

Education and training: Health workers and other relevant personnel must be given adequate education and practical training in IPC. The IPC education programme should be part of an induction programme for all new members of staff. All staff should also receive regular refresher training to keep them up to date on new areas of knowledge and work practices; this is especially important if new equipment and/or procedures are introduced.

Hand hygiene: Hand hygiene is essential to prevent cross infection, so adequate hand hygiene facilities (e.g. alcohol-based handrub [ABHRs] products) must be available and the practice must be performed as indicated in the *WHO guidelines on hand hygiene in health care* (2), as follows:

1. Before touching a patient
2. Before a clean/aseptic procedure
3. After body fluid exposure risk
4. After touching a patient
5. After touching patient surroundings.

In addition, hands must be decontaminated immediately before and after wearing gloves, as gloves are not a substitute for hand hygiene.

ABHRs are more effective in decontaminating hands than hand washing with soap and water. However, ABHR can only be applied on physically clean hands. If the hands are visibly dirty and/or contaminated with blood and/or body fluids, then they must be washed thoroughly with soap and water and dried on a clean paper towel or single-use clean cloth towel. The recommended duration for performing hand hygiene is 40–60 seconds for hand washing with soap and water, and 20–40 seconds if an ABHR product is used.

Personal protective equipment (PPE): It is the responsibility of employers to ensure that appropriate items of PPE (i.e. gloves, aprons, gowns, masks, eye shields, etc.) are available.

Sterile and non-sterile gloves are usually made of latex material. For health workers or patients who have a history of latex allergy, non-latex must be used to prevent anaphylactic reactions.

Sterile gloves are used to prevent transfer of microorganisms from health workers to patients during procedures requiring asepsis. In addition, they also provide protection for the health worker against pathogens present in blood and/or body fluids they are exposed to during surgical and invasive procedures. They must be used for all surgical and aseptic procedures.

Non-sterile gloves are used to protect health workers from acquiring microorganisms or contracting infections from patients or contaminated environments. They should be used whenever there is potential for touching blood and/or body fluids, secretions, excretions or potential for contact with infectious and dangerous microorganisms, both from direct and indirect contact with patients and items/equipment in the environment.

If the gloves are damaged or punctured during a procedure, it is essential that they should be removed immediately and the hand should be washed thoroughly and a new glove should be donned. Remember that use of gloves is not a substitute for hand hygiene.

Based on the type of procedure and risk assessment, the appropriate types of gloves should be used when performing clinical examinations or procedures, such as cryotherapy, cervical biopsy, endocervical curettage and loop electrosurgical excision procedure (LEEP).

Other items of PPE (i.e. aprons, gowns, masks, eye shields) should be used appropriately based on the risk assessment of the procedure.

Handling and disposal of contaminated waste: Contaminated waste poses a hazard and therefore it is essential that all the clinical waste, including sharps, must be disposed of properly, in accordance with local guidelines and regulations.

It is essential to:

- Dispose of all disposable items that are soiled with blood and/or body fluids as clinical waste, in a tightly sealed plastic bag or in approved containers, in accordance with local guidelines.
- Handle all sharps carefully and dispose of all contaminated sharps, needles and syringes in rigid leak- and puncture-proof containers; they must be disposed of in accordance with local guidelines.

After treatment of each patient, the area should be thoroughly cleaned and other items/equipment should be thoroughly cleaned and decontaminated in accordance with protocols. At the end of the session, the room should be thoroughly cleaned, and disinfection of surfaces touched by hands is also required.

Processing of reusable instruments: All instruments that have been in contact with the vagina or cervix (e.g. vaginal specula, biopsy forceps, cryoprobes, cryosurgical equipment) must be thoroughly cleaned prior to decontamination using sterilization or high-level disinfection, in accordance with the manufacturer's instructions.

The procedure for decontamination of individual items and equipment is beyond the scope of this document; readers are advised to refer to the PAHO *Sterilization manual for health centers*, which is currently being updated (3).

References

1. Siegel JD, Rhinehart E, Jackson M, Chiarello L; Healthcare Infection Control Practices Advisory Committee. 2007 Guideline for isolation precautions: preventing transmission of infectious agents in health care settings. *Am J Infect Control*. 2007;35(10 Suppl 2);S65–S164. doi:10.1016/j.ajic.2007.10.007.
2. WHO guidelines on hand hygiene in health care. Geneva: World Health Organization; 2009 (http://whqlibdoc.who.int/publications/2009/9789241597906_eng.pdf, accessed 16 July 2014).
3. Acosta-Gnass SI, de Andrade Stempliuk V. *Sterilization manual for health centers*. Washington (DC): Pan American Health Organization; 2009 (http://www.paho.org/PAHO-USAID/dmdocuments/AMR-Sterilization_Manual_Health_Centers_2009.pdf, accessed 26 May 2014).²

² Currently being updated under a new title: *Decontamination and reprocessing manual for healthcare facilities*.

Annex 4. Cancer and pre-cancer classification systems

There are many systems in use in different parts of the world for classifying and naming precancerous conditions of the cervix, based on cytology and histology (see table below). The more useful classification systems incorporate information about the disease's natural history, which has been acquired over the past few decades.

The cervical intraepithelial neoplasia (CIN) classification system evolved in 1968, to take into account the different natural histories seen with different degrees of dysplasia (ranging from CIN1/mild, to CIN2/moderate, and CIN3/severe dysplasia). The CIN classification is still used in many countries for cytological reports, although strictly speaking it should only be used for histological reports (i.e. results of microscopic examination of tissue samples).

The Bethesda System was developed in the 1990s at the United States National Cancer Institute. In this system, which should be used only for cytological reports (i.e. results of microscopic examination of a smear), CIN2 and CIN3 are combined into one group, termed high-grade squamous intraepithelial lesions (HSIL), because cytologically it is difficult, if not impossible, to distinguish CIN2 from CIN3. Meanwhile, CIN1 results are termed low-grade squamous intraepithelial lesions (LSIL). In the 2001 Bethesda System, atypical cells are divided into ASCUS (atypical squamous cells of undetermined significance) and ASC-H (atypical squamous cells: cannot exclude a high-grade squamous intraepithelial lesion). This classification is recommended by WHO for cytological reports (see Annex 5).



Bethesda System

Table: Cervical pre-cancer: terminology for cytological and histological reporting

Cytological classification (used for screening)		Histological classification (used for diagnosis)	
Pap	Bethesda System	CIN	WHO descriptive classifications
Class I	Normal	Normal	Normal
Class II	ASCUS ASC-H	Atypia	Atypia
Class III	LSIL	CIN1 including flat condyloma	Koilocytosis
Class III	HSIL	CIN2	Moderate dysplasia
Class III	HSIL	CIN3	Severe dysplasia
Class IV	HSIL	CIN3	Carcinoma in situ
Class V	Invasive carcinoma	Invasive carcinoma	Invasive carcinoma

ASC-H: atypical squamous cells: cannot exclude a high-grade squamous (intra)epithelial lesion; ASCUS: atypical squamous cells of undetermined significance; CIN: cervical intraepithelial neoplasia; HSIL: high-grade squamous intraepithelial lesion; LSIL: low-grade squamous intraepithelial lesion.

The International Classification of Diseases (ICD) is the international standard for coding causes of illness and death. In its current 10th revision it is used in some 110 countries.

The ICD coding scheme for cervical dysplasias and neoplasias follows the WHO scheme as shown in the right-hand column of the table. References to both CIN and HSIL/LSIL are included in the ICD.³ For cancer registration and in order to describe the tissue changes in more detail (histopathology), an adaptation of the ICD has been formulated: the ICD for Oncology (ICD-O). It contains detailed codes for the site of the neoplasia, and an additional set of codes for the histopathology.⁴

The ICD-O classification of the neoplastic tissue types, based on histopathology or tumour morphology, is informed by the work of the International Agency for Research on Cancer (IARC), which is regularly published in the WHO/IARC Classification of Tumours series.⁵ For cervical tumours and dysplasias, the fourth edition of *WHO classification of tumours of female reproductive organs* was published at the end of March 2014.⁶

The clinical path for treatment and the prognosis depend on the histopathology and the extent of the spread, or stage, of cancer. **The Union for International Cancer Control (UICC) TNM classification of malignant tumours** is a system based on description of the spread and size of the cancer. It documents the size of the tumour (T), affected lymph nodes (N) and distant metastases (M). The TNM stages are based either on clinical description or on pathological classification (pTNM).⁷ The TNM classification system is compatible with the clinical classification that is produced by the International Federation of Gynecology and Obstetrics (FIGO)⁸ (see Chapter 6, section 6.3).

³ Available at: <http://www.who.int/classifications/icd>

⁴ Available at: <http://codes.pubcan.org>

⁵ Available at: <http://www.iarc.fr/en/publications/list/bb/index.php>

⁶ Kurman RJ, Carcangiu ML, Herrington S, Young RH, editors. WHO classification of tumours of female reproductive organs, volume 6 (4th edition). Lyon: International Agency for Research on Cancer; 2014.

⁷ Available at: <http://www.uicc.org/resources/tnm>

⁸ Available at: <http://www.figo.org/publications/annual>

Annex 5. The 2001 Bethesda System⁹

Specimen adequacy

- Satisfactory for evaluation (note presence or absence of endocervical transformation zone component);
- Unsatisfactory for evaluation (specify reason);
- Specimen rejected/not processed (specify reason);
- Specimen processed and examined, but unsatisfactory for evaluation of epithelial abnormality (specify reason).

General categorization (optional)

1. Negative for intraepithelial lesion or malignancy
2. Epithelial cell abnormality
3. Other.

Interpretation and result

1. Negative for intraepithelial lesion or malignancy

Organisms:

- *Trichomonas vaginalis*
- fungal organisms morphologically consistent with *Candida* species
- shift in flora suggestive of bacterial vaginosis
- bacteria morphologically consistent with *Actinomyces* species
- cellular changes consistent with herpes simplex virus.

Other non-neoplastic findings (optional to report, list not comprehensive):

- reactive cellular changes associated with inflammation (includes typical repair)
- radiation
- intrauterine contraceptive device
- glandular cells status post-hysterectomy
- atrophy.

⁹ This categorization can be used for reporting results of Pap smears.

Source: Solomon D, Davey D, Kurman R, Moriarty A, O'Connor D, Prey M, et al.; Forum Group Members; Bethesda 2001 Workshop. The 2001 Bethesda System: terminology for reporting results of cervical cytology. JAMA. 2002;287(16):2114–9.

2. Epithelial cell abnormalities

Squamous cells:

- atypical squamous cell (ASC)
 - of undetermined significance (ASCUS)
 - cannot exclude high-grade lesion (ASC-H)
- low-grade squamous intraepithelial lesion (LSIL)
- high-grade squamous intraepithelial lesion (HSIL)
- squamous cell carcinoma.

Glandular cells:

- atypical glandular cells (AGC) (specify endocervical, endometrial, or not specified)
- atypical glandular cells, favour neoplastic (specify endocervical or not specified)
- endocervical adenocarcinoma in situ (AIS)
- adenocarcinoma.

3. Other (list not comprehensive)

- Endometrial cells in women 40 years of age or over.

Annex 6. HPV immunization sample forms

Sample Form 6.1: Girl's personal HPV vaccination card

The vaccination card is to be maintained by the girl – other vaccinations may be added.

The card heading can contain the following fields:

- Name of the girl
- Date of birth
- Unique identification number
- Contact details
- Site where vaccination takes place: District and health-care facility or school (or other off-site location).

Vaccine (brand name)	Date dose received (DD/MM/YYYY)	Return date for next dose (DD/MM/YYYY)	Observations (e.g. side-effects, allergic reactions or other notes)
HPV1			
HPV2			
HPV3 (if required)			
Other vaccines			

The card may also contain appropriate messages about HPV vaccination (e.g. required number of doses) and relevant health education messages tailored to the age group about other preventive health interventions, such as:

Primary prevention:

- Sexual health education
- Contraceptive counselling and services, including condoms
- Tobacco use prevention and cessation support
- Physical activity
- Nutrition

Secondary prevention:

- Cervical cancer screening later in life.

Sample Form 6.2: HPV vaccine coverage monitoring forms for vaccine providers at the service delivery site level¹⁰

A6

Annex 6. HPV immunization sample forms

1. The HPV vaccine service provider logbook

Instructions:

- Use one logbook per service delivery site (Table 1).
- Register each girl by recording her name, address, date of birth, date of HPV1 or HPV2,¹¹ and age when each dose is given (enter the age as reported by the girl or her mother).¹²
- When a girl returns for HPV2, her personal immunization card should be used to locate her place in the logbook and to verify the need for HPV2.

Table 1: HPV vaccine service provider logbook

District: _____							
Town/village: _____							
Service delivery site: _____							
Name	Address	DOB (DD/MM/ YYYY)	HPV1		HPV2		Comments
			Date given (DD/MM/ YYYY)	Age of girl (years)	Date given (DD/MM/ YYYY)	Age of girl (years)	

2. Tally Sheet to record the number of HPV doses given on a single vaccination day

Instructions: Tallying the number of HPV doses given, by dose number (i.e. HPV1, HPV2 and HPV3) and by age:

- Fill out one Tally Sheet per vaccination day.
- When registering each girl, strike one zero on the Tally Sheet according to the HPV dose number given and her age.

¹⁰ Source: WHO HPV vaccination coverage monitoring guide and tool (available at: <http://www.who.int/immunization/diseases/hpv/resources/en/>)

¹¹ HPV1 and HPV2: The numbers indicate the first and second doses given in the HPV vaccine series.

¹² The logbook should include both date of birth and reported age at each vaccine dose given. For a girl whose date of birth and age is unknown, the vaccine provider should make an informed guess to indicate her age, otherwise the information will be lost in coverage calculations.

- At the end of each vaccination day, calculate the sub-totals of HPV doses given, by dose number and by age:
 - Count and record the number of strike-throughs made in each HPV dose number per age category.
 - For sub-totals of 0, do not leave blank but clearly record the number 0 with a strike-through.

Table 2: Tally Sheet to record the number of HPV doses given on a single vaccination day

Date of vaccination (DD/MM/YYYY): _/_/	District: _____						
	Town/village: _____						
Service delivery site: _____							
Age (years)	Number of HPV1 doses given		Number of HPV2 doses given		OPTIONAL CHECK COLUMN (sum up rows)		
9	0000 0000 0000 0000	0000 0000 0000 0000	9yrHPV1=	0000 0000 0000 0000	0000 0000 0000 0000	9yrHPV2=	=
10	0000 0000 0000 0000	0000 0000 0000 0000	10yrHPV1=	0000 0000 0000 0000	0000 0000 0000 0000	10yrHPV2=	=
11	0000 0000 0000 0000	0000 0000 0000 0000	11yrHPV1=	0000 0000 0000 0000	0000 0000 0000 0000	11yrHPV2=	=
12	0000 0000 0000 0000	0000 0000 0000 0000	12yrHPV1=	0000 0000 0000 0000	0000 0000 0000 0000	12yrHPV2=	=
13	0000 0000 0000 0000	0000 0000 0000 0000	13yrHPV1=	0000 0000 0000 0000	0000 0000 0000 0000	13yrHPV2=	=
14	0000 0000 0000 0000	0000 0000 0000 0000	14yrHPV1=	0000 0000 0000 0000	0000 0000 0000 0000	14yrHPV2=	=
≥ 15	0000 0000 0000 0000	0000 0000 0000 0000	15yrHPV1=	0000 0000 0000 0000	0000 0000 0000 0000	15yrHPV2=	=
Unknown	0000 0000 0000 0000	0000 0000 0000 0000	UknHPV1=	0000 0000 0000 0000	0000 0000 0000 0000	UknHPV2=	=
OPTIONAL CHECK ROW (sum up columns)	0000 0000 0000 0000	0000 0000 0000 0000		0000 0000 0000 0000	0000 0000 0000 0000		Grand total =

Sample Form 6.3: Reporting of national HPV vaccine coverage for the WHO–UNICEF joint reporting form¹³

Table instructions: Report the number of HPV vaccinations given to females by their age at time of administration for each of the recommended doses of HPV vaccine. If age is unknown but can be estimated, report for the estimated age. For example, if vaccination is offered exclusively to girls in the 6th school class/year/grade, when most girls are 11 years old, vaccinations by dose may be reported as vaccinations for girls aged 11 years.

HPV vaccine doses administered:

Females			
Vaccine administered (age in years)	1st dose	2nd dose	3rd dose
9			
10			
11			
12			
13			
14			
15+			
unknown age			

¹³ More information and resources are available at the WHO webpage, *Immunization surveillance, assessment and monitoring* (http://www.who.int/immunization/monitoring_surveillance/en/).

Sample Form 6.4: Reporting of adverse events following immunization (AEFIs)

This form is to be completed by the health worker and returned to the immunization programme manager or appropriate local health authority (or other procedure, in accordance with the established reporting system in the country).

Demographic details

Family name:				First name:		Identification number:	
Address:				Date of birth: (DD/MM/YY) ____/____/____ or, Age: ____ years ____ months			
Region:		District:		Sex: ____ Male ____ Female			
Health facility (or vaccination centre):				Reporter (health worker):			
Vaccine(s) given*	Route	Site of injection	Lot number of vaccine	Lot number of diluent	Manufacturer**	Expiry date of vaccine	Expiry date of diluent

* If event follows routine vaccination, give name and dose number, e.g. measles1, DPT-2, OPV-2.

** Include information for diluent if applicable.

Description of AEFIs

Date vaccinated	Date AEFI started	Onset interval	Date of report
Tick box(es) and describe event(s):			
<input type="checkbox"/> Severe local reaction: > 3 days <input type="checkbox"/> beyond nearest joint <input type="checkbox"/> hospitalized <input type="checkbox"/> <input type="checkbox"/> Abscess: sterile <input type="checkbox"/> bacterial <input type="checkbox"/> <input type="checkbox"/> Sepsis <input type="checkbox"/> Toxic shock syndrome		<input type="checkbox"/> Anaphylactic reaction <input type="checkbox"/> Anaphylaxis <input type="checkbox"/> Seizures, including febrile seizures <input type="checkbox"/> Encephalopathy <input type="checkbox"/> Thrombocytopenia	
<input type="checkbox"/> Other AEFI (describe). Use additional sheet if needed.			
Outcome:			
<input type="checkbox"/> Recovered fully		<input type="checkbox"/> Recovered partially <input type="checkbox"/> Unknown	
<input type="checkbox"/> Hospitalized:		Date of admission (DD/MM/YY) ____/____/____ Date of discharge (DD/MM/YY) ____/____/____	
<input type="checkbox"/> Died:		Date of death (DD/MM/YY) ____/____/____	
Past medical history (including history of similar reaction or other allergies) and any other relevant information (e.g. other cases). Use additional sheet if needed.			

Province-level or district office to complete

Date report received: (DD/MM/YY) ____/____/____	Checked by:
Investigation needed? ____ Yes ____ No	If yes, date investigation started: (DD/MM/YY) ____/____/____
Investigator:	AEFI Investigation ID:
Causality assessment:	Certainty:

A6

Annex 6. HPV immunization sample forms

Annex 7. Decision-making flowchart for screen-and-treat strategies

This decision-making flowchart or algorithm provides a decision tree to use as a quick reference when choosing a screen-and-treat strategy at the programme level. Programme managers and decision-makers can start at the top and answer the questions accordingly to determine which screen-and-treat option is best in the context where it will be implemented. It highlights choices related to resources, which can include costs, staff and training. However, programme managers will also need to consider other factors, such as the number of women who are lost to follow-up with a strategy that involves more than one screening test. Refer to the screen-and-treat recommendations provided in Chapter 3 of the *WHO guidelines for screening and treatment of precancerous lesions for cervical cancer prevention (2013)*¹⁴ for more specific guidance about which strategies are recommended, and for information on the specific factors to consider when deciding on a strategy. For details about the flow of each screen-and-treat strategy (e.g. HPV followed by VIA), consult the flowcharts in Annex 8 (for women of negative or unknown HIV status) and Annex 9 (for women of HIV-positive status or unknown HIV status in areas with high endemic HIV infection).

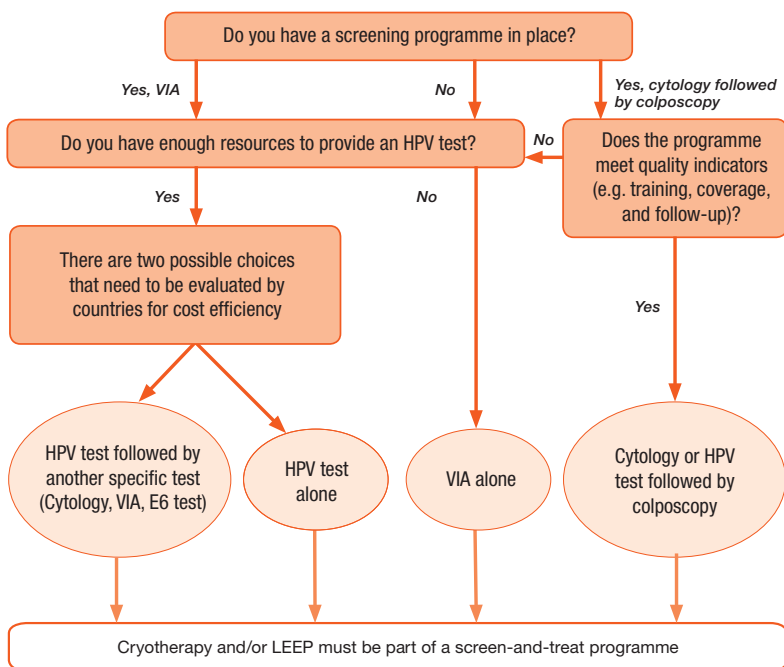

Note: Each light-pink bubble refers to one strategy in Annex 8 (for women of negative or unknown HIV status) or Annex 9 (for women of HIV-positive status or unknown HIV status in areas with high endemic HIV infection).

¹⁴ Available at: http://www.who.int/reproductivehealth/publications/cancers/screening_and_treatment_of_precancerous_lesions/en/

Annex 8. Flowcharts for screen-and-treat strategies (negative or unknown HIV status)

The following flowcharts describe the steps for each of the screen-and-treat strategies that are available. The flowcharts do not indicate which strategy is preferred. Refer to the screen-and-treat recommendations provided in Chapter 3 of the *WHO guidelines for screening and treatment of precancerous lesions for cervical cancer prevention (2013)*¹⁵ for guidance about which strategies are recommended, and to the decision-making flowchart in Annex 7. For detailed information about the specific factors the guideline panel considered when making the recommendations, refer to the evidence-to-recommendation tables for each recommendation presented in that guidance (Supplemental material, Sections A and B).



Screen with an HPV test and treat with cryotherapy, or LEEP when not eligible for cryotherapy

When an HPV test is positive, treatment is provided. With this strategy, visual inspection with acetic acid (VIA) is used to determine **eligibility** for cryotherapy.

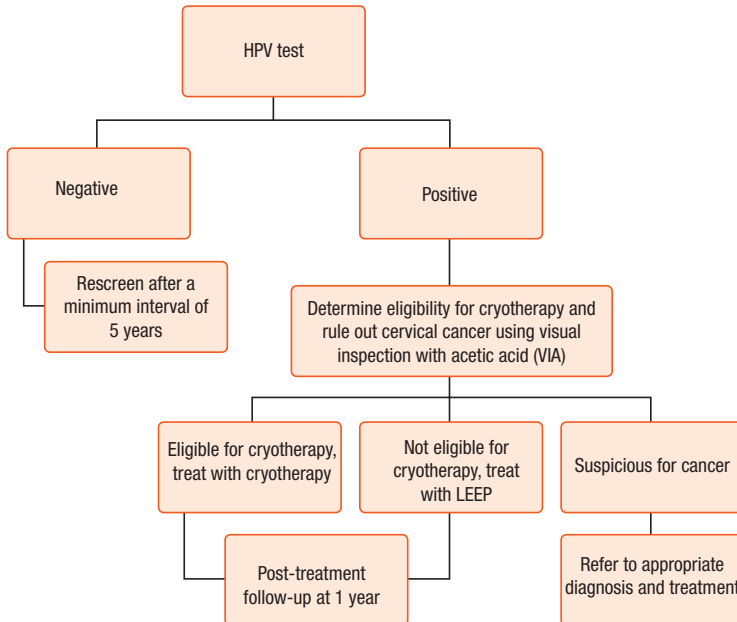

Note: Refer to the screen-and-treat recommendations provided in Chapter 3 of the *WHO guidelines for screening and treatment of precancerous lesions for cervical cancer prevention (2013)* for guidance about which strategies are recommended, and for information on the specific factors to consider when deciding on a strategy.

¹⁵ The guidelines and the supplemental material are available at: http://www.who.int/reproductivehealth/publications/cancers/screening_and_treatment_of_precancerous_lesions/en/

Screen with an HPV test followed by VIA and treat with cryotherapy, or LEEP when not eligible for cryotherapy

When an HPV test is positive, then VIA is provided as a second screening test to determine whether or not treatment is offered. Treatment is only provided if BOTH the HPV test and VIA are positive.

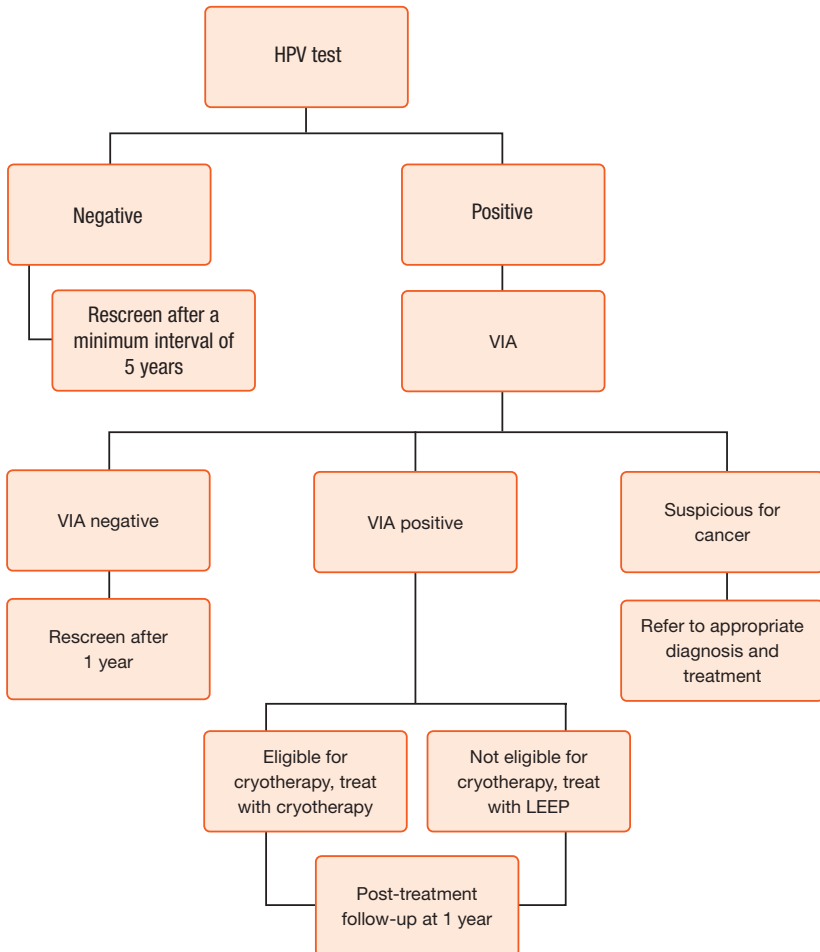

Note: Refer to the screen-and-treat recommendations provided in Chapter 3 of the *WHO guidelines for screening and treatment of precancerous lesions for cervical cancer prevention* (2013) for guidance about which strategies are recommended, and for information on the specific factors to consider when deciding on a strategy.¹⁶

¹⁶ The guidelines and the supplemental material are available at: http://www.who.int/reproductivehealth/publications/cancers/screening_and_treatment_of_precancerous_lesions/en/

Screen with VIA and treat with cryotherapy, or LEEP when not eligible for cryotherapy

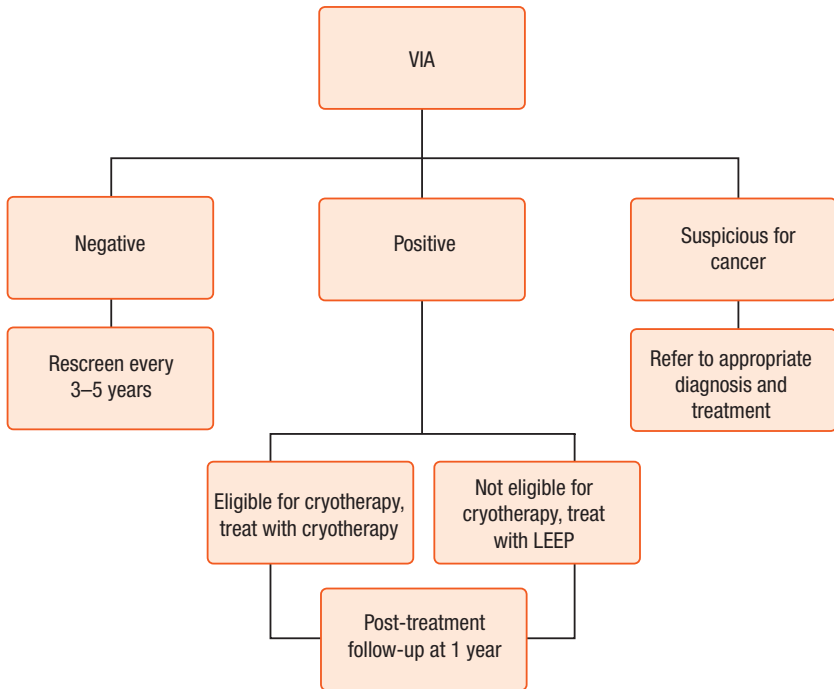

Note: Refer to the screen-and-treat recommendations provided in Chapter 3 of the *WHO guidelines for screening and treatment of precancerous lesions for cervical cancer prevention* (2013) for guidance about which strategies are recommended, and for information on the specific factors to consider when deciding on a strategy.¹⁷

¹⁷ The guidelines and the supplemental material are available at: http://www.who.int/reproductivehealth/publications/cancers/screening_and_treatment_of_precancerous_lesions/en/

Screen with an HPV test followed by colposcopy (with or without biopsy)¹⁸ and treat with cryotherapy, or LEEP when not eligible for cryotherapy

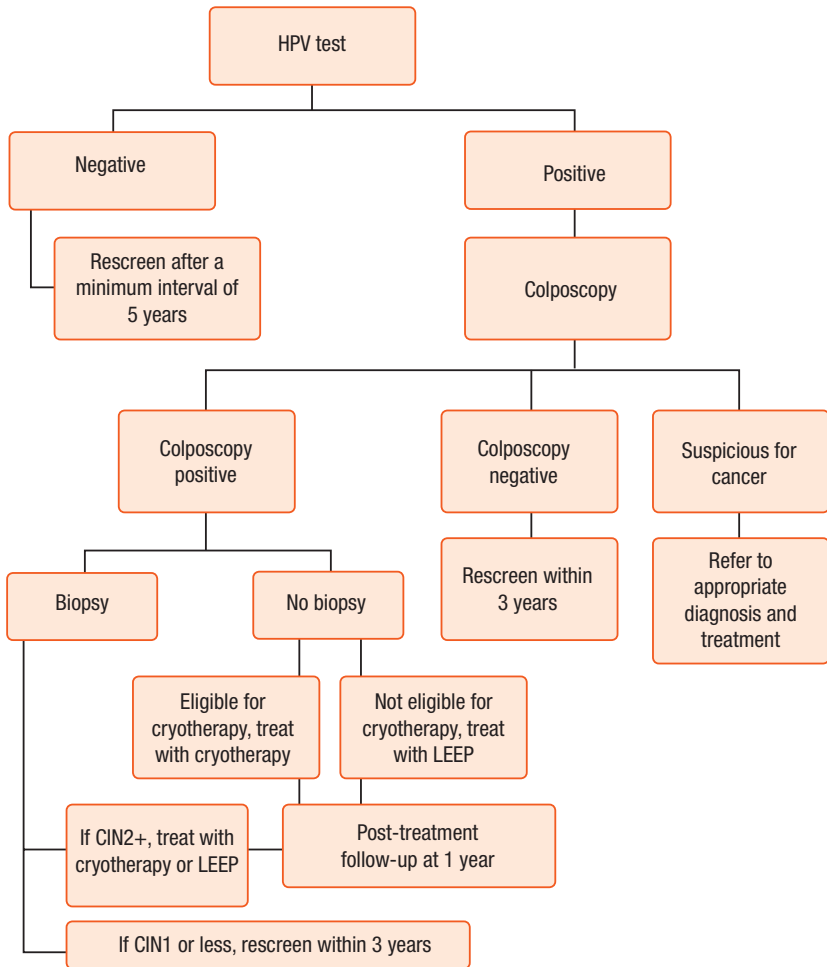

Note: Refer to the screen-and-treat recommendations provided in Chapter 3 of the *WHO guidelines for screening and treatment of precancerous lesions for cervical cancer prevention* (2013) for guidance about which strategies are recommended, and for information on the specific factors to consider when deciding on a strategy.¹⁹

¹⁸ Women with positive colposcopic impression can receive biopsy for histological confirmation or be immediately treated.

¹⁹ The guidelines and the supplemental material are available at: http://www.who.int/reproductivehealth/publications/cancers/screening_and_treatment_of_precancerous_lesions/en/

Screen with cytology followed by colposcopy (with or without biopsy)²⁰ and treat with cryotherapy, or LEEP when not eligible for cryotherapy

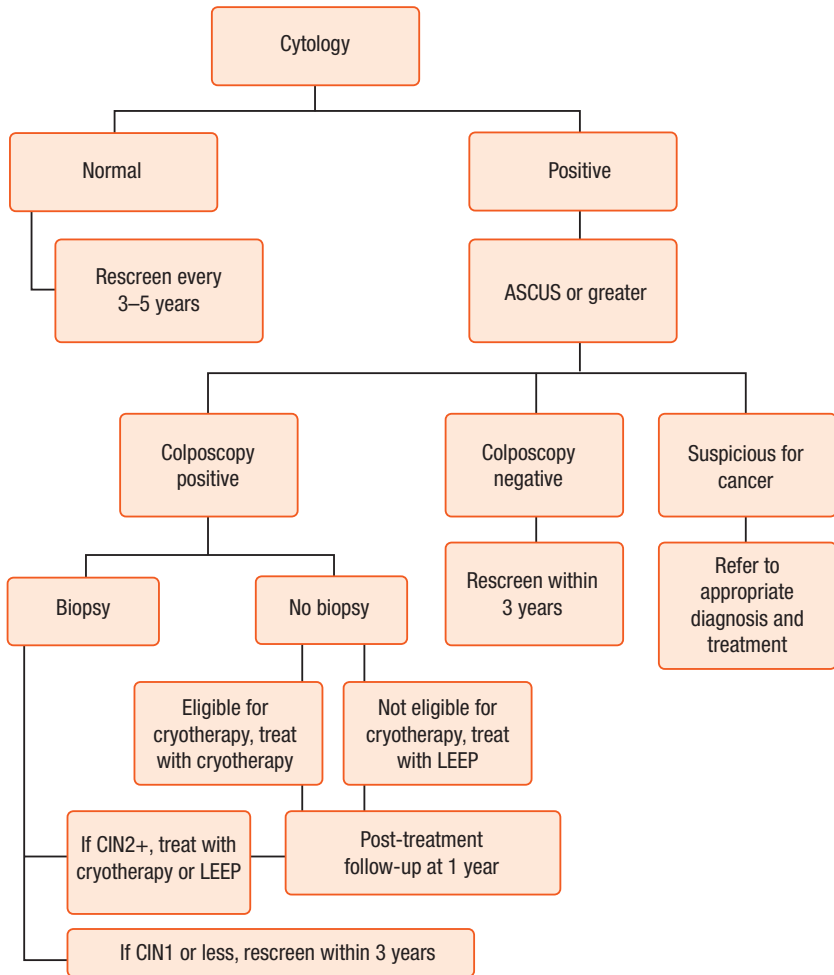

Note: Refer to the screen-and-treat recommendations provided in Chapter 3 of the *WHO guidelines for screening and treatment of precancerous lesions for cervical cancer prevention* (2013) for guidance about which strategies are recommended, and for information on the specific factors to consider when deciding on a strategy.²¹

²⁰ Women with positive colposcopic impression can receive biopsy for histological confirmation or be immediately treated.

²¹ The guidelines and the supplemental material are available at: http://www.who.int/reproductivehealth/publications/cancers/screening_and_treatment_of_precancerous_lesions/en/

Annex 9. Flowcharts for screen-and-treat strategies (HIV-positive status or unknown HIV status in areas with high endemic HIV infection)

The following flowcharts describe the steps for each of the screen-and-treat strategies that are available. The flowcharts do not indicate which strategy is preferred. Refer to the screen-and-treat recommendations provided in Chapter 3 of *WHO guidelines for screening and treatment of precancerous lesions for cervical cancer prevention (2013)*²² for guidance about which strategies are recommended, and to the decision-making flowchart in Annex 7. For detailed information about the specific factors the guideline panel considered when making the recommendations, refer to the evidence-to-recommendation tables for each recommendation presented in that guidance (Supplemental material, Sections A and B).

Screen with an HPV test and treat with cryotherapy, or LEEP when not eligible for cryotherapy

When an HPV test is positive, treatment is provided. With this strategy, visual inspection with acetic acid (VIA) is used to determine **eligibility** for cryotherapy.

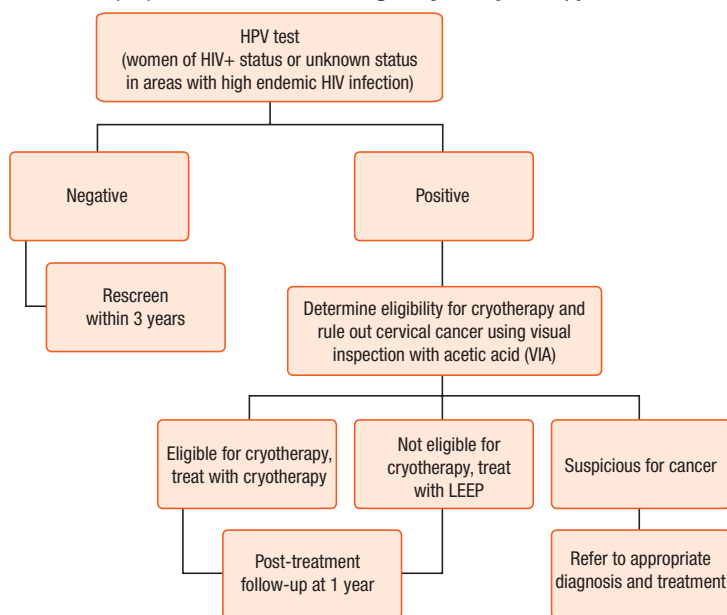

Note: Refer to the screen-and-treat recommendations provided in Chapter 3 of the *WHO guidelines for screening and treatment of precancerous lesions for cervical cancer prevention (2013)* for guidance about which strategies are recommended, and for information on the factors to consider when deciding on a strategy.

²² The guidelines and the supplemental material are available at: http://www.who.int/reproductivehealth/publications/cancers/screening_and_treatment_of_precancerous_lesions/en/index.html

Screen with an HPV test followed by VIA and treat with cryotherapy, or LEEP when not eligible for cryotherapy

When an HPV test is positive, then VIA is provided as a second screening test to determine whether or not treatment is offered. Treatment is only provided if BOTH the HPV test and VIA are positive.

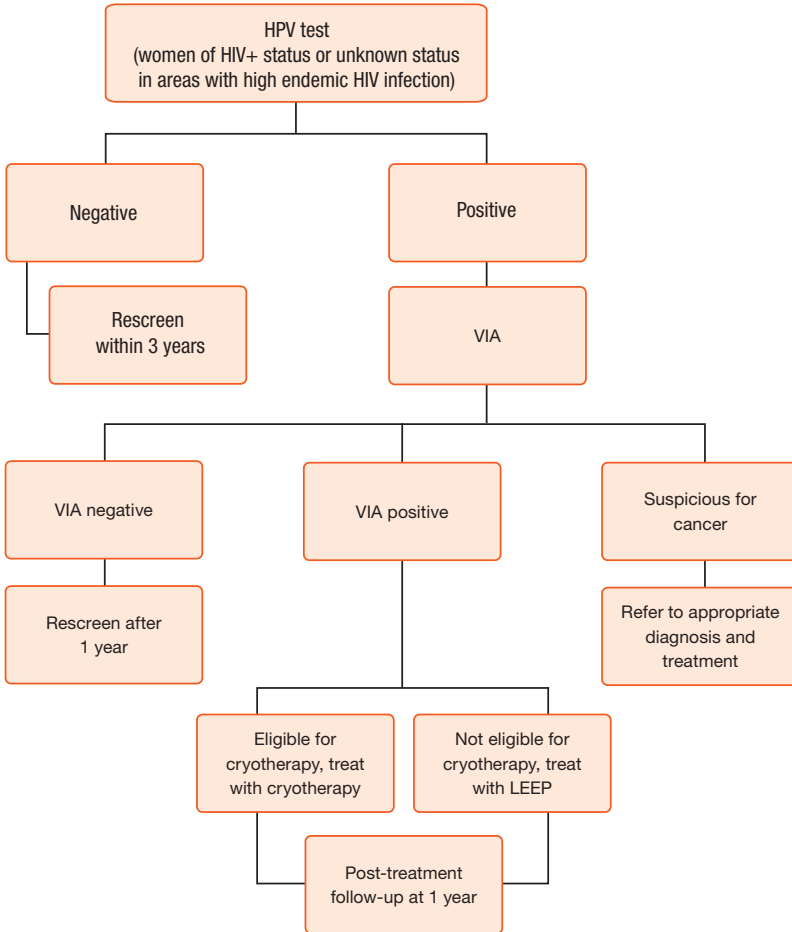

Note: Refer to the screen-and-treat recommendations provided in Chapter 3 of the *WHO guidelines for screening and treatment of precancerous lesions for cervical cancer prevention* (2013) for guidance about which strategies are recommended, and for information on the specific factors to consider when deciding on a strategy.²³

²³ The guidelines and the supplemental material are available at: http://www.who.int/reproductivehealth/publications/cancers/screening_and_treatment_of_precancerous_lesions/en/index.html

Screen with VIA and treat with cryotherapy, or LEEP when not eligible for cryotherapy

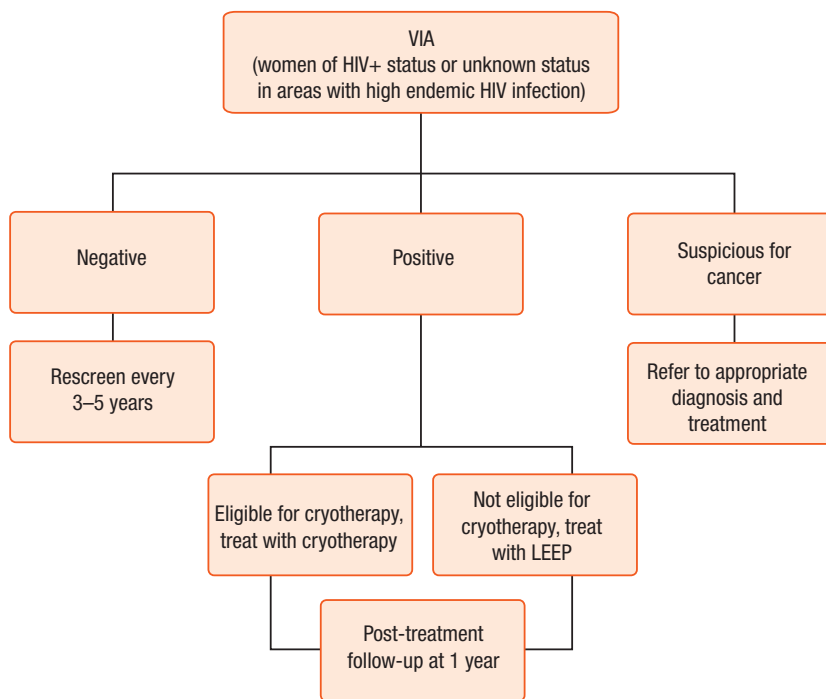

Note: Refer to the screen-and-treat recommendations provided in Chapter 3 of the *WHO guidelines for screening and treatment of precancerous lesions for cervical cancer prevention* (2013) for guidance about which strategies are recommended, and for information on the factors to consider when deciding on a strategy.²⁴

²⁴ The guidelines and the supplemental material are available at: http://www.who.int/reproductive-health/publications/cancers/screening_and_treatment_of_precancerous_lesions/en/index.html

Screen with an HPV test followed by colposcopy (with or without biopsy)²⁵ and treat with cryotherapy, or LEEP when not eligible for cryotherapy

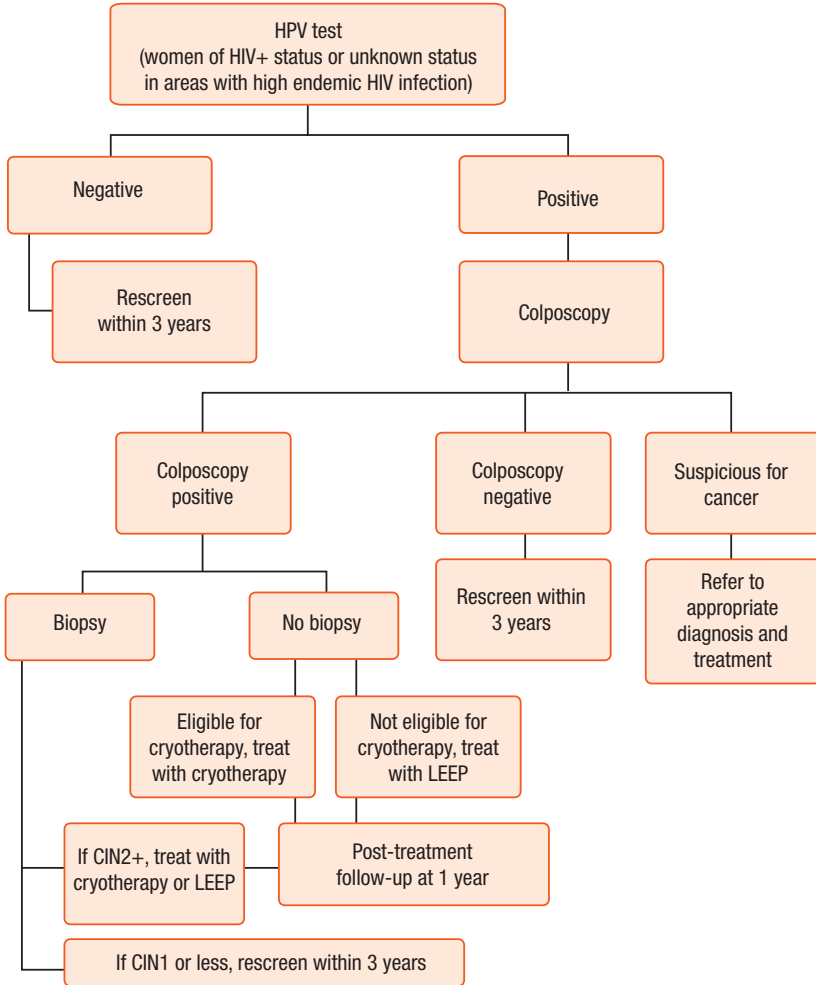

Note: Refer to the screen-and-treat recommendations provided in Chapter 3 of the WHO guidelines for screening and treatment of precancerous lesions for cervical cancer prevention (2013) for guidance about which strategies are recommended, and for information on the factors to consider when deciding on a strategy.²⁶

²⁵ Women with positive colposcopic impression can receive biopsy for histological confirmation or be treated immediately.

²⁶ The guidelines and the supplemental material are available at: http://www.who.int/reproductivehealth/publications/cancers/screening_and_treatment_of_precancerous_lesions/en/index.html

Screen with cytology followed by colposcopy (with or without biopsy)²⁷ and treat with cryotherapy or LEEP (when not eligible for cryotherapy)

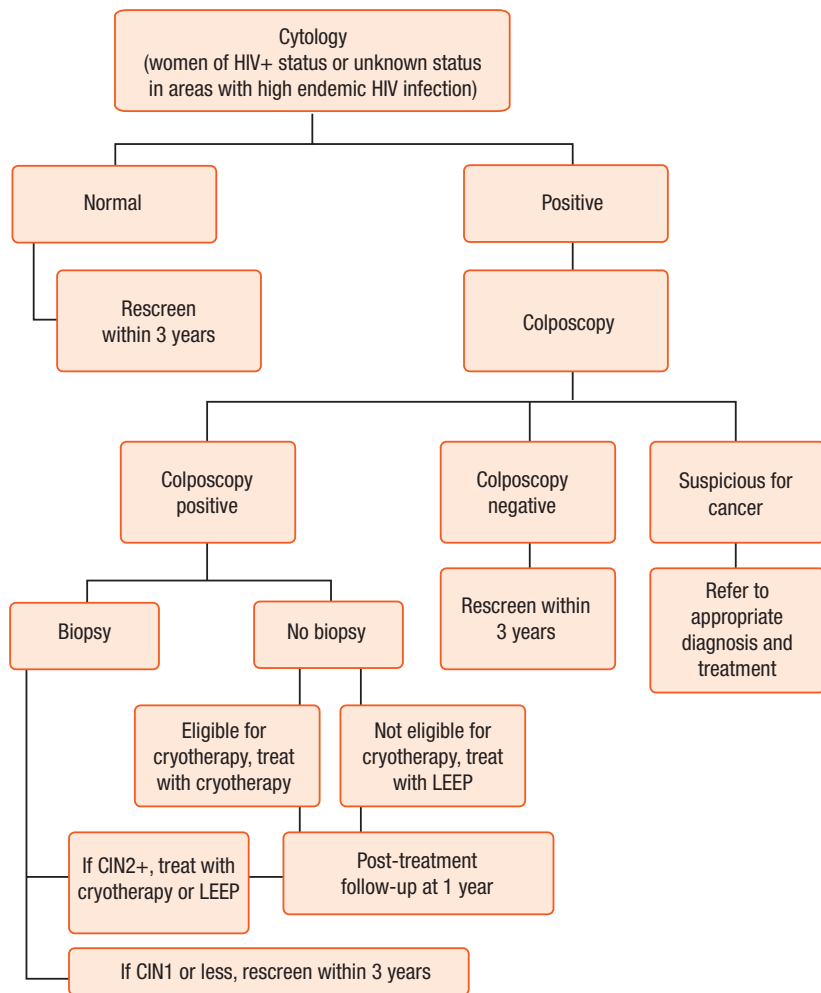

Note: Refer to the screen-and-treat recommendations provided in Chapter 3 of the *WHO guidelines for screening and treatment of precancerous lesions for cervical cancer prevention (2013)* for guidance about which strategies are recommended, and for information on the factors to consider when deciding on a strategy.²⁸

²⁷ Women with positive colposcopic impression can receive biopsy for histological confirmation or be treated immediately.

²⁸ The guidelines and the supplemental material are available at: http://www.who.int/reproductivehealth/publications/cancers/screening_and_treatment_of_precancerous_lesions/en/index.html

Annex 10. Cervical cancer treatment by FIGO stage

General considerations for cervical cancer treatment by stage:

By FIGO stage	Patient characteristics	Options to consider	Comments or potential complications
Note: FIGO staging is based on clinical examination.	Visible lesions require biopsy to confirm diagnosis. Blood counts, including a complete blood count, renal, liver function, and HIV or syphilis serology, may be considered.	Palpation, inspection, colposcopy, endocervical curettings, hysteroscopy, cystoscopy, proctoscopy, intravenous pyelography and X-ray examination of lungs and skeleton are permitted for staging.	CT, MRI and/or PET may be used.
IA1/IA2: Cancer is strictly confined to the cervix. A1: ≤ 3 mm depth; < 7 mm width A2: > 3 mm but ≤ 5 mm depth; < 7 mm width	No gross lesion seen: A1: desires fertility A1: fertility not a factor A2: desires fertility A2: fertility not a factor	Cervical cone biopsy to determine depth and width A1: cone with negative margins and close follow-up Hysterectomy after childbearing complete A1: hysterectomy A2: large cone with negative margins or radical trachelectomy with node evaluation A2: modified radical hysterectomy and node dissection	Cone biopsies and radical trachelectomy may increase risk for prematurity if fertility is desired. When childbearing is complete, then hysterectomy or modified radical hysterectomy for final therapy is considered.
IB: Cancer is clinically confined to the cervix, or preclinical lesion greater than A2. IB1: ≤ 4 cm IB2: > 4 cm	Tumours < 2 cm with $< 50\%$ cervical invasion may be considered for less radical (modified radical hysterectomy) with expert consultation.	Radiotherapy with concurrent chemotherapy Radical hysterectomy and pelvic lymph node dissection	Ureteral fistula rate is small and similar between the two modes of therapy. Radiation causes ovarian failure in premenopausal women.

A10

Annex 10. Cervical cancer treatment by FIGO stage

By FIGO stage	Patient characteristics	Options to consider	Comments or potential complications
<p>II: Cancer extends beyond the uterus, but not to the pelvic wall or lower third of the vagina.</p> <p>IIA: upper two thirds of the vagina, no parametrial involvement</p> <p>IIB: parametrial involvement</p>	<p>IIA cancers with limited extension into the upper vagina may be candidates for radical hysterectomy and pelvic lymph node dissection with expert consultation.</p>	<p>Radiation with concurrent chemotherapy is the primary mode of treatment.</p>	<p>Bladder and bowel short- and long-term side-effects of radiation.</p>
<p>III: Cancer extends onto the sidewall or lower third of the vagina.</p> <p>IIIA: lower third of the vagina</p> <p>IIIB: the sidewall</p>	<p>All patients with hydronephrosis or non-functioning kidneys are stage III unless these are known to be from another cause.</p>	<p>Radiation with concurrent chemotherapy is the primary mode of treatment.</p>	
<p>IV: Cancer extends beyond the true pelvis or involves the mucosa of bladder/rectum.</p> <p>IVA: adjacent pelvic organ spread</p> <p>IVB: distant spread</p>	<p>These patients require highly individualized treatment based on the exact spread of disease.</p>	<p>Radiation and/or chemotherapy may be considered, tailored for the individual disease pattern.</p>	<p>Patients with IVB (widely metastatic disease) may benefit from concurrent or solely palliative care.</p>
<p>Recurrence after primary surgical treatment</p>	<p>Determined by expert consultation</p>	<p>If localized, there may be a role for radiotherapy or chemoradiation.</p>	
<p>Recurrence after primary radiation treatment</p>	<p>Determined by expert consultation</p>	<p>If localized, there may be a role for surgical/exenterative therapy.</p>	

Sources:

Barakat RR, Berchuck A, Markman M, Randall ME. Principles and practice of gynecologic oncology, 6th edition. Philadelphia (PA): Wolters Kluwer/Lippincott Williams & Wilkins; 2013.

Wiebe E, Denny L, Thomas G. Cancer of the cervix uteri. Int J Gynaecol Obstet. 2012;119 (Suppl 2):S100–9. doi:10.1016/S0020-7292(12)60023-X.

Annex 11. Sample documents²⁹

A11

Annex 11. Sample documents

Sample Form 11.1: Sample letter to patient with an abnormal screening test who did not return for results or treatment at the expected time

Date: _____

Dear _____ [patient name],

We are writing to remind you to come in to _____ [health centre/hospital] to discuss the results of the screening test [OR get treatment for the positive screening test] you had on _____ [date of screening test]. We were hoping you would come in last week but since you have not returned, we are sending you this reminder.

Your screening test showed some abnormal changes on your cervix (entrance of the womb) requiring you to make another visit for _____ [further diagnosis/treatment]. (*If Pap abnormality is not invasive cancer, you may add: The changes are not indicative of cancer but, if left untreated, they may develop into cancer in the future.*)

We request that you come as soon as possible in the next two weeks so that we can give you all the information, answer any questions and plan further consultations with you.

If you have any questions, please contact us at _____.

Yours sincerely,

_____ [provider]

²⁹ Source: Adapted from Cervical Health Implementation Project (CHIP), University of Cape Town, University of the Witwatersrand, EngenderHealth. Implementing cervical screening in South Africa, volume I: a guide for programme managers. South Africa: CHIP, National Department of Health; 2004 (http://www.westerncape.gov.za/text/2006/1/chp_manual_vol_1.pdf).

Sample Form 11.2: Sample card that can be used as part of a system to track patients who need a repeat screening test

Cervical screening

Tracking card: Patient recall for screening test

Name: _____

Patient number: _____

Date of birth: _____

Home address: _____

Work address: _____

Telephone number: _____

Date screening test done: _____

Screening test result: _____

Date when client was asked to return: _____

Follow-up:

Date of repeat screening test: _____

Action taken if she did not return: _____

Note sent (date): _____

Other action: _____

Notes:

Sample Form 11.3: Sample card that can be used as part of a system to track patients referred for further diagnostic evaluation

A11

Annex 11. Sample documents

Cervical screening

Tracking card: Patient referral

Name: _____

Patient number: _____

Date of birth: _____

Home address: _____

Work address: _____

Telephone number: _____

Date screening test done: _____

Screening test result: _____

Appointment for referral at: _____ [name of referral site]

Date of referral appointment: _____

Tracking record:

Date patient informed of referral appointment: _____

Outcome of referral: _____

Sample Form 11.4: Sample letter informing referring clinic of the outcome of a patient's diagnostic evaluation

To: _____ [name of referring clinic]

Name of patient: _____ Patient number: _____

From: _____ [name of referral site]

Patient was seen in our facility on (date): _____

Diagnostic tests of _____ were performed on (date):

Final diagnosis: _____

Management provided _____

Recommended follow-up: _____

Thank you for your referral. Please contact us should you need further information.

Yours sincerely,

Name Signature Date

Annex 12. Treatment of cervical infections and pelvic inflammatory disease (PID)³⁰

Treatment of cervical infections

In case of a cervical infection, the woman and her partner should be treated and counselled on condom use.

Treatment for uncomplicated gonorrhoea and for chlamydia		
Coverage	First choice Choose 1 from each box below (= 2 medicines)	Special situation: pregnancy, breastfeeding or under 16 years old Choose 1 from each box below (= 2 medicines)
Gonorrhoea*	ceftriaxone* 250 mg by intramuscular injection as a single dose cefixime 400 mg orally as a single dose	cefixime 400 mg orally as a single dose ceftriaxone 250 mg by intramuscular injection as a single dose
Chlamydia	azithromycin 1 g orally as a single dose doxycycline^a 100 mg orally twice a day for 7 days	erythromycin^b 500 mg orally 4 times a day for 7 days azithromycin 1 g orally as a single dose amoxicillin 500 mg orally 3 times a day for 7 days

* The information in the table reflects WHO recommendations for treatment of cervical infections in 2011. These recommendations are being updated because of a high level of resistance of *Neisseria gonorrhoea* to quinolones and emerging decreasing susceptibility to cefixime and ceftriaxone (extended spectrum cephalosporin). Countries should be advised to take into consideration antimicrobial resistance patterns in *N. gonorrhoea* and follow national guidelines.

- Doxycycline, tetracycline, ciprofloxacin, norfloxacin and ofloxacin should be avoided in pregnancy and when breastfeeding.
- Erythromycin estolate is contraindicated in pregnancy because of medicine-related hepatotoxicity; only erythromycin base or erythromycin ethylsuccinate should be used.

³⁰ Source: Management of sexually transmitted infections: regional guidelines. New Delhi: World Health Organization Regional Office for South-East Asia; 2011 (<http://www.searo.who.int/entity/hiv/documents/9789290224105/en/>).

Outpatient treatment for PID

In case of PID, the woman's partner should be treated for gonorrhoea and chlamydia, and the couple should receive counselling on condom use.

Single-dose therapy for gonorrhoea PLUS multidose therapy for chlamydia PLUS multidose therapy for anaerobic infections	
Coverage	Choose 1 from each box (= 3 medicines)
Gonorrhoea*	ceftriaxone^a 250 mg by intramuscular injection as a single dose cefotixin 2 g by intramuscular injection as a single dose
Chlamydia	doxycycline^b 100 mg orally twice a day for 14 days erythromycin^c 500 mg orally 4 times a day for 14 days
Anaerobes	metronidazole^d 400–500 mg orally twice a day for 14 days

* The information in the table reflects WHO recommendations for treatment of cervical infections in 2011. These recommendations are being updated because of a high level of resistance of *Neisseria gonorrhoea* to quinolones and emerging decreasing susceptibility to cefixime and ceftriaxone (extended spectrum cephalosporin). Countries should be advised to take into consideration antimicrobial resistance patterns in *N. gonorrhoea* and follow national guidelines.

- May consider increasing the dose based on resistance pattern of *N. gonorrhoea* in country (check with national guidelines)
- Doxycycline is contraindicated for pregnant or breastfeeding women. PID is uncommon in pregnancy.
- Erythromycin estolate is contraindicated in pregnancy because of medicine-related hepatotoxicity; only erythromycin base or erythromycin ethylsuccinate should be used.
- Patients taking metronidazole should be cautioned to avoid alcohol.

Note: Hospitalization of patients with acute PID should be seriously considered when:

- a surgical emergency, such as appendicitis or ectopic pregnancy, cannot be excluded
- a pelvic abscess is suspected
- severe illness precludes management on an outpatient basis
- the patient is pregnant
- the patient is an adolescent
- the patient is unable to follow or tolerate an outpatient regimen
- the patient has failed to respond to outpatient therapy.

Annex 13. How to make Monsel's paste

A13

Annex 13. How to make Monsel's paste

What is Monsel's paste?

Monsel's paste is a thick, sticky, fast-acting compound that is used to cover bleeding areas on the cervix to stem the flow of blood. It can be useful after cryotherapy, punch biopsy and loop electrosurgical excision procedure (LEEP). As it is a caustic product that can damage tissues if left too long, no vaginal packing should be used after application.

Ingredients	Quantity
1. Ferric sulfate base	15 g
2. Ferrous sulfate powder	a few grains
3. Sterile water for mixing	10 ml
4. Glycerol starch (see preparation on next page)	12 g

Preparation:

Take care, as the reaction is exothermic (emits heat).

1. Add a few grains of ferrous sulfate powder to 10 ml of sterile water in a glass beaker. Shake.
2. Dissolve the ferric sulfate base in the solution by stirring with a glass stick. The solution should become crystal clear.
3. Weigh the glycerol starch (see preparation instructions below) in a glass mortar. Mix well.
4. Slowly add the ferric sulfate solution to the glycerol starch, constantly mixing to get a homogeneous mixture.
5. Place in a 25-ml brown glass bottle.

Note: Most clinics prefer to leave the stopper of the bottle loose, to allow the mixture to evaporate until it has a sticky paste-like consistency and looks like mustard. This may take 2–3 weeks, depending on the environment. The top of the bottle can then be secured for storage. If necessary, sterile water can be added to the paste to thin it.

<p>Label: Monsel's paste Store in a cool place For external use only Use by: [day/month/year] (one year from date of preparation)</p>

How to make glycerol starch

Ingredients	Quantity
1. Starch	30 g
2. Sterile water for mixing	30 ml
3. Glycerine	390 g

Preparation:

1. In a china crucible, dissolve the starch in the sterile water.
2. Add the glycerine. Shake well.
3. Heat the crucible and its contents over a Bunsen burner. Mix constantly with a spatula until the mass takes on a thick, swelling consistency.

Label: Glycerol starch

Store in a cool place

For external use only

Use by: [day/month/year] (one year from date of preparation)

Note: Do not overheat, otherwise the mixture will turn yellow.

Annex 14. Pathology reporting for cervical carcinoma

A14

Annex 14. Pathology reporting for cervical carcinoma

Radical hysterectomy for cervical carcinoma

1. Specimen processing:

- Paint the anterior and posterior surfaces of the cervix with different colour markers.
- Measure the vaginal cuff anterior and posterior before dissection.
- A horizontal slice through the cervix above the transformation zone is very helpful to assess excision margins. Blocks must extend to the inked excision line. Remember to record cassette numbers for relevant sides, etc.
- Para-sagittal and coronal sections through the ectocervix and vaginal cuff are required.
- Lymph nodes need to be submitted.

2. Record:

- The tumour type and grade (differentiation)
- The size of the tumour in three dimensions
- The dominant site of occurrence
- The depth of invasion and the distance to anterior, posterior, left and right parametrial excision lines
- The length of the vaginal cuff and whether or not the fornices are involved with either invasive tumour or CIN
- The presence or absence of vascular space invasion
- The number of lymph nodes examined for each side and the number involved with metastases.

Sample Form 14.1: Radical hysterectomy reporting form

Summary:

- Tumour type: _____
- Differentiation: _____
- Dominant situation: _____

- Size (maximum dimensions): _____ x _____ x _____ mm

- Greatest depth of invasion: _____ mm Situation: _____

- Distance from excision lines:

Anterior _____ mm Posterior _____ mm

Left _____ mm Right _____ mm

- Vaginal cuff: Anterior _____ mm Posterior _____ mm

- Lymph and/or vascular invasion:

Lymph nodes (number positive for metastases / number examined):

Left external iliac _____ Right external iliac _____

Left internal iliac _____ Right internal iliac _____

Left obturator _____ Right obturator _____

Others (specify) _____

Glossary

G

Glossary

Note: The definitions given in this glossary refer to the way words are used in this guide. Dictionary definitions may be more general and broader.

acetowhite: area on cervical epithelium that turns white when acetic acid is applied

adenocarcinoma: cancer with gland-like characteristics; for example, cancer arising from the columnar epithelium of the cervical canal

adjunctive therapy: another treatment used with the primary treatment to assist the primary treatment (see also: primary treatment)

adnexae: tissues and organs lateral to the uterus; include fallopian tubes, ovaries and ligaments

atypical cells: cells seen on a Pap smear that suggest an abnormality but are not conclusive

basement membrane: a thin layer of tissue that lies under the epithelium

biopsy: the removal of small samples of abnormal tissue for microscopic examination to achieve a diagnosis

bivalent: a vaccine that works by stimulating an immune response against two different antigens; e.g. Cervarix is a bivalent vaccine that helps protect the body against infection with HPV types 16 and 18, which cause most cases of cervical cancer¹

brachytherapy (or internal/implant radiation therapy): a type of radiation therapy in which radioactive material sealed in needles, seeds, wires or catheters is placed directly into or near a tumour²

carcinoma in situ (CIS): preinvasive stage of cancer involving the entire thickness of the covering layer, or epithelium, of an organ (e.g. the cervix) but not penetrating the basement membrane

CD4 count: CD4 (cluster of differentiation 4) are glycoproteins found on the surface of certain white blood cells (T cells); their count indicates the stage of HIV or AIDS in a patient

cervical intraepithelial neoplasia (CIN): a precancerous condition involving the covering layer (epithelium) of the cervix. It can be diagnosed using a microscope. The condition is graded as CIN1, 2 or 3, according to the thickness of the abnormal epithelium (one third, two thirds or the entire thickness)

¹ credit: adapted from United States National Cancer Institute (NCI) Dictionary of Cancer Terms (www.cancer.gov/dictionary)

² credit: NCI Dictionary of Cancer Terms

- cofactor:** a factor that contributes to or magnifies the effect of an agent that causes a change; usually not active on its own
- cold knife conization (CKC):** the removal of a cone-shaped area from the cervix, including portions of the outer (ectocervix) and inner cervix (endocervix), usually done in a hospital; the amount of tissue removed will depend on the size of the lesion and the likelihood of finding invasive cancer
- colposcopy:** the examination of the cervix, vagina and vulva with an instrument that provides strong light and magnifies a field, allowing specific patterns in the epithelial (surface) layer and surrounding blood vessels to be examined
- community mobilization:** a process of engaging communities and generating support for all those in need of health services, resulting in sustainable community ownership and participation
- computed tomography (CT) scan:** a radiographic imaging technique that creates a 3-dimensional view of the internal organs and tissues, which can be used to help diagnose disease, plan treatment, or find out how well treatment is working³
- condyloma (or anogenital warts):** a wart-like structure caused by low-risk HPV types; also seen in chronic syphilis
- cost-effective:** describes an activity or procedure that produces an adequate beneficial effect on a disease or condition in relation to its cost (in money, equipment, or time)
- counselling:** advice or guidance (usually one-on-one) from a knowledgeable person to facilitate personal decision-making; it is generally conducted privately and confidentially
- coverage:** the proportion of all targeted persons who attend a given service in a specified time
- cryotherapy:** by applying a highly cooled metal disc (cryoprobe) to the cervix and freezing the abnormal areas (along with normal areas) covered by it, cryotherapy eliminates precancerous areas on the cervix by freezing (i.e. it is an ablative method)
- cure rate:** the percentage of a group of persons with a disease or condition who are cured by a specific treatment
- cytology:** the study of the structure of cells under the microscope; abnormal findings are usually confirmed by biopsy
- cytopathologist/cytotechnician/cytologist:** persons trained in the microscopic examination of smears for the presence or absence of abnormal cells

³ credit: adapted from NCI Dictionary of Cancer Terms

dysplasia: cells that look abnormal under a microscope but are not cancer⁴

effectiveness: how well a treatment works to reduce a harmful condition in a target population

efficacy: the power of a given treatment to produce a desired effect

efficiency: the effects or results achieved in relation to the effort expended, in terms of money, resources and time

endocervical curettage (ECC): some surface cells are gently scraped from the endocervical canal with a special thin instrument or spatula; this is a simple procedure that takes just a few minutes

epidemiology: epidemiology is the study of the distribution and determinants of health-related states or events (including disease), and the application of this study to the control of diseases and other health problems

epithelium (plural: epithelia): a covering or lining, comprising one or more layers of cells; usually protective of the organ it covers

evaluation: the systematic and objective assessment of the relevance, adequacy, progress, efficiency, effectiveness and impact of a course of actions, in relation to objectives and taking into account the resources and facilities that have been deployed

exophytic: growing outwards

external-beam radiation therapy (or external radiation therapy, or teletherapy): a type of radiation therapy that uses a machine to aim high-energy rays at the cancer from outside of the body⁵

false negative: calculated from the sensitivity of a test; people who receive false-negative test results will not receive the treatment they need (because their positive status was undetected)

false positive: calculated from the specificity of a test; people who receive false-positive test results will receive unnecessary treatment

fistula: an abnormal passage between one hollow organ and another. With cervical cancer, fistulae may form between the vagina and the rectum, either as a result of extension of the cancer or as a late complication of radiation therapy

fungating: describes an irregular, outward, tumour growth pattern

gold standard: a test considered to have the highest sensitivity and specificity; used as a measure to compare all other similar tests

⁴ credit: NCI Dictionary of Cancer Terms

⁵ credit: NCI Dictionary of Cancer Terms

health education: an exchange of information with the purpose of increasing awareness and knowledge about how to keep healthy and prevent diseases, including information about resources that are available and the benefits of accessing services

high-grade lesion: a term used in the Bethesda classification to denote cervical abnormalities that have a high likelihood of progressing to cancer if not treated. Includes CIN2 and CIN3

high-risk HPV types (or oncogenic HPV types): types of the human papillomavirus (HPV) known to cause cervical cancer (also called oncogenic HPV types)

histology: the study of the microscopic structure of tissues; a histological examination uses thin slices of stained tissue to determine the presence or absence of disease

histopathology: the study of changes in tissues caused by disease; a histopathological examination uses the same methods as a histological examination, but is performed on biopsied samples of abnormal tissue

hysterectomy: surgery to remove the uterus and, sometimes, the cervix (when the uterus and the cervix are removed, it is called a total hysterectomy; when only the uterus is removed, it is called a partial hysterectomy)⁶

hysterotomy: a surgical procedure to make an opening in the uterus

immunocompetent: having the ability to produce a normal immune response⁷

immunosuppressed (or immunocompromised): having an impaired immune system – a reduced capacity to resist attack by germs and other foreign substances – e.g. as seen in people with HIV

incidence rate: the number of new cases of a disease in a defined population in a specified time, e.g. if there are 500 new cervical cancer cases every year in a country with 5 million women, the crude (non-age-standardized) cervical cancer incidence rate is 100 per million per year, or 10 per 100 000 per year

induration: hardening of a tissue, particularly the skin, caused by edema, inflammation or infiltration by a neoplasm⁸

infiltrating: invading inwards

⁶ credit: NCI Dictionary of Cancer Terms

⁷ credit: NCI Dictionary of Cancer Terms

⁸ credit: definition from Mosby's Medical Dictionary, 8th edition, Elsevier, 2009, cited in The Free Dictionary online (medical-dictionary.thefreedictionary.com)

intravenous pyelogram (IVP): an X-ray exam of the urinary tract (kidneys, bladder and ureters – the tubes that carry urine from the kidneys), which is made visible by using iodine contrast solution injected into a vein of the arm

koilocytosis: a condition of certain cells characterized by the presence of vacuoles around the cell nucleus

laparoscopy: a procedure that uses a laparoscope (a thin, tube-like instrument with a light and a lens for viewing), inserted through the abdominal wall, to examine the inside of the abdomen

laparotomy: a surgical incision in the abdomen

loop electrosurgical excision procedure (LEEP): the removal of abnormal areas from the cervix and the entire transformation zone, using a loop made of thin wire powered by an electrosurgical unit; the loop tool cuts and coagulates at the same time, and this is followed by use of a ball electrode to complete the coagulation

magnetic resonance imaging (MRI): a procedure in which radio waves and a powerful magnet linked to a computer are used to create detailed pictures of areas inside the body (better images than with CT scan or X-ray), which can show the difference between normal and diseased tissue⁹

menarche: the age at which a young woman has her first menstruation

metaplasia: a transformation of tissue from one type to another, e.g. from squamous to columnar epithelium

metastasis (plural: metastases): the appearance of a tumour, very similar to the original or parent tumour, in a distant organ

microinvasive cervical cancer: cancer strictly confined to the cervix, not more than 5 mm deep and 7 mm wide; it can only be diagnosed by microscopy

monitoring: the continuous oversight of an activity to assist in its supervision and to see that it proceeds according to plan; it involves the specification of methods to measure activity, use of resources, and response to services against agreed criteria

morbidity rate: the proportion of a population who suffer from a particular disease in a specified time, often expressed as number of cases per 100 000 population per year

mortality rate: the proportion of a population who die from a particular disease in a specified time, often expressed as number of deaths per 100 000 population per year

⁹ credit: adapted from NCI Dictionary of Cancer Terms

negative predictive value (of a test): the likelihood of not having the disease when the test is negative

neoplasia: process of new growth or tumour formation, sometimes malignant

oncogenic: having the potential or capacity to cause the growth of cancer cells/tumours

opioid: a type of drug used to relieve strong pain, e.g. morphine

outreach: efforts made beyond the walls of the health facility to reach target populations with the goals of increasing knowledge about specific health issues and improving access to health services

parametrium: the area between the uterus and the pelvic wall

pathology: the study of disease and its effect on body tissue

peritoneum: a continuous thin sheet of tissue covering the abdominal walls and organs

persistent: describes lesions or diseases that do not disappear over a certain time

pilot study: a demonstration project in a limited population; it usually aims to provide information on performance but not necessarily on outcome (which needs to be tested in a large population)

positive predictive value (of a test): the likelihood of having a disease when a test is positive

prevalence rate: the proportion of persons in a defined population with a condition or disease at a specific point in time

primary prevention: actions to avoid exposure to the principal causes of a disease; in the case of cervical cancer, prevention of HPV infection

primary treatment (or primary therapy): treatment that is usually tried first to attempt to cure a disease or condition

prognosis: a forecast of the outcomes of treatment based on experience with many cases of the same disease stage treated in the same way

quadrivalent: a vaccine that works by stimulating an immune response against four different antigens; e.g. Gardasil is a quadrivalent vaccine that helps protect the body against infection with HPV types 6, 11, 16 and 18¹⁰

¹⁰ credit: adapted from NCI Dictionary of Cancer Terms

radiotherapy (or radiation therapy): invisible rays (high-energy radiation) are beamed onto the cancer and the surrounding affected areas; the rays penetrate the body and destroy cancer cells so that the cancer is fully or partially eliminated – destroyed cancer cells are eliminated from the body

recurrence (of lesions, disease): the reappearance of a problem that had previously disappeared with treatment

regression: the disappearance or lessening of an abnormality

reliability or reproducibility: the extent to which a treatment or test gives the same results when repeated many times

screening: a public health intervention provided to an asymptomatic target population; it is not undertaken to diagnose a disease, but to identify individuals with increased probability of having either the disease itself or a precursor of the disease

screen-negative: result of a screening procedure that shows no abnormality

screen-positive: result of a screening procedure that shows an abnormality

secondary prevention: a level of preventive medicine that focuses on early diagnosis, use of referral services, and rapid initiation of treatment to stop the progress of disease processes or a handicapping disability¹¹

secondary treatment (or secondary therapy): a treatment that can be given after another (primary) treatment has been used

sensitivity: the proportion of people who have a condition who are identified correctly by a test (true positives).

specificity: the proportion of people who do not have a condition who are correctly identified by a test (true negatives)

squamocolumnar junction (SCJ): The junction between the glandular epithelium and squamous epithelium on the cervix is the squamocolumnar junction; it is part of the transformation zone¹² (see also: transformation zone)

squamous intraepithelial lesion (SIL): pre-cancer or abnormality of the squamous cells of the lining of the cervix. The Bethesda classification distinguishes between low-grade SIL (LSIL) and high-grade SIL (HSIL). This classification should be used only for reporting results of cytological tests

¹¹ credit: definition from Mosby's Medical Dictionary, 8th edition, Elsevier, 2009, cited in The Free Dictionary online

¹² credit: Mukonoweshuro P, Oriowolo A, Smith M. Audit of the histological definition of cervical transformation zone. J Clin Pathol. 2005;58(6):671.

survival rate: the proportion of all the people with a condition who are still alive after a certain time

syncope: fainting

syndromic treatment: an approach to the treatment of infection based on knowledge of the principal causes of the presenting symptoms; for example, cervical infection can be treated with antibiotics against both gonorrhoea and chlamydia, without first performing other tests to diagnose which of the two pathogens is present

teletherapy: see: external-beam radiation therapy

tertiary prevention: a level of preventive medicine that deals with the rehabilitation and return of a patient to a status of maximum usefulness with a minimum risk of recurrence of a physical or mental disorder¹³

trachelectomy: surgical removal of the uterine cervix, without removal of the uterine fundus

transformation zone: the cervical transformation zone is a dynamic entity formed during puberty; it is the area where the glandular epithelium is being replaced by squamous epithelium¹⁴ (see also: squamocolumnar junction)

true negative: calculated from the specificity of a test; people who receive true-negative test results do not need treatment and will not receive treatment

true positive: calculated from the sensitivity of a test; people who receive true-positive test results will receive the treatment they need

ulcerating: eating into tissue and causing a shallow crater; describes some cancers

¹³ credit: definition from Mosby's Medical Dictionary, 8th edition, Elsevier, 2009, cited in The Free Dictionary online

¹⁴ credit: Mukonoweshuro P, et al. (2005)

For more information, please contact:

Department of Reproductive Health and Research
World Health Organization
Avenue Appia 20, CH-1211 Geneva 27, Switzerland
Fax: +41 22 791 4171
E-mail: reproductivehealth@who.int

www.who.int/reproductivehealth

ISBN 978 92 4 154895 3



9 789241 548953